



This is a digital copy of a book that was preserved for generations on library shelves before it was carefully scanned by Google as part of a project to make the world's books discoverable online.

It has survived long enough for the copyright to expire and the book to enter the public domain. A public domain book is one that was never subject to copyright or whose legal copyright term has expired. Whether a book is in the public domain may vary country to country. Public domain books are our gateways to the past, representing a wealth of history, culture and knowledge that's often difficult to discover.

Marks, notations and other marginalia present in the original volume will appear in this file - a reminder of this book's long journey from the publisher to a library and finally to you.

Usage guidelines

Google is proud to partner with libraries to digitize public domain materials and make them widely accessible. Public domain books belong to the public and we are merely their custodians. Nevertheless, this work is expensive, so in order to keep providing this resource, we have taken steps to prevent abuse by commercial parties, including placing technical restrictions on automated querying.

We also ask that you:

- + *Make non-commercial use of the files* We designed Google Book Search for use by individuals, and we request that you use these files for personal, non-commercial purposes.
- + *Refrain from automated querying* Do not send automated queries of any sort to Google's system: If you are conducting research on machine translation, optical character recognition or other areas where access to a large amount of text is helpful, please contact us. We encourage the use of public domain materials for these purposes and may be able to help.
- + *Maintain attribution* The Google "watermark" you see on each file is essential for informing people about this project and helping them find additional materials through Google Book Search. Please do not remove it.
- + *Keep it legal* Whatever your use, remember that you are responsible for ensuring that what you are doing is legal. Do not assume that just because we believe a book is in the public domain for users in the United States, that the work is also in the public domain for users in other countries. Whether a book is still in copyright varies from country to country, and we can't offer guidance on whether any specific use of any specific book is allowed. Please do not assume that a book's appearance in Google Book Search means it can be used in any manner anywhere in the world. Copyright infringement liability can be quite severe.

About Google Book Search

Google's mission is to organize the world's information and to make it universally accessible and useful. Google Book Search helps readers discover the world's books while helping authors and publishers reach new audiences. You can search through the full text of this book on the web at <http://books.google.com/>

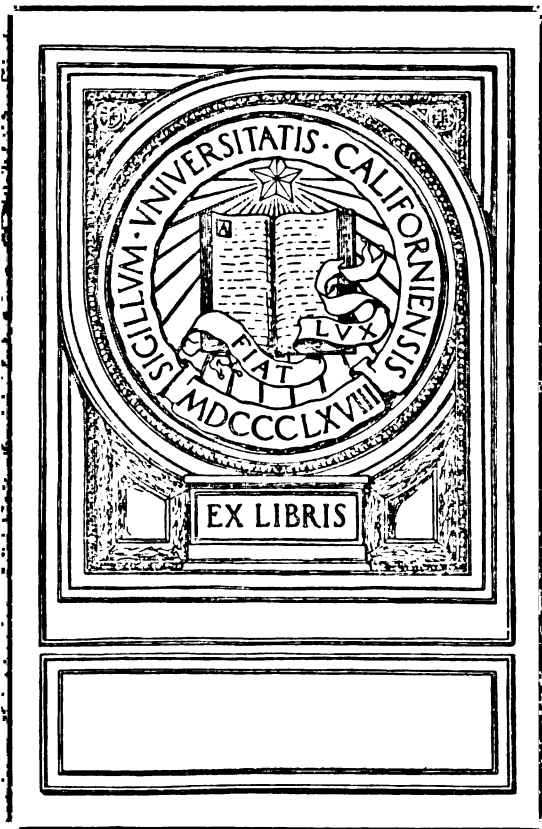

EX LIBRIS

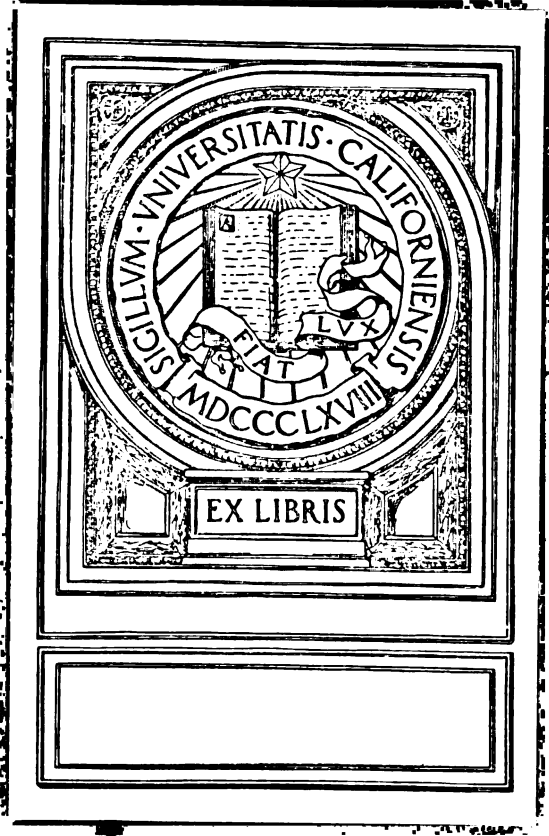

EX LIBRIS



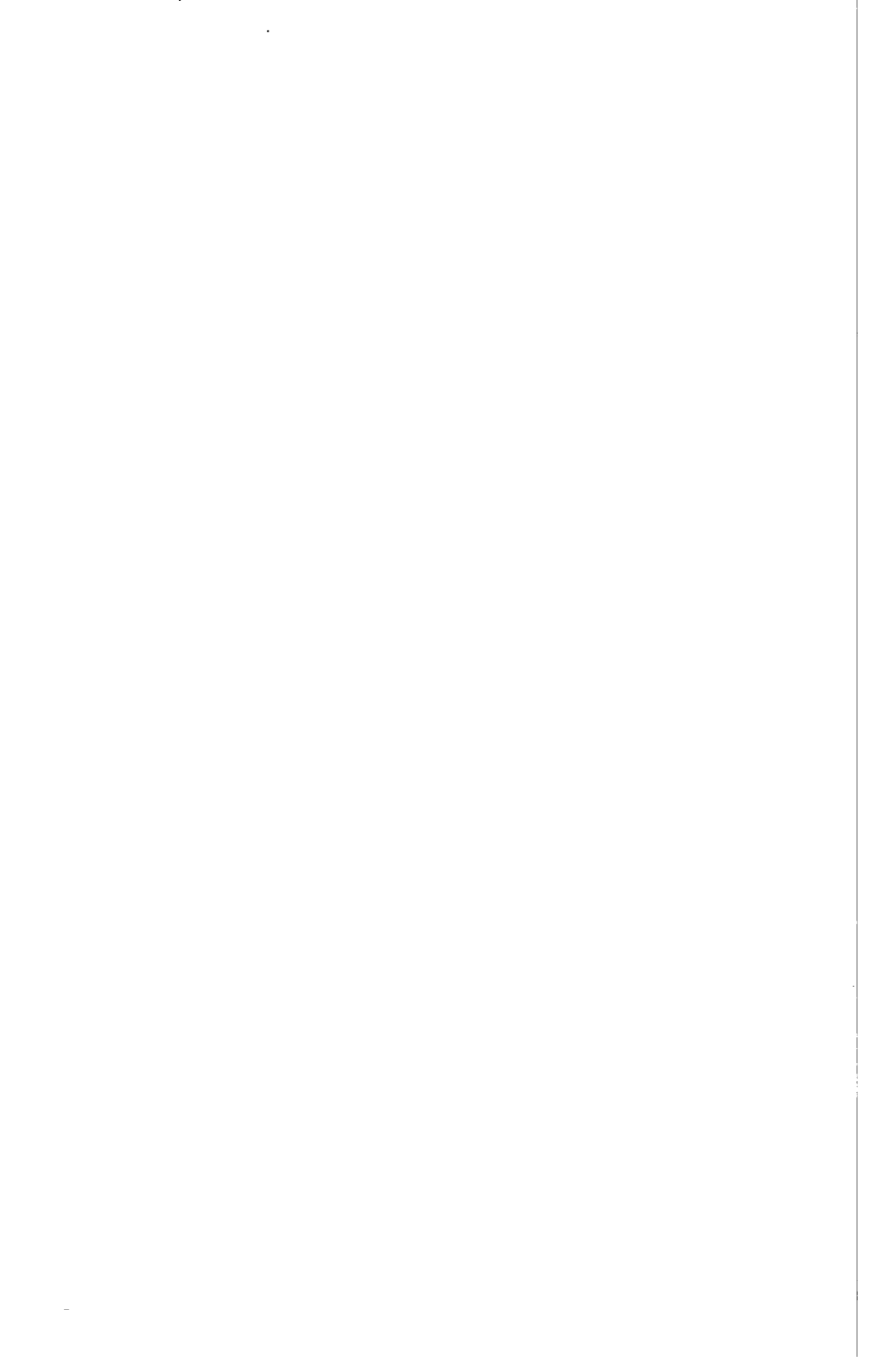

IRON, STEEL, AND OTHER ALLOYS

BY

HENRY MARION HOWE, LL. D.

**Professor of Metallurgy in Columbia University
in the City of New York**

Second and Slightly Revised Edition



Published by
ALBERT SAUVEUR
Cambridge, Mass., U. S. A.

1906

GENERAL

Copyright, 1906, by
ALBERT SAUVEUR

Langages Printing Company, New York

TO MY FRIEND
PROFESSOR DIMITRY CONSTANTIN TSCHERNOFF
THE FATHER OF THE METALLOGRAPHY OF IRON
As a token of affectionate esteem, this work is dedicated

ERRATA

P. 49, 5th line from bottom, *for æolic read* eutectoid.

P. 50, 1st line of title, *for Æolic read* Eutectoid.

2d line of title, *for Hypo-æolic read* Hypo-eutectoid.

PREFACE

THE heterogeneousness of this book is due to its being intended for several different though related classes of readers. It was undertaken originally for the use of my students, to supplement the instruction given by lectures and by other books. This it aimed to do by elaborating certain important matters which are not treated at sufficient length if, at all in other text-books, and are not well suited to lecture-room exposition. Of these students there are at least three distinct classes: those who are to study metallurgy very superficially, the students in chemistry and civil, electrical, and mechanical engineering; those who are to study it more thoroughly, the students in metallurgy and mining engineering; and those whose work is to go still farther, the advanced students.

But the very fact of writing a book fitted for these classes was an opportunity to go a little farther and meet the needs of practitioners, by giving them a systematic account of the condition of the metallography of iron to-day, and more particularly to expose to them the present or solution theory of that metallography. This seemed very important, both because this theory for the first time permits us to take a comprehensive and consistent view of the whole subject, and because for the majority of English-speaking practitioners an account is needed at once more elementary and fuller than any which is now accessible to them.

These different classes of readers bring to the subject very different kinds of preparation; and it is this difference in preparation which has led to vary the treatment, so as to fit each part to the supposed needs of the particular class, or more often classes, of readers to which it seemed likely to be useful.

My warmest thanks are due to the friends who have aided me with their counsel and knowledge. In particular let me thank most sincerely Professor Margaret E. Maltby for examining the first seven chapters and the tenth, those relating to the genesis of alloys in general and to the phase rule; Mr. Frank Firmstone for examining the chapter on the blast-furnace; and Dr. William Campbell, non-resident lecturer on metallurgy, for much invaluable information, for many of the micrographs, and indeed for the original suggestion to write the book; though as to the last my gratitude is somewhat mingled with reproach.

To the fellow officers of my department I am indebted for much valuable aid, particularly to Messrs. Bradley Stoughton, instructor in metallurgy, and I. C. Bull, assistant.

To nobody am I more indebted than to my assistant, Mr. R. W. Page, for his painstaking and intelligent aid in preparing the work and in passing it through the press.

The reader should have tolerantly in mind the difficulty of preparing a work to-day dealing with the metallography of iron, with our knowledge at once so fragmentary and so rapidly growing. To keep the work fully up to every latest development of this knowledge would mean publishing it on the Greek kalends.

H. M. H.

COLUMBIA UNIVERSITY
IN THE CITY OF NEW YORK
June 3, 1903

PREFACE TO THE SECOND EDITION

IN preparing this edition, besides making a few minor corrections and other changes, I have added the classification and definitions of iron and steel which Professor Sauveur and I made for the International Association for Testing Materials; I have described and discussed the Roe puddler, the Mond gas-producer (very briefly), and the Gayley dry-blast process; and rewritten the part relating to the transition substances, martensite, troostite, and sorbite. Here a puzzling question arose. In a view of the fact that, of the students for whose use this work is chiefly designed, twenty would hereafter practice civil, mining, mechanical engineering or chemistry, for every one who would practice metallurgy, ought I to complicate further this already very complex subject by insisting on the part played by the still hypothetical *beta* iron, or simplify it by slurring over this allotropic form, and treating these transition substances as simply mechanical mixtures, in varying proportions and varying states of aggregation, of the three known primary substances, austenite, ferrite and cementite? I have followed the latter course, though not without grave misgivings.

H. M. H.

COLUMBIA UNIVERSITY
IN THE CITY OF NEW YORK
February 12, 1906

TABLE OF CONTENTS

CHAPTER I.—INTRODUCTORY

SECTION	PAGE
1. Introduction	I
2. Possible Components of Alloys	2
3. Resemblance of Metals to Rock-masses	5
4. Chemical Compounds among Metals	8
5. Solid Solutions	9
6. Isomorphous Mixtures and Mixed Crystals	11
7. Solid Solutions may be Heterogeneous	13
8. Methods of Study of the Constitution of Alloys	13
9. Microscopic Examination	14

CHAPTER II.—COOLING CURVES

10. Physical Properties of Individual Alloys — Cooling Curves	17
11. Definition of Mother-liquor and Mother-metal	19
12. Other Inflections in Cooling Curves	19
13. Distortions of Cooling Curves	20
14. Surfusion	20
15. Malobservation	20
16. Ease of Thermal Studies	23
17. Selective freezing	24
18. Definition of Selective Freezing	24
19. Other Features of Cooling Curves	25
20. Freezing Covers a Considerable Range	26
21. Selection Naturally to be Expected	26
22. Selective and Unselective Freezing	28
23. The Jog and the Eutectic	28
24. Freezing of a 20-Per Cent Salt Solution	29
25. Freezing of a Eutectic Solution	30
26. Freezing of a Hyper-eutectic Solution	30
27. Eutectic and Cryohydrate	31
28. Properties of the Eutectic	31
29. Reasons for the Properties of the Eutectic	33
30. Surfusion	35
31. Why the Eutectic is Composite	38
32. Why the Eutectic is Not of Simple Atomic Proportions	39

SECTION	PAGE
33. Arrival at Eutectic Composition and Freezing-point are Simultaneous	39
34. Eutectic Plus Excess	39
34A. Precaution as to the Term "Excess-substance"	40
35. The Excess-freezing and the Eutectic-freezing Periods	40
35A. Reasons for the Spherulitic Structure of Certain Eutectics	41
35B. Influence of the Structure of the Eutectic	43
36. Many Alloys Parallel with the Salt-water Series	43
37. Stratification According to Density	44
38. Microstructure	46
39. Definition of Idiomorphic	51

CHAPTER III.—FREEZING-POINT CURVES

40. Physical Properties of Series of Alloys, or the General System in which the Changes in any Given Critical Point or Critical Composition Occur as we Pass from one End of a Series to its Other End	52
41. Freezing-point Curve	52
42. Twofold Aspect of the V-Curves	53
43. Prolongation of the V-Curves beyond their Apex	54
44. Other Critical Curves for Temperature and Composition	57
45. Freezing-point Curve of Salt Water	58
46. Cooling and Freezing-point Curves Shown Simultaneously	59

CHAPTER IV.—CONSTITUTION OF BINARY ALLOYS WHICH FORM NO DEFINITE CHEMICAL COMPOUND

47. Constitution to be Expected in Certain Typical Cases	59
48. If two Metals are Insoluble in Each Other when Solid, all their Alloys Should Be Eutectiferous	62
49. Why Such a Series is Eutectiferous Throughout	62
50. Why this Eutectic is Composite	63
51. Series of Alloys Rarely Eutectiferous Throughout	63
52. If two Metals are Soluble in Each Other when Solid, some or even all of their Alloys Should Be Non-eutectiferous	64
53. Six Features of the Genesis and Constitution of wholly Non-eutectiferous Series: Silver-gold Type	64

Reasons for this Genesis and Constitution

54. Freezing Selective, but the Selection Should Not Be Rigid	65
55. These Reasons Continued: Heterogeneousness of Solid Solutions	66

Table of Contents

ix

SECTION	PAGE
56. One Member of the Series a Eutectic	66
57. That Eutectic Not Composite	67
58. The Other Alloys of the Series Non-eutectiferous	68
59. Shape of the Cooling Curve	68
60. If the Reciprocal Solubility of two Metals when Solid is Limited, the Series of their Alloys Should be Eutectiferous in the Middle but not at its Ends, and the Eutectic Should be Com- posite	68
61. Subsaturation and Saturation Divisions of the Excess-freezing Period	69
62. Shape of the Cooling Curve	70
63. Microstructure	70
64. If the Layers Freezing Out Reach the Saturation-point before all the Mother-metal is Frozen, a Eutectic Should Form	72
65. That Eutectic Should Be Composite	73
66. The Saturation Division	73
67. Freezing-point Curve of such Alloys	74
68. Boundaries of the Eutectiferous Range	74
69. Meaning and General Conditions of Equilibrium	75
70. Equilibrium in a Solid Binary Alloy, if the Reciprocal Solubility of the Component Metals is Limited. General Assumptions	77
71. Cases 1 and 2, Metal <i>B</i> is theoretically Capable of Dissolving the Whole of Metal <i>A</i> Present, when Both Are Solid	78
72. Case 3, There is more of each Metal Present than the other Metal is Theoretically Capable of Dissolving	79
73. If the two Solutions are Saturated, the System is in Equilibrium	80
74. The Constituents of the Eutectic Should Be Saturated with Each Other	84
75. The Structure to be Expected from these Conditions in a Eutectiferous Alloy	85
76. Segregation	86
77. Abnormal Segregation	87
78. Modifications of this Structure	88
79. The Deposition is in Layers, though in Distorted ones	92
80. Landlocking Type of Deposition	93
81. Segregation is both Microscopic and Macroscopic	94
82. Progressive Variation in the Microscopic Segregation	97
83. Approach towards one or the other of these Types	99
83 <i>A</i> . Conditions Affecting the Degree of Residual Segregation	99
84. Diffusion Tends to Lessen this Segregation	100
85. Diffusion Lessens both Microscopic and Macroscopic Segrega- tion	101
86. How Complete is Diffusion?	101
87. Freezing Differentiates, Diffusion Equalizes	102
88. Rapid Freezing Should Lessen Segregation	102
89. In Particular, Rapid Freezing Should Restrain Macroscopic Segregation	106

SECTION	PAGE
90. The Two Features of Rapid Cooling through the Freezing-range, Taken Jointly	107
91. Taking the Two Periods Jointly, what Procedure in Freezing-plus-Cooling should Yield the Least Residual Segregation?	108
92. Case 1, The Rate of Cooling is Artificially Variable	109
93. Case 2, The Rate of Cooling is Natural, <i>i. e.</i> , not Artificially Variable	110
94. Other Modes of Growth	113
95. Diffusion is in Both Directions from the Shore Line	113
96. The Rate of Freezing and that of Subsequent Cooling May Shift the Apparent Boundaries of the Eutectiferous Range	113
97. Solubility Falls with the Temperature	115

CHAPTER V.—OTHER SERIES CURVES OF BINARY ALLOYS FORMING NO CHEMICAL COMPOUND

98. Saturation-point or So-called Critical Curves. General Assumption	116
99. Saturation-point Curves in Solid Metal (1) Non eutectiferous Alloys	118

Position of the Saturation-point Curve under Various Conditions and its Relation to the Freezing-point Curve

100. Case 1, The Saturation-point Curve Lies wholly Below the Freezing-point Curve	119
101. Case 2, The Two Metals are Completely Insoluble in Each Other at All Temperatures, both when Solid and when Molten	119
102. Case 3, The Two Metals are Wholly Insoluble in Each Other at All Temperatures When Solid, but Soluble in Each Other in All Proportions and at All Temperatures When Molten	120
103. Cases in which the Saturation-point Curve Meets or Cuts the Freezing-point Curve	120
104. Case 4, For the Molten State Reciprocal Solubility is Unlimited at All Temperatures, but in the Freezing-point Range it is Limited for the Solid State	120
105. In This and All Like Cases the Saturation-point Curves Pass Through the Normal or Equilibrium Boundaries of the Eutectiferous Range	121
106. Case 5, For the Molten State Reciprocal Solubility is Complete Only Above a Certain Range	121
107. Subcase 5A, the Saturation-point Curve Cuts the Two Upper or V-Branched of the Freezing-point Curve at the same Temperature	121

Table of Contents

xi

SECTION	PAGE
108. Subcase $5A\beta$. The Two Metals when Solid are Somewhat Soluble in Each Other	125
109. Relative Position of the Saturation-point Curve for the Solid and Molten States	126
110. Subcase $5B$, the Saturation-point Curve Cuts the Two Upper or V-Branched of the Freezing-point Curve at Different Temperatures	126
111. Subcase $5B\beta$. The Two Metals When Solid are Somewhat Soluble in Each Other	132
112. Determination of the Saturation-point Curves for the Solid State	133
113. Determination of the Saturation-point Curves for the Molten State	134
114. The Course of Selection. Temperature-composition Curve of the Frozen Continent during Selective Freezing	135
115. Reasons for this Curve	138
116. Temperature and Composition of the Frozen Part and the Molten Mother-metal during Selective Freezing. Non-eutectiferous Alloy, Metals G and H	139
117. Barely Non-eutectiferous Alloy of Metals G and H	141
118. Position of the Extremities of Temperature-composition Curve for the Frozen Part	141
119. Eutectiferous Alloy of Metals G and H	142
120. Summary of the Foregoing	143
121. Temperature-composition Curve of the Layers in the Act of Deposition	144
122. The Same Curve for a Eutectiferous Alloy	144
123. Correspondence between the Cooling Curve and the Temperature-composition Curve of the Freezing Layers	145
124. No Gap in the Saturation-point Curve	145

CHAPTER VI.—COOLING CURVES AND FREEZING-
POINT CURVES OF SERIES CONTAINING
DEFINITE CHEMICAL COMPOUNDS.

126. Series of which One Alloy is a Definite Chemical Compound	148
127. Series of which Several Members are Definite Chemical Compounds	149
128. Meaning of Superior Analysis	151

CHAPTER VII.—VARIATIONS IN ELECTRIC CONDUCTIVITY AND OTHER PROPERTIES OF SERIES OF ALLOYS

SECTION	PAGE
129. Electric Conductivity	152
130. Thermo-electric Power	154
131. Electric Conductivity at the Common Temperature	154
132. Solid Solutions	154
133. Series Eutectiferous Throughout	155
134. Series of Limited Mutual Solubility: Bismuth-tin Type, Partly Eutectiferous	156
135. Series of which One Member is a Definite Chemical Compound	158
136. Other Properties	159
137. Electromotive Force	159

CHAPTER VIII.—THE METALLOGRAPHY OF IRON AND STEEL

138. Introduction	160
139. General Survey	160
140. General Classification of Iron and Steel	167
141. Division into Three Great Classes According to Carbon-content	167
142. Definitions	170
143. Carbon and Iron	171
144. Source of the Confusion in our Nomenclature	173
145. The Microscopic Constituents of Iron and Steel	174
(1) Ferrite	175
146. (2) Cementite	175
147. (3) Pearlite	176
148. Eutectoid	176
149. (4) Austenite	177
Transition Forms:	
Martensite	179
Troostite	180
Sorbite	181
150. (5) Graphite	181
151. (6) Slag	181
152. (7) The Eutectic	182
153. Calculation of the Constitution or Proximate Composition of Slowly Cooled Steel, and other Stoichiometric Calculations	182
154. Summary	188
155. Division of Iron into Three Series According to Microscopic Constitution	188
156. Pearlite Series	189
157. The Graphite-pearlite or Gray Cast-iron Series	189
158. This Conception Tested	190

Table of Contents

xiii

SECTION	PAGE
159. The Austenite Series	191
160. Uses of the Austenite Series	192
161. The Austenite Never Pure	193
162. Freezing-point Curves and Transformation Curves of the Iron-carbon Compounds	193
163. Position of the Steel Cast-iron Boundary as Related to the Saturation-point of Solid Austenite	195
164. General Division; Constitution; Lag	195
165. Region I, <i>ABCF</i> , Molten Solution of Carbon in Iron	197
166. Region II, <i>AaB</i> , Selective Freezing Occurs, Molten Carburetted Iron and Solid Austenite	197
167. Region III, <i>CBc</i> , Selective Freezing Occurs, Molten Carburetted Iron and Graphite	198
168. Region IV, <i>AaESHK'G</i> , Austenite	198
169. Region V, <i>GHSP</i> , Selective Transformation Occurs, Austenite and Ferrite	198
170. Region VI, <i>PSH'O</i> , Pearlite and Ferrite resulting from Reaction (9)	199
171. Region VII, <i>aERC</i> , 2 per cent Austenite and Graphite resulting from Reaction (4)	199
172. Region VIII, <i>ESP'R</i> , Selective Transformation Occurs, Austenite and Cementite	200
173. Region IX, <i>SP'fK'</i> , Pearlite and Cementite	202
174. Summary	202
175. The Freezing-point Curve, <i>ABC</i> , <i>aBc</i> ; its General Features	202
176. Regions IV and VII, Constitution of Iron at 1050° in the Different Ranges of Composition	204
177. (2) The Eutectic	204
178. (3) Region VII. Eutectiferous or Cast Iron Range	205
179. Genesis of this 1050° Constitution	206
180. (1) 4.30 per cent. Eutectic cast iron	206
181. (2) 1.00 per cent. Steel of 1 per cent of carbon	207
182. (3) 2.50 per cent. The cooling of hypo-eutectic cast iron	207
183. (4) 5.00 per cent. The cooling of hyper-eutectic cast iron	208
184. Conditions Affecting the Quantity of Graphite Formed	208
185. The Role of Silicon	210
186. Areas IV to VII Inclusive. Transformation Curves, <i>GHSE</i> , <i>PSP'</i>	211
187. Genesis of this Constitution	212
188. (1) Eutectoid Steel, 0.90 per cent carbon	212
189. (2) Hypo-eutectoid Steel, 0.50 per cent carbon	212
190. (3) Eutectoid Steel, 1 per cent carbon <i>r'W</i>	213
191. Different Allotropic States	214
192. Special Nomenclature of the Transformation Curves, <i>GHSE</i> , <i>PSP'</i>	215
193. Properties of the Allotropic States	215
194. Transformation Parallel with Freezing	216

**CHAPTER IX. — THE HEAT-TREATMENT OF STEEL
AND CAST IRON**

SECTION	PAGE
195. The Heat-treatment of Steel and Cast Iron	217

*Processes Operating Chiefly Through Control of the Proximate
Constitution*

196. Deformations of the Cooling Curves by Lag	218
197. The Recalescence	219
198. The Hardening and Tempering of Steel	221
199. The Hardening Increases as the Quenching Temperature Rises through the Critical Range, but it is Independent of the Tem- perature above that Range	223
200. The Hardening Increases with the Rapidity of Cooling with- out Limit	225
201. Like Phenomena in Allotropic Changes	225
202. Simile to the Struggle between Transformation and Resistance	228
203. Evidence Supporting this Theory	229
204. The Tempering of Hardened Steel	230
205. The Annealing of Hardened Steel	231
206. A Simile to Explain Tempering and Annealing	231
207. Why the Rate of Cooling after Tempering is Immaterial	234
208. Verification of the Loss of the Hardening Power at the Re- calescence	235
209. Stress in Hardened Steel	236
210. Simile to Explain Internal Stress	237
211. Stress may Weaken or Strengthen	237

*The Heat-treatment of Steel, Processes Operating Chiefly
Through Control of the Structure*

212. Importance to the Engineer	241
213. Heat-refining Defined	242
214. The Structure of Iron and Steel	242
215. A Coarse Fracture Suggests a Coarse Structure	244
216. General Laws Concerning Structure and Temperature	245
217. Heat-refining	251
217A. To find the Temperature of Heat-refining	255
217B. Stead's Brittleness	255
218. Burning	257
218A. Why do not Ingots and other Castings Burn in Cooling through the Burning Range?	260
219. Mechanical Refining	262
219A. Finishing Temperature	264

Table of Contents

xv

SECTION	PAGE
219B. Further Consideration of the Influence of T^{\max} on the Physical Properties	267

The Heat-treatment of Cast Iron

220. The Heat-treatment of Cast Iron	276
221. The Reactions which should Theoretically Occur in Freezing and Cooling of such a Cast Iron	277
222. Reactions in Freezing and Cooling of Typical Gray Cast Iron	277
223. Reactions in the Freezing and Cooling of Typical White Cast Iron	278
224. Reactions in the Freezing and Cooling of Typical Ultra Gray Cast Iron	278
225. The Chilling of Cast Iron	279
226. The Annealing of Chilled Castings	280
227. Manufacture of Malleable Castings	281

CHAPTER X.—THE PHASE RULE

228. In General	283
229. The Value of the Phase Rule	285
230. Meaning of Equilibrium	285
231. An Example of Unstable Equilibrium	286
232. Stable Equilibrium	288
233. Behavior on Reheating a Criterion of Stability	288
234. Reversibility and Lag	289
235. Hardened Steel Illustrates Irreversibility	290
236. Why Irreversibility Implies Absence of Equilibrium	291

Terminology of the Phase Rule

237. Component and Phase	293
238. Examples of Component and Phase. A. The Components are Elements	294
239. B. Examples in which the Components are Chemical Compounds	295
240. Allotropic Modifications are Distinct Phases	297
241. Composite Eutectics are not Phases	297
242. Homogeneous Phases	297
243. Physical Actions	298
244. Independently varying Conditions	298
245. Arbitrary and Conformable Variations in Condition	298
246. Degree of Liberty: The Phase Rule	299
247. Examples to Test the Phase Rule	300

SECTION	PAGE
248. Tin in the Act of Freezing	302
249. Water in the Act of Freezing	303
250. Salt-water above the Freezing-point	303
251. Salt-ice	303
252. Lead-tin Alloy in the Act of Selective Freezing	304
253. The same Lead-tin Alloy (Composition G) at the Freezing-point of the Eutectic	307
254. The Iron-carbon Compounds	309
255. The Phase Rule Applies only to Systems Properly So Called	310
256. The Phase Rule in one Aspect is Qualitative, not Quantitative	311

CHAPTER XI.—PROGRESS IN THE MANUFACTURE OF IRON AND STEEL BETWEEN 1880 AND 1900

257. Summary	313
258. Alloy Steels	316
259. Nickel Steel	316
260. Manganese Steel	317
261. Chrome Steel	323
262. Tungsten Steel	324
263. Molybdenum Steel	325
264. Deep Carburizing; Harvey and Krupp Processes	325
265. General Scheme of Iron Manufacture	325
265A. Classification of Processes	329

Extraction of Iron from its Ores

266. The Blast-furnace Process	330
267. The Handling of Raw Materials	331
268. Handling the Molten Cast Iron	332
269. Preservation of the Furnace Walls	336
270. Blast-furnace Gas Engines	337
271. Hot-blast Stoves	338
272. The Increase in the Rate of Production	342

Conversion into Wrought Iron and Steel

273. Manufacture of Wrought Iron	343
274. The Puddling Process	344
275. The Open-hearth Process	347
276. The Siemens Furnace	350
277. New Varieties of the Open-hearth Process	354
278. The Bertrand-Thiel Process	355
279. The Talbot Process	355
280. The Monell Process	356

Table of Contents

xvii

SECTION	PAGE
281. The Bessemer Process	356
282. Direct Metal and the Mixer	357
283. The Car-casting System	358
283A. Increase in the Rate of Production of a Pair of Bessemer Con- verters	361
284. Range in Size of Converters	361
285. The Basic Bessemer Process	362
286. Darby's Recarburizing Process	364
287. Comparison of Processes	365

Mechanical Treatment

288. Defects in Steel Ingots	366
289. Pipes, Sauveur's Process	366
290. Blowholes	368
291. Segregation	372
292. "Draft" Fluid Compression of Steel Ingots	373
293. Heating Furnaces	375
294. The Continuous Rolling-mill	378
295. Hammers and Hydraulic Presses	379

Statistics

296. Cost of Manufacture	380
297. Increase in Production	380

CHAPTER XII.—THE BLAST-FURNACE

298. The Blast-furnace	384
299. Chief Functions of the Blast-furnace	388
300. Functions of the Fuel	391
301. Chemical Reactions in the Blast-furnace. Reduction of the Iron	391
302. The Metallurgical Management of the Blast-furnace	392
303. Importance of the Deoxidizing Tendencies	392
304. Means of Regulating the Strength of the Deoxidizing Action	396
305. The Hearth Temperature	398
306. Influence of the Slag Melting-point on the Hearth Temperature	399
307. Regulation of Melting-point of Blast-furnace Slag by Means of its Composition	402
308. Direct Chemical Effect of the Lime-content of the Slag	405
309. The Effect of Most Variables on the Silicon-content is the Opposite of that on the Sulphur-content	406
310. Relative Promptness of Different Methods of Raising the Hearth Temperature	406

CHAPTER XIII.—METALLURGICAL GAS FURNACES

SECTION	PAGE
311. Gas-firing and Direct-firing	407
312. Direct-firing	407
313. Gas-firing	408
314. Kinds of Gas Used in Metallurgy	408
315. Purpose of Gasification	409
316. The Advantages of Gas-firing	411
317. Temperature and Character of Flame under Better Control	411
318. Fuel Economy	414
319. Comparison of Regenerative and Recuperative Furnaces	416
320. The Siemens System Catches the Heat on the Right Side	417
321. The Value of Gas Regeneration	418
322. The Progressive Rise in Temperature in Regenerative Furnaces	422
323. The Siemens Gas Producer	423
324. The Taylor Gas Producer	425
325. The Duff Gas Producer	428
326. The Use of Steam in the Producer	429
APPENDIX I	
327. Further Note on the Constitution of Gray Iron, Case 1	431
328. Case 2	431
329. Case 3	433
330. Case 4	434
331. Actual Genesis of White and Gray Cast Iron	435
332. General Diagram of the Constitution and Properties of Cast Iron of 4.00 per cent Carbon	437
APPENDIX II	
333. Classification of Iron and Steel	440
334. Definitions of the Various Classes of Iron and Steel	442
335. The Boundary between Steel and Iron	447
APPENDIX III	
336. The Magnetic Properties	447
APPENDIX IV	
<i>Some Metallurgical Novelties</i>	
336A. Roe's Rocking Puddling Furnace	449
337. The Mond Gas Producer	453
338. The Gayley Dry-blast Process	457
339. Reasons for the Fuel Saving	458
340. Discussion. Importance of Initial Gas Temperature in Heating Processes with a Critical Temperature	460
341A. Equation 35 Tested	463
341B. Importance of the Critical Temperature in the Blast-furnace Process	467
342. Note on Sorbite and the Other Stages of Transition between Austenite and Pearlite	475

IRON, STEEL, AND OTHER ALLOYS





IRON, STEEL, AND OTHER ALLOYS

CHAPTER I.—INTRODUCTORY

I. INTRODUCTION. — Beside the general interest which we have in understanding the constitution of alloys, as giving us an intelligent view of the matter in general, we have the special reason that a knowledge of the subject promises to be of the greatest practical value in approaching the study of any given series of alloys, for instance to one seeking to learn what are the most valuable alloys of two given metals. The case reminds us of the calculus. If we have the formula of a given curve before us we can by means of the calculus discover where all the critical points of that curve will lie without going to the trouble of plotting it throughout. Somewhat so is it with the examination of the constitution of a series of alloys, say those of bismuth with tin, or antimony with copper. The constitution of such a series may be expected to vary from one end of the series to the other; but in passing thus from end to end of the series there may be important critical points, at which not only the constitution changes but the nature of that change itself changes abruptly. Such points may be called critical points for constitution. And, just as the calculus reveals to us the critical points of a curve of known formula, so it happens that these critical points for constitution may often be laid bare by means of a few easy experiments.

Now the importance of this lies in the fact that the critical points for constitution may be expected to be also critical points for the useful properties. If we seek ductility, we may expect to find a critical point for ductility in that part of the series where lies a critical point for constitution: there we may expect to find either a maximum or a minimum of ductility; and so with many other useful properties.

Thus it is that the methods which promise to reveal to us with relative ease the probable constitution of a series of alloys of any two metals, of learning where its critical points lie, and indeed whether it has any critical points, thereby promise to teach us where in that series we shall probably find those alloys the properties of which will differ markedly for better or for worse from those of the component metals; and indeed, whether or not we are likely to find any alloys in the series which do differ markedly in their physical properties from the component metals. The knowledge of the constitution of a series of alloys in short gives us a method of superior analysis of the problem of where to find in that series the most valuable alloys. These indications, of course, are not conclusive; indeed we have still far more to learn of their meaning than we yet know; but already they are of great value as in pointing out the part of the field most likely to be fruitful.

2. POSSIBLE COMPONENTS OF ALLOYS. — In inorganic matter we have three important classes of substances:

- (1) pure elements,
- (2) definite chemical compounds of those elements, and
- (3) solutions.

In the same way we recognize in our alloys three classes of ultimate constituents:

- (1) pure metals,
- (2) definite chemical compounds of those metals with each other, such as AuAl_2 , antimonide of copper ($\text{Cu}_8\text{Sb}_3?$), and antimonide of tin (SnSb), and also to a smaller certain extent definite chemical compounds of metals with the relatively small quantities of certain metalloids, such as carbon and sulphur, present in some alloys. In this latter class of compounds the most important is the carbide Fe_3C found in steel, and commonly called "cementite,"

(3) what are now called solid solutions of metals in each other, a term the meaning of which will be explained in § 5, p. 9. Suffice it for the present that we have in our alloys these three classes, corresponding to the three great classes into which inorganic matter in general is divisible.

Any given piece of an alloy may at the same time contain substances of each of the three classes.

Here as in so many other respects the alloys remind us of the

crystalline rocks, which they resemble in the general conditions of their formation. Crystalline rocks have cooled either like most of our alloys from a state of fusion, or at least from a temperature so high that the atoms present in the rock-mass have been free to arrange themselves, to combine to form definite compounds, and these compounds have been free to obey their crystalline laws. Under the microscope we find that our rocks consist of three classes of substances:

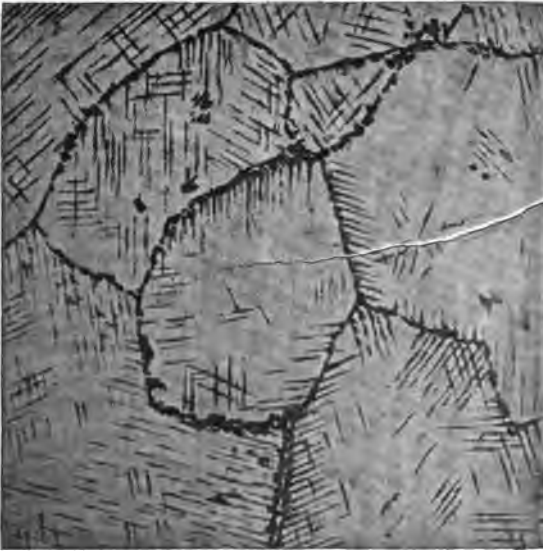

Fig. 1. Pearlite with Ferrite.

The polygons are pearlite, the network is ferrite.

(Sorby, *Journ. Iron and Steel Inst.*, 1887, I, p. 255 *et seq.*, Fig. 13.)

- (1) pure metals, such as native copper, native gold, *etc.*,
- (2) definite chemical compounds, like feldspar, mica, quartz, hornblende, and
- (3) glass-like obsidians, in which the chemical elements are united, not in any definite ratio, but indeterminately.

Just as the particles of these different substances, the feldspar and other minerals, often exist in such minute particles that they can be detected only under the microscope, so in most cases the components of our alloys are visible only under the micro-

scope, and often only with very great magnification, which may sometimes have to reach a thousand diameters. Fig. 1 gives us an idea of a common type of structure among our alloys, and it will be seen that it is strikingly like that of the crystalline rocks shown in Fig. 2.

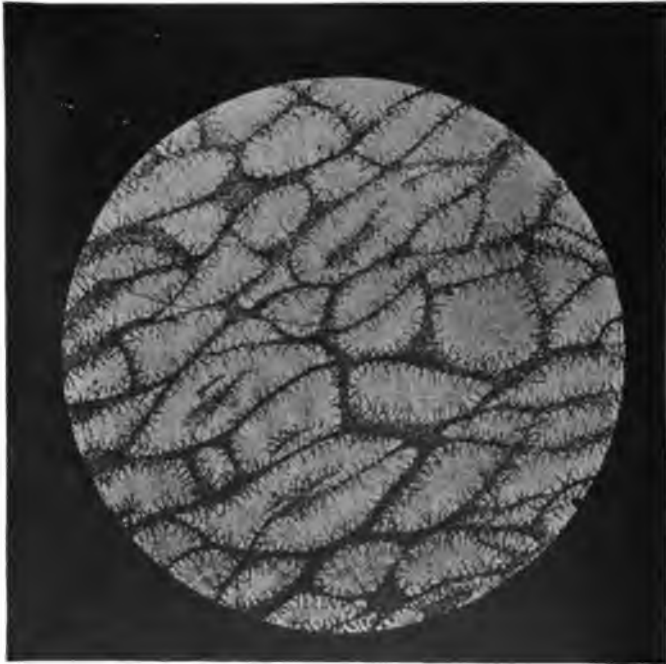

Fig. 2. Structure of Igneous Rock.

(Rhyolite from Hot Spring Hills, Pah-Ute Range.)
"U. S. Geological Exploration of the Fortieth Parallel, VI,
Microscopical Petrography," Plate VIII, Fig. 1.

The resemblance between alloys and crystalline rocks does not stop here. Indeed we find close analogies between our metals on one hand and our crystalline rocks on the other, both of which result from the gradual solidification of fused or semi-fused masses; and also between both of these classes of solids and those which, like ice, result from the solidification of aqueous

solutions instead of fused masses. Let us notice some of these points of resemblance.

3. RESEMBLANCE OF METALS TO ROCK-MASSSES. — First the columnar structure familiar to us in the Palisades of the Hudson, the Giant's Causeway, and like rock-masses, forming enormous columns, we find reproduced both in metals and in ice. The



Fig. 3.

Columnar Structure in Steel Ingot,
from the Author's Collection,
actual size.



Fig. 4.

A, superficial
blowholes;
B, deep-seated
blowholes;
C, pipe.

columns of the Palisades were formed during the slow cooling of the rock-mass which they form; and they stand upright, *i. e.*, with their length at right angles with their upper surface, which was the cooling surface, the surface through which the heat escaped from them while they were cooling down and changing from a molten glass or obsidian to a solid rock. We find in



Fig. 5. Steel Crystal, about half natural size.
From the collection of Professor Tschernoff. (*The Metallgraphist*, II, p. 74.)

slowly cooled metals this same columnar structure, with the columns standing at right angles with the cooling surface, *i. e.*, with the outer surface, as is shown in Fig. 3; and in large blocks of ice, especially in the ingots of artificial ice which we see about the streets, we can often trace this columnar structure, with the

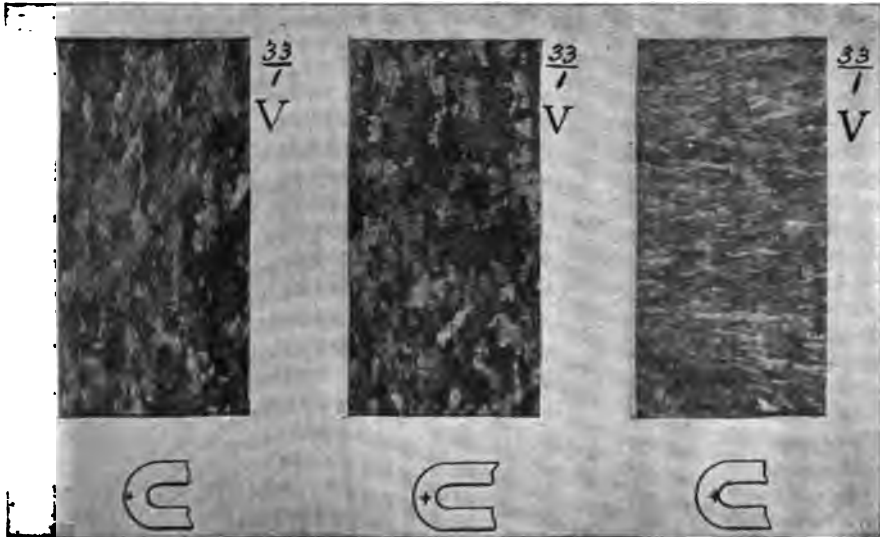

From the outside (extrados) of the bend. The polygons (crystals) of ferrite are lengthened, parallel with the extrados.

From near the neutral fibre. The polygons of ferrite are little changed in shape but are crossed by slip-lines.

From the inside of the bend. The polygons of ferrite now lie normal to the extrados.

Fig. 6. Schistosity Developed in Low-carbon Steel by Bending.
Steel Containing: Carbon 0.035; Manganese 0.025.
Made by J. A. Mathews, Ph.D., in the Author's Laboratory.

columns at right angles with the cooling surface, *i. e.*, with the sides of the ice-ingot.

Next we find in solidified ingots of steel a contraction-cavity called a "pipe" at the upper end of the axis of the ingot (Fig. 4); and you will generally see a similar pear-shaped cavity in the upper end of the ingots of artificial ice about the streets.

Next the beautiful specimens of minerals which adorn our mineralogical cabinets generally form in the cavities or "vugs" as they are called in the rocks; beautiful crystals of iron at times occur also in the cavities in our steel ingots (Fig. 5); and in the same way we will often find most beautiful minute crystals of ice in the pear-shaped pipe of our common ingots of artificial ice.

Again, just as the crumpling of the rocks of the earth's crust produces what is known as a schistose structure, so we find such a structure (Fig. 6) in masses of iron when they have been crumpled in like manner.

Finally, gases evolved during solidification cause gas-bubbles or "blowholes" in ingots of ice and of steel, and also in glass (*A* and *B*, Fig. 4). These blowholes form at a time when the mass is still fluid enough to be pushed aside by the particles of gas evolved within it, so that these come together to form gas-bubbles; yet not fluid enough to permit these bubbles to rise by gravity to the upper surface and thus escape. So these bubbles remain entangled in the viscous mass.

4. CHEMICAL COMPOUNDS AMONG METALS.—While the condition of the particles of pure metals which we find in our alloys calls for no special comment here, that of the chemical compounds and of the solid solutions requires a word.

The chemical compounds of one metal with another do not in general follow the law of valence, so that they are of the type known as "molecular." The law of valence retains its importance, but we must recognize that it is not a universal one. We may, however, make the important generalization that obedience to the law of valence is typical of a great number of our strong chemical compounds, those in which the atoms are powerfully united, yielding a compound which differs greatly in its properties from those of its components. And it is in accordance with this general idea that even the definite chemical compounds of one metal with another, as of copper with antimony, or gold with aluminium, or tin with antimony, as they do not follow the law of valence, are feebly combined, and that their properties differ from those of their component metals in a very much less degree than is the case with the common strong chemical compounds with which we are familiar in inorganic chemistry. The properties of water are wholly different from those of hydrogen and oxygen; the properties of common salt give no suggestion of

those of either chlorine or sodium. Naturally we find no such striking difference between the properties of a definite compound of aluminium with gold on one hand, and the properties of aluminium and of gold respectively on the other.

5. **SOLID SOLUTIONS.** — What do we mean by this term? We use the word solution here to distinguish these substances from solid definite chemical compounds. We mean by solid solutions those solids which are to definite solid chemical compounds, like salt, what liquid solutions, like salt water, are to liquid definite chemical compounds, like pure water itself. We mean solids which have the essential characteristics of solutions so far as solidity itself permits.

To understand this let us ask what are the essential properties which distinguish our common liquid solutions from definite chemical compounds. In a definite chemical compound we have two essential features, (1) complete and absolute merging of the components into a new and different substance, chlorine and sodium losing their identity absolutely and forming a wholly different substance, common salt; and (2) a mathematically fixed ratio between the two components. In the case of solution, while this fixed-ratio feature is lacking, we have this same complete merging of the two substances. In a solution of water and alcohol we can neither by the microscope nor by any other means detect either the water or the alcohol; they unite to form a new substance: neither gravity nor centrifugal force separates them; the light alcohol does not rise to the surface, nor does the heavier water sink. This complete merging of their components and the absence of fixed ratio between those components, then, are the two essential characteristics of our common liquid solutions.

As the chemical forces which hold the dissolved bodies together in the new substance, the solution, are relatively feeble, naturally the properties of the solution do not differ markedly from the mean of the properties of the two bodies dissolved in each other.

Turning to the solid state we find in our glasses a similar state of affairs, except that the glasses are solid while common solutions are liquid. The silica, lime and alkali of the glass are absolutely merged; neither the microscope nor any other means enables us to detect either silica or lime or alkali as a separate en-

tity in the glass, so long as it remains a glass. Only when we destroy it, tearing it asunder by analysis, can we detect any of its components. We have then in the glass a chemical merging of the components; but it is in indefinite ratios. The percentage of silica or of lime can vary by infinitesimal gradations from specimen to specimen, and this variation is accompanied by corresponding progressive change in the physical properties. The change from specimen to specimen, then, both in composition and in properties, is per gradum; whereas the changes from one definite chemical compound to another, from water to hydrogen peroxide for instance, are per saltum. The glasses then have these two essentials of solutions, the substances present are (1) completely merged, but (2) in indefinite proportions.

In the same way many of our metals, as it were, dissolve in each other, and we find them in the solidified state completely merged in each other, forming alloys which differ from specimen to specimen by infinitesimal gradations, and yet the component metals cannot be distinguished in the alloy by the microscope or by any other means. The separate individual existence of each has ceased. Here then we have the essential characteristics of solutions, *viz.*, (1) complete merging of the components (2) in indeterminate proportions; and on this account we give to these substances the name "solid solutions."

And just as the properties of the liquid solution, its color, density, electric conductivity, *etc.*, do not differ markedly from those of the mean of its components, so we find that the physical properties in general of those alloys which are solid solutions do not differ markedly from the mean of the properties of the metals which compose them.*

*The author has found this conception of solid solutions so hard for many students to grasp that, for their sake and at the risk of seeming to most readers needlessly explicit, some further discussion, line upon line, seems desirable. When chlorine and sodium unite to form salt, the two elements lose their identity completely, they are completely merged. A wholly new substance arises, salt, having little resemblance to either of its components. They have become one; they cannot be separated or distinguished from each other so long as they are united. Neither the microscope nor gravity nor centrifugal force nor any other purely mechanical force separates them or enables us to distinguish one from the other. It is this complete sinking of their individual identity, this birth of a new substance, in which neither of the component sub-

6. ISOMORPHOUS MIXTURES AND MIXED CRYSTALS. — Solid solutions are called by some "isomorphous mixtures" and by some "mixed crystals." The term "isomorphous mixtures" would naturally be suggested by the fact that the familiar cases of two definite inorganic compounds which crystallize together to form homogeneous crystals, the molecules of each substance practically entering into and completely identifying themselves with the molecules of the other, are cases in which the two substances are isomorphous, *i. e.*, when by themselves they yield crystals of the same form, *i. e.*, "isomorphous" crystals. This property then of two different substances of merging their existence completely in single crystals, is one which we associate with isomorphous bodies, and this association easily leads to applying the word "isomorphous" to all cases of such identification and merging. But reflection shows us that the similarity of crystalline form, even were it not only a constant concomitant but

stances is distinguishable by any means whatever so long as this new substance remains undecomposed — it is this that we here call merging.

If we grind silica and magnetic iron oxide to the most impalpable powder and mix them with most extreme thoroughness, they still remain two distinct bodies, silica and iron oxide, merely intimately mixed mechanically. We can again separate them by appropriate mechanical means. Under a sufficiently powerful microscope we can still see the white particles of silica and the black ones of iron oxide. If we immerse them in a liquid heavier than the silica but lighter than the iron oxide, we separate them by gravity, the silica gradually rising to the top, while the iron oxide sinks to the bottom. Or we can separate them by means of a magnet.

But let us melt them together, and they unite and merge, they become one, and neither can now be distinguished by any means, nor separated mechanically from the other, so long as this merging remains.

Suppose that we have a room cooled to -40° C.; that in this we grind up ice and crystals of hydrated cupric sulphate (blue vitrol) quite as we ground up our silica and iron oxide; to simplify our ideas suppose that at this temperature the cupric sulphate and ice do not react on each other but remain separate quite as the silica and iron oxide do, and that we then mix them in a bottle with extreme thoroughness. They still constitute simply an intimate mechanical mixture; they are not merged; by sufficient magnification we can see under the microscope the transparent white particles of ice and the blue ones of cupric sulphate. By carefully tapping the bottle we can induce the heavy crystals of cupric sulphate to work their way down to the bottom of the bottle, leaving the lighter particles of ice above. Now let us heat the whole over the lamp, and soon the ice melts and dissolves the cupric sulphate. Now in this solution

a necessary condition of this merging, is clearly not its essence. We see no conclusive reason why two metals of different crystalline forms should not completely merge. Their union could not properly be called isomorphous, but it would properly be called a solid solution.

The chief reason, however, for preferring this latter term is that it is based, not on what could at most be a concomitant or necessary condition, but on the essential properties of this class of substances, the fact that they have all the prominent essential properties of aqueous solutions save their fluidity.

As to the expression "mixed crystals" it seems most unfortunate, because it is so liable to mislead, for it certainly would suggest to many a mechanical mixture. For instance, silver and gold dissolve in each other in all proportions, and the crystals of the two metals thus merged are spoken of by some as mixed crystals of silver and gold. This certainly will suggest to many that the mass is a conglomerate, a mechanical mixture of particles

we have no longer a mechanical mixture but absolute merging, merging as complete and as little broken up by mechanical means, as little capable of being resolved by the microscope, as the merging of our chlorine and sodium in salt or of our silica and iron oxide in our iron silicate.

Of course, we can by appropriate chemical means break this solution up; we can insert a sheet of metallic iron and precipitate the copper on it; we can break the solution up chemically; but so long as it remains a solution, the water and the cupric sulphate lack their independent existence as two separate entities mechanically mixed, and now form one entity different from either of its components. We may dispute as to the nature of this new entity, as to the nature of solutions; we may regard them as composed of ions or whatever we please; but that the solution is one whole, that in it the water and the cupric sulphate have merged their separate existence and have coalesced to form some kind of a new thing, and some one new thing, cannot be doubted. Let us leave out of sight completely our conceptions of the nature of solutions, and for the present satisfy ourselves with this idea of (1) the complete merging of the separate existence of the two components, the water and the cupric sulphate, in this new thing, the solution, (2) in indefinite ratios.

When we find that the constituents of a solid, such as the silica, lime and alkali of a glass, or the gold and silver of a silver-gold alloy, have thus completely merged and supk their separate individual existence in this one new body, the glass or the alloy; and when we find that the composition of this solid is not in definite chemical ratio but differs by infinitesimal gradations from specimen to specimen, we say that it has the essential characteristics of a solution so far as those characteristics are compatible with solidity itself; and we call the mass a solid solution.

of pure gold and particles of pure silver, which is exactly the opposite of the truth. Indeed, whether we speak of isomorphous "mixtures" or of "mixed" crystals, the idea of mixture leads the mind rather away from than towards the conception of merging, which is the essence of the matter; while "solution" in itself suggests merging.

7. **SOLID SOLUTIONS MAY BE HETEROGENEOUS.**—Liquid solutions, as we know, are habitually homogeneous, because in the liquid state diffusion takes place with considerable rapidity, so that even if a solution is initially heterogeneous, diffusion tends to make it homogeneous. From the conditions under which they form, however, and from the slowness of diffusion in the solid state, we should expect solid solutions to be heterogeneous. (See § 55, p. 66.)

8. **METHODS OF STUDY OF THE CONSTITUTION OF ALLOYS.**—As the science of petrography was in an advanced stage when that of metallography, of the constitution and structure of metals, was in its infancy, we naturally ask why the methods so fully developed for petrography have not been applied to metallography.

We may say that the essential procedure in petrography is to recognize the minute or even microscopic crystalline grains in our rock-masses by examining them with the microscope and with the polariscope, and by finding that they have the same crystalline form, and the same effect on polarized light, as the large crystals of the same minerals with which we are already familiar in the form of our cabinet specimens. Having determined accurately the crystalline form of quartz and its effect on polarized light by the study of large-sized cabinet crystals, we are able to recognize minute or even microscopic crystals of quartz by finding that they have the same crystalline form and the same action on polarized light. Manifestly, this method is wholly inapplicable to metallography. In the first place there are very few metals and alloys of which we have cabinet specimens suitable for standards with which to compare the crystalline form or other properties of the microscopic crystals which we find in our alloys.

Moreover, the metals and their alloys are opaque, so that the polariscope is wholly inapplicable. The discovery of the X-rays may have given rise to the hope that by them we could meet the difficulty of the opacity of our metals; but reflection

shows that this hope was vain. For in most cases the particles of the different components of our alloys are so exceedingly minute that any individual grain of crystal would occupy but an insignificant fraction of the thickness even of the thinnest possible section, so that any given X-ray, in passing through such a section, would pass not through one individual grain or crystal of a given component, but through many different superposed crystals of all the different components which were present. In this way the shape of each one would be completely obscured and eclipsed by that of the others, and the effect of any given particle upon the X-rays would be masked by the effect of the other crystals through which that same ray would pass. There are indeed a few cases in which the individual crystals are large enough to be thus outlined by the X-rays, but even in these cases the structure can be more readily detected by microscopic study of the surface after it has been properly prepared. Thus the X-ray method is without either present or prospective value.

The chief method actually used in metallography is to correlate the results of our examination (1) of the structure as revealed by the microscope, (2) of the physical properties of individual alloys, and (3) of the physical properties of series of alloys taken as a whole. The meaning of this third method I will make clear later. We will now take up these three methods of research consecutively.

9. MICROSCOPIC EXAMINATION.*—Many of our alloys, as has been already pointed out, have a granitic or porphyritic

* A. Sauveur, "Microscopical Examination of Iron and Steel," *Engineering and Mining Journal*, LXIV, p. 215.

A. Sauveur, "Mechanical Uses of the Science of Metallography," *Engineering Magazine*, XVII, p. 977.

Stead, "A Practical Lesson in the Preparation of Metal Sections for Microscopic Examination," *Proceedings South Staffordshire Institute*, Session 1896-97, XII, p. 2.

Stead, "Practical Metallography," *The Metallographist*, III, p. 220.

F. Osmond, "Méthode Générale pour l'Analyse Micrographique des Aciers au Carbone," *Bulletin Société d'Encouragement pour l'Industrie Nationale*, May, 1895. See preferably the reprint in the "Contribution à l'Étude des Alliages, Commission des Alliages," 1896-1900, p. 277.

F. Osmond, "La Métallographie Considérée comme Méthode d'Essai," *Baumaterialienkunde*, II, No. 4.

Sir Wm. Roberts-Austen, "On Photomicrography of Steel Rails,"

structure; that is to say, like a granite they are composed of distinct grains, each grain being some one distinct entity, and of a distinct mineral species; and the different grains are of two or more different species. In the case of common granite there are grains of three different mineral species, mica, quartz and feldspar, lying side by side; and any individual grain is of some one of these species.

Now, the composition of granite taken as a whole is indeterminate, in the sense that, if we take a series of different granites and determine their ultimate composition, we find that the percentage of silica or of lime varies by irregular gradations from one specimen to the next; and the percentage of these components might vary by infinitesimal gradations from one granite to the next. But, though the composition of granite is in this sense wholly indeterminate, and though there is thus no possible composition of which we may say "This is the true composition of granite"; yet each of the several minerals which compose the granite, the mica, quartz and feldspar, is a perfectly definite chemical compound with definite physical properties.

So many of our alloys are granitic or porphyritic. They are found by the microscope to consist of grains or crystals of different definite substances. Each grain is of some one of these substances, and these different unlike grains lie side by side, like the mica, quartz and feldspar of a granite. The substances which compose these different grains in our granitic or porphyritic alloys may be (1) pure metals,* or (2) definite chemical compounds of two or more metals with each other in rigidly fixed atomic proportions, such as aluminide of gold (AuAl_2), antimonide of copper (Cu_3Sb_3 ?) and antimonide of tin (SnSb), compa-

Institution of Civil Engineers, January 17, 1899, Proceedings, CXXXVI, p. 174.

Le Chatelier, "La Technique de la Métallographie Microscopique," "Contribution à l'Étude des Alliages, Commission des Alliages," 1896-1900, p. 421.

* Pure metals are spoken of for simplicity, serving as a type; it is probable that, in most granitic alloys, the particles which may at first appear to be pure metals are in fact not quite pure; but that each apparently pure metal contains, dissolved in itself, a little, and perhaps a very little, of each of the other metals present.

rable with the chemical compounds with which we are familiar in common inorganic chemistry; or (3) definite chemical compounds of a metal with a metalloid, such as the iron carbide (Fe_3C) called *cementite*, which plays a very important part in the metallography of iron and steel; *etc., etc.* One aim of microscopic examination is to ascertain whether the alloy is of this porphyritic type and consists of different distinct crystals of definite chemical composition, or whether it is of the obsidian type consisting solely of a solid solution; or whether it contains both definite minerals and also solid solutions. The further aim is to distinguish the shape, size and the properties both physical and chemical of these various components.

The first step in general is to polish the metallic mass so that a large field may be visible under high magnification. The second is to subject it to an attack, either chemical or mechanical, which will affect the different constituents in different ways, and thus enable us not only to distinguish one from another but also to determine the shape, habit and properties of each. Of these methods five deserve mention here. Of these the first three are chemical, the fourth mechanical, and the fifth partly chemical and partly mechanical. They are as follows:

(a) *Simple attack* by some solvent such as nitric acid, iodine or licorice, a method which we owe to Sorby.* Such a method may dissolve away one component more than another, or color one component differently from another, or it may simply eat away the joints between adjacent grains of crystals, and thus disclose their shape when they are later examined under the microscope.

(b) *Weyl's Method*, which has received great development in the hands of Charpy, is to attack by means of a solvent under the influence of a very gentle electric current. Charpy uses as the two poles (1) the alloy which is under examination and (2) at times platinum and at times another alloy of a composition so nearly similar to the first that the electro-motive force shall be very feeble, and therefore that the attack shall be extremely gentle. This gentleness is needed in all our methods. The particles which we wish to recognize and identify are so extremely minute, and often so feebly held in place, that we must use the

* *Journal Iron and Steel Institute*, 1887, I, p. 256.

utmost gentleness, whether in dissolving or in mechanically separating one from the other, lest we remove mechanically those components which we seek to leave untouched.

(c) *Heat-Tinting*. The different constituents may be differently colored by gently heating the polished surface, so that the more oxidizable ones become covered with oxide tints. This method has been used by Guillemin, and later by Stead,* with most valuable results.

(d) *Relief Polishing*. Beyond these we have the mechanical methods, of which Osmond's "relief-polishing" is very important. By prolonged very gentle polishing, the softer constituents of a conglomerate alloy are worn away, leaving the harder ones standing in relief.†

(e) *Osmond's "attack-polishing"* combines the chemical and mechanical methods happily. He polishes the surface while it is exposed to a reagent which attacks or colors the different constituents differently, so that disintegration by the reagent and removal by the rubbing go hand in hand.

CHAPTER II.—COOLING CURVES

10. PHYSICAL PROPERTIES OF INDIVIDUAL ALLOYS. COOLING CURVES. — If we were studying the alloys of two metals, such as the alloys of silver with gold taken as a group, or those of lead with tin taken as a group, we should of course examine many of these alloys individually, in order to see to what degree it had the property toward which our study was particularly directed, be it hardness, tensile strength, conductivity, or whatever. But besides this, in order to learn the constitution of that individual alloy, we should in particular determine with great care its "cooling curve." Let an example explain what a cooling curve is. If we place a thermometer in a flask of pure water, and place that water in a freezing-mixture, and follow carefully the fall of

* *Journal Iron and Steel Inst.*, 1900, II, p. 137.

† F. Osmond, "Méthode Générale Pour L'Analyse Micrographique des Aciers au Carbone," *Bulletin de la Société d'Encouragement*, May, 1895. See preferably the reprint in the "Contribution à l'Étude des Alliages," 1896-1900, p. 277.

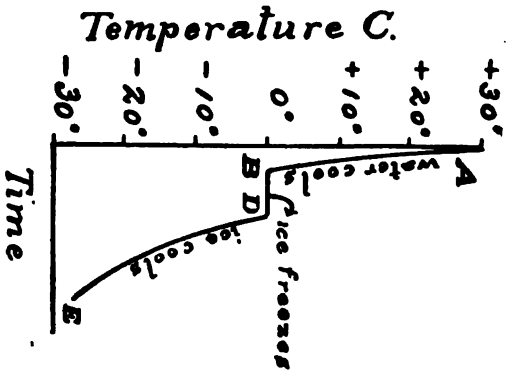

Fig. 7.
Cooling Curve of
Pure Water.

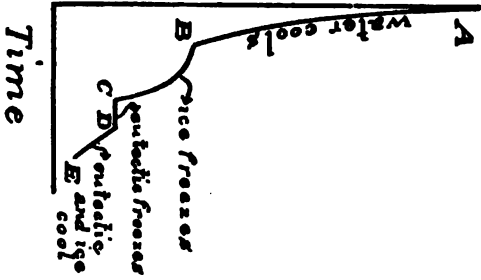

Fig. 8.
Cooling Curve of a 15 per
cent Salt Solution.

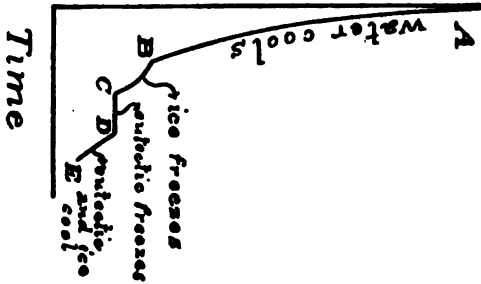

Fig. 9.
Cooling Curve of a 20 per
cent Salt Solution.

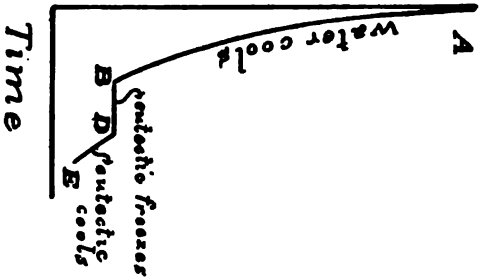

Fig. 10.
Cooling Curve of a 23.6 per
cent Salt Solution.

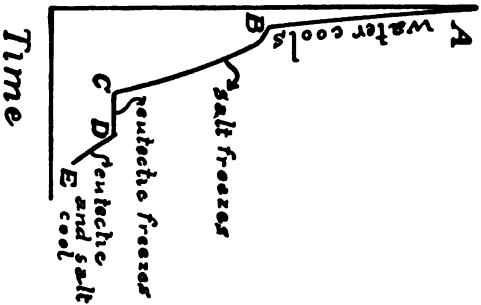

Fig. 11.
Cooling Curve of a 26.27
per cent Salt Solution.

temperature, plotting each degree of temperature as ordinate and time as abscissa, we should get a curve like that in Fig. 7.

As the temperature of the water progressively falling approaches that of the freezing-mixture, the fall of temperature will be slower and slower; and the curve will progressively become flatter and flatter (*AB*), but it will be smooth, *i. e.*, free from inflections and critical points until the temperature falls to 0° C. At this point the water will begin to freeze, and the temperature will remain stationary until the whole of the water has frozen, so that the curve will here become a horizontal line or jog *BD*. As soon as all the water has frozen the temperature of the resultant ice will again fall toward that of the surrounding freezing-mixture, and this part of our cooling would give us the part *DE* of our curve.

The reason why the jog occurs is that the freezing of a considerable mass of water occupies a considerable time, and until the whole has frozen the still unfrozen water or "mother-liquor" will still be at its freezing-point, *i. e.*, it will remain at constant temperature. To look at the same thing in another way, in the passage from the liquid to the solid state heat is liberated, and this arrests the fall of temperature.

In the parts *AB* and *DE* of the curve there is no change, chemical or physical, occurring within the water or the ice; hence the smoothness of the curve in these parts.

11. DEFINITION OF MOTHER-LIQUOR AND MOTHER-METAL.—At any given instant during the freezing of a liquid or molten mass, the part which is still liquid or molten, *i. e.*, the part which has not yet frozen, is called the "mother-liquor" in case of aqueous liquids, and "mother-metal" in case of molten metals.

12. OTHER INFLECTIONS IN COOLING CURVES.—Just as the heat evolved in the freezing of the water arrests the fall of temperature, so every change, chemical or physical, which occurs within any cooling mass (be it an aqueous solution, an alloy, or a rock-mass) as it passes any particular temperature or range of temperature, will in general cause either an evolution or an absorption of heat, in short will be accompanied by some thermal action, and this will affect the progress of the cooling and thus will record itself automatically on the cooling curve. For instance the ideal cooling curve of a pure metal is of the same

general family as that of Fig. 7, because the ideal metal undergoes no change in cooling, except that it freezes. If, however, the metal in its cooling should undergo any other change, that change will be recorded in the cooling curve.

A striking case of such changes is afforded by the cooling curve of pure iron. This, as shown in Fig. 12, has no less than ten inflections. The interpretation of these inflections is not always easy. In addition to the jog which occurs as the iron freezes from the molten state, two of these inflections, that of 895° and that just below 766° C., appear to represent allotropic changes in the metal itself, and these inflections are known as Ar_3 and Ar_2 . The latter of these coincides with the recovery of the magnetic properties: *i. e.*, at temperatures above Ar_2 iron is not magnetic, but on cooling past Ar_2 it again becomes magnetic. (See §§ 162, 192, pp. 193, 215.)

13. DISTORTIONS OF COOLING CURVES. — The cooling curves given in Figs. 7 to 11 must be taken as types only. To bring out their features clearly the inflections are exaggerated, and certain irregularities are suppressed. Two causes of irregularity may here be mentioned for illustration.

14. SURFUSION. — It sometimes happens that the freezing of a liquid or molten body, instead of beginning accurately at the true freezing-point of the substance, is deferred through a sort of molecular inertia until the temperature has fallen considerably below this point. This phenomenon is called surfusion. Once freezing sets in, however, the heat which it evolves raises the temperature towards, and more often quite to, the true freezing-point, where it remains during the remainder of the freezing. (Compare § 30, p. 35.)

15. MALOBSERVATION. — The curves here given are supposed to represent the cooling of the mother-mass, the part which freezes last of all, *i. e.*, the part which, at any given moment during freezing, still remains unfrozen; in case of an aqueous solution it is the mother-liquor, in case of a molten alloy it is the mother-metal. But, while these curves are supposed to represent the mother-mass itself, yet they cannot do so accurately towards the end of the freezing, for the reason that we cannot then determine the temperature of the mother-mass accurately. If a mercury thermometer, or any instrument as large as that, were used, it is clear that only part of the bulb could be in the mother-mass

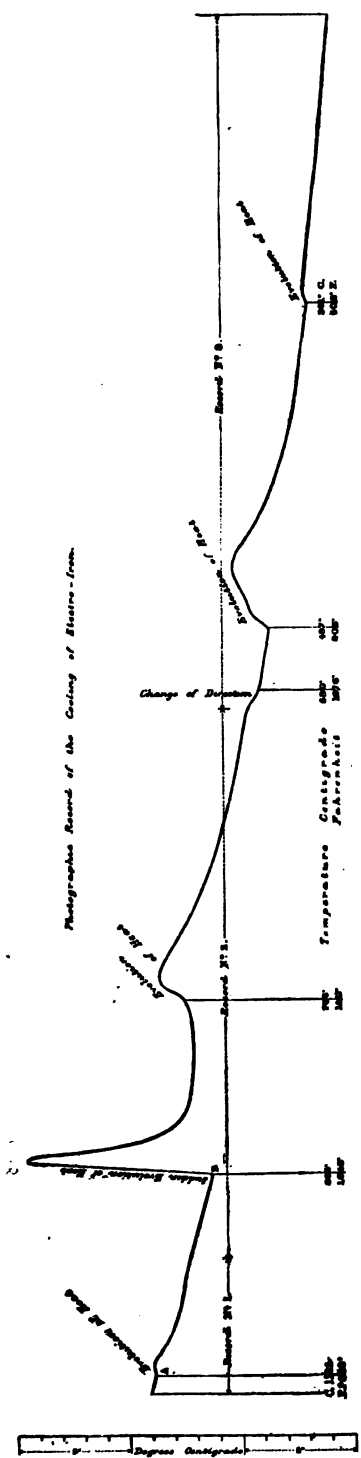

Fig. 12. Differential Cooling Curve of Electrolytic Iron.

(Roberts-Austen, *Fifth Report Alloys Research Committee*, Plate 2, 1899, also *The Metallographist*, II, p. 194.)

Abscissæ are actual temperatures, and ordinates are the differences, at each temperature, between the temperature of the electrolytic iron and a mass of platinum cooling under identical external conditions. This delicate method reveals even slight evolutions and absorptions of heat.

towards the end of the freezing, when the quantity of mother-mass has grown very small.

Much greater accuracy of course can be had by the use of thermo-electric measurement. In this method we determine the temperature of the mother-mass by placing in it a thermo-junction, which consists simply of the ends of two wires of unlike metals, welded or even merely twisted together. These wires extend outside of the mass, and indeed are carried to a convenient distance, and their further ends are twisted together and kept at known temperature, say that of the room. Because of the difference between the temperature of the thermo-junction, *i. e.*, the end which is in the mother-mass, and the cold junction, *i. e.*, the other end at room-temperature, a current of electricity flows through the pair of wires; and this current is a function of this difference of temperature. By measuring this current by means of a delicate galvanometer we determine the difference in temperature between the two ends, and knowing the temperature of the cold junction, by simple addition we get the temperature of the thermo-junction. As the thermo-junction may be made of very fine wires, and as the current is due only to the temperature-difference between the final points of parting of the two wires in the thermo-junction and the cold junction respectively, the indications of the instrument clearly refer only to a very small space in the mother-mass under observation, and not to the whole of that mass, nor even to the relatively large space to which the indication of a mercurial thermometer must necessarily refer, a space necessarily at least as large as the thermometer bulb.

But even with this more delicate mode of measurement, serious causes of malobservation exist. First, while this method will give us the temperature of the mother-mass accurately so long as there is a large quantity of this mass, yet when the freezing is nearly complete and only a small bead of mother-mass still remains unfrozen, the temperature of the couple will be below that of the mother-mass. For the temperature of the already frozen mass will be below that of the still unfrozen mother-mass, not appreciably so to be sure at its very contact with the mother-mass, but decidedly so at its outer layers through which the heat is escaping, and to an intermediate degree in the region between; and the difference in temperature will be the greater the lower is the thermal conductivity of the metal. Now the lead wires of

the thermo-electric couple will conduct heat away from the couple itself towards this outer cooler region, and so tend to depress the temperature of the couple itself below that of the mother-mass in which it is immersed. This effect will be the more pronounced the smaller the quantity of mother-mass remaining.

Again, since the shape of the successively deposited layers is not mathematically concentric, so that the last freezing particles of the mother-mass are not situated in the very centre of the mass, but more or less excentrically, we cannot expect that our couple will, through the last part of the freezing, be in the mother-mass; it is far more likely to find itself in some layer which has frozen an appreciable time before the last of the mother-mass, a layer which consequently is appreciably cooler than the mother-mass. By operating on large masses, and by cooling extremely slowly, we can lessen the error from these sources, but hardly efface it.

To take a single example of the distortion of these curves, the outer corner of the jog, *D*, while theoretically sharp in case of a pure substance as given in Fig. 7, when actually observed is usually more or less rounded as at *D* in Fig. 14, partly because the point at which we determine the temperature is not likely, towards the end of the freezing, to be in the mother-mass or last freezing part. Another probable reason is the escape of dissolved gases during the end of the solidification, so that the mother-mass, even the residual water in case of distilled water, would not in general be pure water, but water containing more or less atmospheric oxygen and nitrogen in solution. The volatilization of this gas in itself absorbs heat and so distorts the cooling curve.

16. EASE OF THERMAL STUDIES. — The cooling curve gives us a very delicate method of detecting all changes which take place within a cooling mass, and of determining accurately the temperature at which they occur. Moreover, the method is not only very delicate but very easy and rapid, much more so than most of our common methods of investigation. For instance, if we are to determine the tensile properties of an alloy, its tensile strength, elastic limit, *etc.*, we must prepare test pieces of considerable size, and these must be throughout their length free from mechanical defects such as blowholes, seams, *etc.* Moreover, the tensile strength which we observe will simply be that of the

section of least resistance of our metal; it gives us no direct indication as to the constitution of the mass as a whole.

So determinations of electric conductivity, dilatation and many other important properties, while they require great care and expense in preparing specimens, yet when applied to a single specimen, throw little light on its constitution. The cooling-curve method, however, not only gives us much light on this question, but can be applied to small and cheaply prepared specimens, and, if carried out with autographic apparatus, is extremely rapid and relatively easy, as well as delicate and accurate.

17. SELECTIVE FREEZING. — The cooling curve in Fig. 8 differs from that in Fig. 7 having a rounded part *BC* between its first part *AB* and its horizontal step or jog *CD*. This is the general shape of the cooling curve of a solution of say 15 per cent of common salt in water, and the rounded part *BC* represents the fact that the salt water in freezing does not freeze to a homogeneous ice as pure water does, but splits up in freezing into crystals of relatively pure water and crystals of relatively pure salt.

In certain cases the salt which thus freezes out is hydrated; but in order to simplify the discussion this fact is left out of consideration throughout this work.

18. DEFINITION OF SELECTIVE FREEZING. — By this I mean that the particles which freeze out of a molten or liquid mass have not, at any given instant, the same composition as the mother-mass out of which they freeze; but that freezing proceeds by selecting from the mother-mass certain elements or compounds either alone, or in greater proportion than that in which they exist in the mother-mass. For instance, in our present case of the freezing of salt water, the fact that what freezes out first is salt ice nearly pure, *i. e.*, having much less salt than the original liquor, is an instance of selective freezing.

Many of us no doubt were surprised on reading Nansen's travels to see that, although he was travelling over a salt ocean and on ice which should have been salt, nevertheless he appears to have very little difficulty in obtaining fresh drinking water. While this is no doubt to be referred in large part to his finding pools of melted snow, yet there is this other cause, that when salt water begins freezing, its freezing is selective. The ice which forms first is relatively free from salt, *i. e.*, the salt which had been dissolved in it is rejected in freezing, and accumulates in the

still unfrozen water beneath, so that a crust of relatively pure ice forms on the top of the salt ocean. When some of the upper layers of this crust remelt under the heat of the sun and again freeze, a second expulsion of salt and purification of the ice occurs, and by this repeated crystallization drinkable water may be had.

In a direct experiment with artificial sea water the author found that, after two freezings, the resultant water was potable, and though saltish to the taste left no after-taste in the mouth: that the outer surface of the ice resulting from the third freezing was quite tasteless, and that the water formed from the melting of this third ice was agreeable, about like Apollinaris water when flat.*

19. OTHER FEATURES OF COOLING CURVES. — Several features of the curve in Fig. 8 demand attention. First, the point *B* at which freezing begins is not at the normal freezing-point of water, 0° C., but at -11° . We say that the dissolved salt lowers the freezing-point, and, within limits, the more salt a solution contains the lower is its freezing-point.

So when plumbiferous tin (Fig. 28 F, p. 60) is cooled, the freezing of the tin does not begin until the temperature has fallen considerably below the freezing-point of pure tin. In other words, although the freezing-point of pure lead (326°) is higher than that of pure tin (231°), yet by the presence of this lead the tin is

* The numerical results were as follows:		TASTE
	SP. GR.	
(1) Original liquor, artificial seawater	1.0205	
(2) 1st ice, crust formed on partly freezing No. 1.		
(3) 1st remelted liquor, resulting from completely remelting No. 2,	1.0150	
(4) 2nd ice crust, formed on partly freezing No. 3.		
(5) 2nd remelted liquor resulting from wholly remelting No. 4	1.0060	potable, taste saltish, but no taste remains in mouth.
(6) 3rd ice crust formed on partly freezing No. 5.		upper part tasteless.
(7) 3rd remelted liquor, resulting from wholly melting No. 6,	1.0031	agreeable, about like Apollinaris when flat.

held molten at a temperature even below its own freezing-point of 231° .

20. FREEZING COVERS A CONSIDERABLE RANGE. — Next the freezing of our 15 per cent salt solution, instead of occurring at a fixed temperature, covers a considerable range, that from *B* to *C*. But this is clearly a consequence of what was described in § 18, p. 24. For as the water which first freezes in our flask to relatively pure ice, thereby rejects the salt which it had contained; and as this salt thereby concentrates progressively in the central region of still unfrozen water or "mother-liquor"; and finally as this consequently grows progressively richer in salt, it thereby acquires a progressively lower and lower freezing-point; or in other words as the enrichment of the mother-liquor in salt goes on, a lower and lower temperature is needed to induce the further freezing out even of relatively pure ice. Hence the considerable range of temperature covered by freezing: while that the curve is rounded, instead of being a straight line, represents the fact that this fall of the freezing-point is not strictly proportional to the time which it occupies, but becomes more and more rapid as the freezing progresses.

21. SELECTION NATURALLY TO BE EXPECTED. — Considering next the fact that the freezing of a salt-water solution is selective, let us ask whether this is what should naturally be expected; and to this end let us try to picture to ourselves what actually occurs in the freezing of a 15 per cent salt solution. These mental pictures, even if not strictly accurate, may be of great value in enabling us to frame the various facts into a consistent harmonious whole, instead of regarding them as simply arbitrary facts to be learned by rote, and quickly forgotten.

First let us conceive for an instant that the opposite is true, *i. e.*, that freezing is unselective, and see whether, in such a case as that of salt water, containing 15 per cent of salt, of a solvent and a solute which for simplicity we may assume form no chemical compound with each other, the conception is natural, or whether it is more natural to expect the freezing to be selective. To fix our ideas, let us suppose that a single most minute quantity of the liquor were to freeze unselectively, yielding a minute particle of salt ice of the same composition as the mother-liquor, 85 per cent of water and ice and 15 of salt. For simplicity let us assume that solid salt and solid ice are absolutely insoluble in each other.

(See § 51, p. 63.) On account of this reciprocal insolubility, what has first frozen must really be two distinct flakelets, one of pure ice and one of pure salt; and these two flakelets find themselves in contact with the liquid mother-liquor.

Reflection shows that our flakelet of salt ought to redissolve. First, while a 15 per cent salt solution cannot remain liquid at the existing temperature (which by assumption is at the freezing-point of such a mixture) a solution containing more than 15 per cent can, because as we have just seen any increase of salt in this range lowers the freezing-point. Hence if our salt flakelet were to redissolve and reënter the mother-liquor, the solution or new mother-liquor which its reëntry would form, would be fusible, *i. e.*, would remain liquid, at the existing temperature. But this is the general condition which determines whether a substance shall unite with and dissolve in any liquid to which it is exposed, *viz.*, that the product of their union is fusible, *i. e.*, can remain liquid, at the existing temperature. The salt flakelet should redissolve in the mother-liquor, simply because by doing so it would yield a mother-liquor fusible, *i. e.*, liquid, at the existing temperature.

But the flakelet of ice, *i. e.*, of frozen pure water, does not redissolve, simply because its reëntry into the mother-liquor would restore the 85:15 ratio, would make the mother-liquor infusible, *i. e.*, incapable of remaining liquid, at the existing temperature.

Hence in effect at this stage a single flakelet of pure ice has frozen out, because our salt which we conceived to have frozen would naturally redissolve. The freezing has thus far been rigidly selective. Clearly what has been true of the first flakelet should be true of succeeding ones.

Thus we see that selective freezing, instead of being a surprising phenomenon, is what we ought to expect; for, when we try to picture to ourselves unselective freezing we see that it ought to change itself spontaneously to selective freezing.

Attention is particularly directed to this reasoning, that whether a flake, assumed for argument to have frozen, will redissolve or remain frozen, should depend primarily on whether its remelting would or would not make the mother-mass fusible at the existing temperature; for from this point of view we readily see most simple explanations of several of our most important and indeed at first sight surprising phenomena.

22. SELECTIVE AND UNSELECTIVE FREEZING. — We have seen that freezing may be either of two types,

(1) the selective or concentrating type, like that of salt water, yielding an inclined or rounded freezing region in the cooling curve. In this type the substance which first freezes has not the exact composition of the molten or liquid mass from which it freezes, so that some component of that mass progressively concentrates in the still unfrozen mother-part, with consequent progressive change of the freezing-point of that mother-part, so that freezing covers a considerable range of temperature.

(2) The unselective type, in which the liquid or molten mass freezes without such selection or change. Here, because the composition of the part unfrozen remains constant throughout freezing, its freezing-point remains constant, and is represented by a horizontal jog theoretically with sharp corners, like *BD* in Fig. 7. (See § 15, p. 20.)

We have each of these types in the freezing of molten alloys as well as in that of aqueous solutions.

Of the selective type we have two classes,

(A), those yielding a homogeneous mass, as when that which freezes out is (1) a pure and definite substance (this has been for simplicity assumed to be true of the salt which freezes out of our salt water), or (2) a single metal wholly free from those with which it was united when molten, or (3) a definite chemical compound of two or more metals, or (4) *conceivably*, a solid solution, the successively deposited layers of which are of the same composition, *i. e.*, a homogeneous solid solution. As we shall see, the successive layers of a solid solution as they successively deposit, are not normally of like composition, *i. e.*, are not homogeneous in the act of solidifying, though diffusion tends to remove their initial heterogeneousness (§§ 54, 55, 60, and 114; pp. 65, 66, 68 and 135).

(B), those yielding a heterogeneous mass, as when that which freezes out is a heterogeneous solid solution.

23. THE JOG AND THE EUTECTIC. — In the cooling curve of salt water (Fig. 8, p. 18), besides the rounded part which we have been considering, there is a sharp-cornered horizontal jog *CD*. What is the meaning of this?

As already explained, as the freezing of the salt water progresses more and more ice freezes out, and the remaining still

liquid mother-liquor becomes progressively richer and richer in salt; and this goes on until, when the temperature has fallen to -22° C., the proportion of salt in the mother-liquor reaches 23.6 per cent, the "eutectic ratio," a term which will be explained shortly. But beyond this concentration in general it refuses to go, for a simple reason which we shall soon see. The progressive freezing of pure ice and the consequent enrichment of the mother-liquor in salt now cease, and, on further cooling, the mother-liquor gradually freezes without selection, *i. e.*, the ice which now forms has the same composition as the mother-liquor from which it forms, so that now the composition of both the nascent ice and the mother-liquor remains constant, and further so that the freezing-point of the mother-liquor therefore remains constant. Hence, finally, the horizontal jog *CD*. (See § 10, p. 17.)

But though the freezing of the mother-liquor from this point on is unselective, so that that which freezes out has the exact composition of the mother-liquor, this freezing is of special sort, in that the mother-liquor in freezing splits up into a conglomerate mass of distinct crystals of ice and distinct crystals of salt, interstratified in thin plates. But, as has just been said, this conglomerate which freezes during this period is uniform throughout; and the plates of salt form 23.6 per cent of it, and the plates of ice 76.4 of it; *i. e.*, the ratio of plates of the frozen water to those of frozen salt is throughout the eutectic the same as the ratio of liquid water to dissolved salt in the mother-liquor at the time when its further concentration was arrested, and when it froze unselectively to form this conglomerate eutectic.

24. FREEZING OF A 20 PER CENT SALT SOLUTION. — If, now, instead of starting with a solution of 15 per cent of salt we started with one of 20 per cent of salt (Fig. 9, p. 18), we should get a curve of the same family. The rounded part would begin at a lower temperature because, owing to the initial greater richness in salt, the freezing-point is lower, *i. e.*, a lower temperature is required to induce the first freezing out of ice. The rounded part would end at the same temperature as in the preceding case, because, no matter what the initial concentration of the salt is, the percentage of salt in the mother-liquor will reach this same eutectic ratio of 23.6 per cent at one and the same temperature, *viz.*, -22° C. But the jog will be longer in case of a 20 per cent than in the case of a 15 per cent solution of salt, simply because

in the former the quantity of mother-liquor remaining when the concentration has reached 23.6 per cent, will evidently be greater, and the time occupied in freezing it will be correspondingly greater.

Conversely, since the quantity of relatively saltless ice which will form before the mother-liquor has reached the eutectic ratio of 23.6 per cent will be less than in the 15 per cent solution case, not only will the length of the part *BC* be less, but the retardation caused by the freezing out of this relatively saltless ice will be correspondingly less, and hence the inflection which it causes between *B* and *C* will be less. Thus comparing the portion *BC* in Fig. 8 with that in Fig. 9 we note that the former is much more sharply inflected than the latter.

In short, dividing the freezing into two parts, the ice-freezing and the eutectic-freezing periods, *BC* and *CD*, as the proportion of salt approaches the eutectic ratio the lower will be the beginning of the ice-freezing part, and the shorter and less sharply inflected will it be; while the longer will the eutectic-freezing part *CD* be.

25. FREEZING OF A EUTECTIC SOLUTION. — If now, as in Fig. 10, the liquor initially contained exactly the eutectic proportion, 23.6 per cent of salt, then, as we progressively cool it, no freezing will take place until the temperature of -22° has been reached, when the whole will freeze unselectively, as a pure metal or pure water would, but splitting up as before into parallel plates of ice and of pure salt.

26. FREEZING OF A HYPER-EUTECTIC SOLUTION. — If, finally, instead of 23.6 per cent of salt there is 26 per cent of salt initially present, then our curve will be of the shape shown in Fig. 11, which is of the same family as those in Figs. 8 and 9. The freezing which is represented by the rounded part *BC* will, however, not be of water but of salt,* because the initial solution

* Or of a hydrate richer in salt than the eutectic. Guthrie, *Phil. Mag.*, 5th Ser., I, 1876, p. 355.

The precipitation of the excess of salt in this case is exactly that which occurs when any hot saturated solution, for instance that of cupric sulphate, is gradually cooled. And here we may note that the freezing and crystallizing of ice, the precipitation or crystallizing of a salt from a solution which through cooling becomes super-saturated, and the freezing of a metal, are really one and the same thing; they are a passage from the fluid to the solid state. Water in freezing looks different from salt precipitating out, and both of these occur at a temperature so very much lower

as a whole contains an excess of salt over the 23.6 per cent or eutectic ratio.

27. EUTECTIC AND CRYOHYDRATE. — Returning to our salt water solution, the fact that, no matter what the initial concentration of the solution is, the jog caused by the freezing of the eutectic occurs at the same temperature, and the mother-liquor which there freezes has the constant composition of 23.6 per cent of salt, shows that this percentage composition has some particular and important relation. This ratio of salt to water is the "eutectic" or "cryohydrate" ratio, the ratio which gives the lowest freezing-point, *i. e.*, the greatest fusibility. In case of aqueous liquids it is usually called the "cryohydrate"; in case of alloys it is called the "eutectic," which translated literally means the "well melting" alloy. Guthrie defined the eutectic in accordance with this meaning as the most fusible alloy. But as the cryohydrate and the eutectic are essentially one and the same thing, we may for our present purpose apply the name "eutectic" to both.

28. PROPERTIES OF THE EUTECTIC. — To recapitulate, the striking properties of the eutectic are:

(1) that its composition and hence its freezing-point are constant, no matter what the initial ratio between the solvent and the solute, *i. e.*, the composition of the solution or alloy,*

(2) that its composition is not, save occasionally and as it were by accident, in simple atomic proportions,†

than that at which metals commonly solidify, the circumstances are so different, that we usually do not appreciate that they are really one and the same thing. But this conception of the essential identity of the solidification of a metal, the freezing of water, and the precipitation of a salt is very important for the student of alloys.

* As will be explained in §§ 126 and 127, pp. 148 and 149, in case of the alloys of gold with aluminium, of antimony with copper, in short of alloys of those metals which form definite chemical compounds with each other, the eutectic which forms when one of those metals is in great excess, may differ from that formed when the other metal is in great excess. In other words, such a series of alloys may have one eutectic at one of its ends and another at the other end, and still others at different ranges; but each eutectic is of constant composition.

† Guthrie pointed out that "The statement therefore that alloys of minimum melting-points are got on mixing the metals in certain simple ratios of their atomic weights, is presumably to be put on one side." ("On Eutexia," *Phil. Mag.*, 5th Ser., XVII, 1884, p. 465.)

(3) that it consists of a conglomerate of distinct particles of the two components, mechanically mixed.

If the two components of the eutectic are soluble in each other (when solid) in all proportions, the eutectic is not a conglomerate but simply a solid solution. If the two components are soluble in each other but only to a limited degree, then the eutectic is a conglomerate of particles of the two components, the particles of each component being saturated with the other. In short, it is a conglomerate of saturated solid solutions of the two components. But

EUTECTIC STRUCTURE

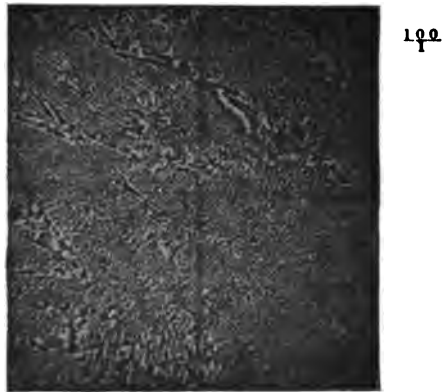

Fig. 13. Alloy of 58 per cent Bismuth, 42 per cent Tin.
Made by Wm. Campbell in the Author's Laboratory.

these facts we may for the moment leave out of sight. We will take them up and consider their explanations in §§ 57, 65 and 68; pp. 62, 73 and 74.

The most characteristic, and perhaps the most usual mode of occurrence is in alternate plates of each of the two components, interstratified, and not crossing each other. (Fig. 13.) But in a very considerable proportion of cases the two components of the eutectic, though clearly distinct from each other, have a cellular or spherulitic instead of a sheet-like structure. Fig. 17, p. 47, shows the banded or sheet-like and spherulitic structure of the eutectic occurring side by side in the same specimen.

The two components may, as in the case of alloys of lead and tin, be plates of one metal interstratified with plates of another metal; or as in the case of salt and water each may be a definite chemical compound, plates of ice being interstratified with those of sodium chloride; and the same may occur in the case of alloys. For instance in the case of alloys of copper and antimony (Fig. 51, p. 150) we have a eutectic which consists of layers of copper interstratified with layers of antimonide of copper. Again the quasi-eutectic or æolic (See § 148, p. 178) which forms in steel consists of plates of the definite carbide, cementite, Fe_3C , interstratified with plates of pure iron or ferrite (Fig. 63, p. 177). That which forms in oxide-bearing copper appears to consist of plates of cuprous oxide interstratified with plates of copper;* that in phosphoric iron appears to consist of plates of a definite iron phosphide Fe_3P interstratified with a saturated solution of that same phosphide in iron, *etc.*, *etc.*†

The alloys of three or of four metals may contain eutectics consisting of interstratified plates of the three or the four component metals.‡

29. REASONS FOR THE PROPERTIES OF THE EUTECTIC. —

There are extremely simple reasons why the eutectic formed in the freezing of salt water should have the properties which have just been enumerated, surprising as those properties at first seem. These reasons are readily seen on following the freezing of a solution of say 15 per cent of salt in 85 of water. To this end let us again follow the progress of freezing. It begins with the freezing out of a little pure ice; this enriches the residual mother-liquor in salt; and this in turn lowers the freezing-point of that mother-liquor, *i. e.*, the temperature to which we must cool it to induce further freezing of ice; and this joint freezing out of ice and lowering of the freezing-point go on progressively through the ice-freezing period, a residue of mother-liquor persisting unfrozen, because as fast as the temperature falls, so fast does the freezing-point of the mother-liquor fall thanks to its simultaneous enrich-

* Heyn, *Bulletin Société d'Encouragement pour l'Industrie Nationale*, CI, p. 276, 1901.

† Stead, *Journ. Iron and Steel Inst.*, II, 1900, p. 83.

‡ Guthrie, *Phil. Mag.*, 5th Ser., XVII, pp. 465-6; Charpy, *Bull. Soc. d'Encouragement*, 5th Ser., III, pp. 690-1, 1898; *The Metallographist*, II, p. 32, 1899.

ment in salt, so that at each instant the mother-liquor is at its freezing-point.

But there must be an end to this: there must be a limiting temperature at which no mixture of salt and water can (normally) remain liquid, and that limiting temperature is the freezing-point of the most fusible, *i. e.*, the most easily liquefiable mixture of salt and water, *viz.*, that with 23.6 per cent of salt, freezing at -22° C. On reaching this temperature and composition the mother-liquor itself should freeze. For, just as it was the progressive enrichment of the mother-liquor in salt that caused it to remain unfrozen in spite of the progressive cooling, simply because that enrichment gave to the mother-liquor a lower freezing-point; so when the enrichment in salt reaches and tends to pass 23.6 per cent it should fail to keep the mother-liquor from freezing, because further enrichment in salt, instead of lowering, would raise the freezing-point; instead of keeping the mother-metal from freezing it would make it freeze all the sooner. At every instant in the cooling until this 23.6 per cent is reached, the mother-liquor is at its then freezing-point, and is kept from actually freezing by the simultaneous fall in that freezing-point caused by the freezing out of water and consequent enrichment of the mother-liquor in salt. The mother-liquor at each instant is on the point of freezing, but in starting to freeze renders itself unfreezable at the existing temperature by thus as it were ejecting from itself a little water and so making itself richer in salt. But when it has reached 23.6 per cent of salt and simultaneously reached the freezing-point of that mixture, freezing cannot normally be deferred by further differentiation, because any change in composition would now raise the freezing-point; as the mother-liquor is now at its freezing-point, to raise its freezing-point without raising its temperature would freeze it. Hence, further selection offers no escape from freezing.

Hence we see why the composition and freezing-point of the eutectic are constant and independent of the initial proportions of salt and water. For, no matter what those proportions, since the condition which enables the mother-liquor to remain unfrozen through progressive cooling is that the change in its composition (which, through the freezing out of one component, accompanies that cooling), leads to a lower freezing-point; so this permissive condition ceases when the 23.6 per cent limit is reached simul-

taneously with the freezing-point for that limit, simply because no further change in composition can now yield a lower freezing-point, *i. e.*, no possible combination of salt and water can normally remain liquid at this temperature, a condition of affairs evidently wholly independent of the initial composition. Of course, the nearer the initial composition of the liquor is to this 23.6 ratio, the less will be the excess of water (or salt) to be frozen out before

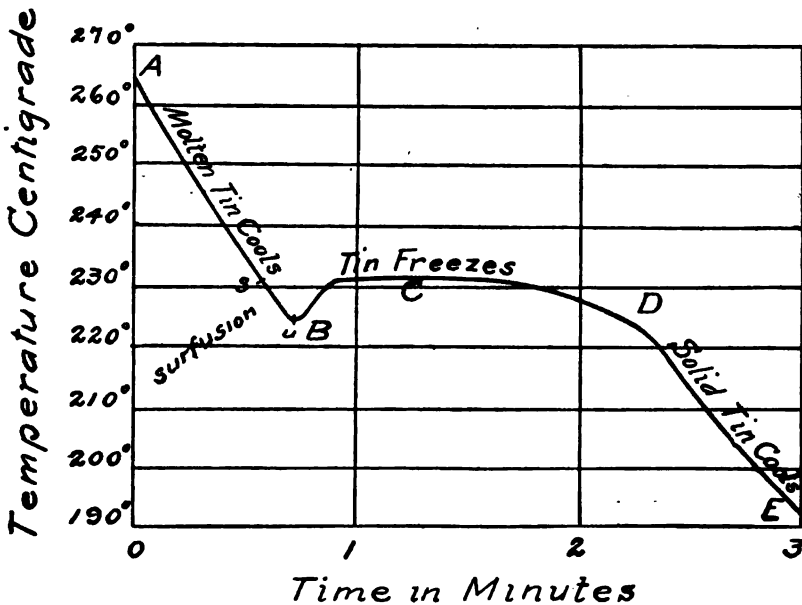

Fig. 14. Cooling Curve of Tin.

(Roberts-Austen, *Third Report Alloys Research Committee*, Fig. 7, Plate 39.)

The wording on this figure is the author's, not Professor Roberts-Austen's.

reaching this ratio, and the larger will be the quantity of the eutectic which will form; but the composition and freezing-point of the eutectic are clearly wholly independent of this.

30. SURFUSION. — These assertions represent the condition of equilibrium, the normal condition towards which our phenomena tend. But though our phenomena tend towards equilibrium they are often prevented from reaching it, for instance through surfusion, a matter which we will now consider.

It has long been known that water and other liquids, if kept perfectly still, may be cooled considerably below their true or normal freezing-point without actually freezing; but that if then agitated they at once freeze, and so rapidly that the latent heat of solidification raises the liquid quickly to its true freezing-point, 0° C. in case of water.

The same is true of molten metals. Thus, Fig. 14, p. 35, shows the cooling curve of molten tin, which passed about 5° below its normal freezing-point (231° C.) before it began freezing. The temperature then rose quickly to about 231° , and remained nearly stationary till the whole had frozen. This phenomenon of remaining molten below the true freezing-point is known as surfusion.

So in the familiar example of a solution of sodium sulphate. A solution of this substance saturated at its boiling-point can be cooled to the temperature of the room without crystallizing, although it thereby becomes very greatly supersaturated; *i. e.*, the water retains in solution very much more sodium sulphate than it is capable of absorbing at the room-temperature, and very much more than normally corresponds to its saturation-point at this temperature. But if a crystal of sodium sulphate is dipped into this supersaturated solution, the whole crystallizes, *i. e.*, solidifies or freezes very rapidly, the solidification or freezing radiating out from this crystal as a nucleus. The same effect is brought about by dipping a glass rod into the supersaturated solution; but if the rod is freed from dust, or heated and then cooled, it may not induce freezing.

In determining the freezing-point of alloys, surfusion may depress both freezing-points, *i. e.*, the temperature at which the excess-metal begins freezing, and that at which the eutectic begins freezing. The cooling curve in Fig. 15 shows an apparent case of surfusion of the eutectic in a tin-copper alloy,* containing about 96 per cent of tin and 4 per cent of copper. Had the freezing been normal, *i. e.*, had there been no surfusion, the eutectic should have begun to freeze when the temperature reached C, and the cooling curve should have been something like *ABCKDE*. The part *CK* has been dotted in here to show this normal course of freezing. But actually the freezing of the eutectic appears not

* *Third Rept. Alloys Research Committee*, Plate 41. The wording on this figure is the author's, not Professor Stansfield's.

to have begun until the temperature fell to *J*. The heat liberated by its freezing then raised the temperature of the whole to *K*, and the rest of the eutectic froze at constant temperature, *KD*.

Another case of surfusion of a eutectiferous alloy is given in § 43, p. 54.

A means of preventing surfusion, like that used in the case of the supersaturation of sodium sulphate, is to drop a little solid alloy into the molten one, to act as a nucleus to start freezing. Agitation of the molten mass also arrests surfusion.

We are here reminded of the fact that water* can be raised far above its true boiling-point of 100°C ., even to 180° , without actu-

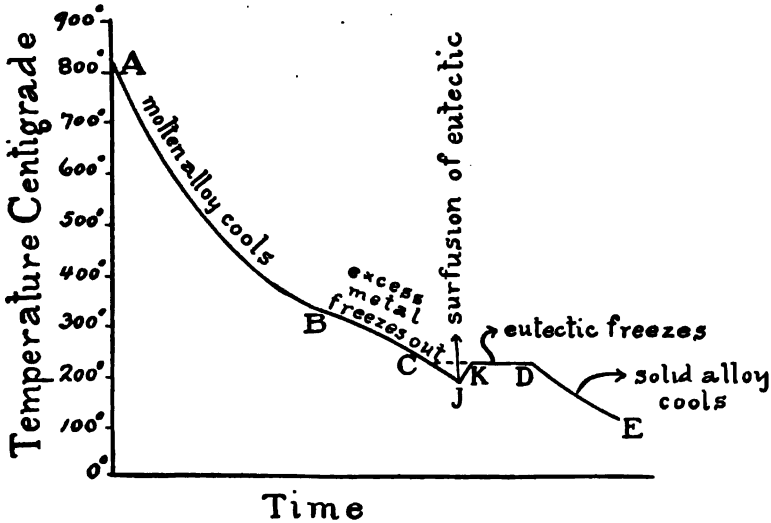

Fig. 15. Surfusions of a Eutectic in a Tin-copper Alloy Cooling Curve:

Tin 96 per cent, Copper 4 per cent.

(A. Stansfield, *Third Rept. Alloys Research Committee*, Appendix 2, Plate 41.)

ally boiling. If, however, a nucleus to start boiling is provided, *e. g.*, if bubbles of appreciable size of any gas once form within it, or are passed through it, boiling takes place rapidly or even violently. It is familiar that the bumping of solutions can often be prevented by offering a rough surface to induce boiling. These effects can be referred to surface-tension. The water evaporates within itself readily if there are bubbles into which it can evap-

* At atmospheric pressure.

orate. The smaller the bubble the greater the resistance does its surface-tension offer to boiling, *i. e.*, to the entry of gas into it by evaporation from its sides. An infinitely small bubble, *i. e.*, a liquid free from bubbles, offers an infinite resistance to boiling. If the water initially contains dissolved air, or any other substance more volatile than itself, this volatilizes and creates bubbles into which steam can evaporate; hence the bumping tendency of liquids which, by long boiling, have been freed from volatile foreign matter.*

Thus, though there are definite temperatures which are the normal upper and lower bounds of the liquid state, within which bounds alone that state is normal, yet a liquid may be induced to retain its liquidity both above and below this range, may pass the upper bound without boiling and the lower one without freezing, in each case remaining in a state of unstable molecular equilibrium, liable to be upset by mechanical means, by inducing a nucleus from which freezing or boiling may start. Once this equilibrium is upset, the boiling or freezing, the change of state, goes on very rapidly, even violently, and the substance passes into the molecular state normal for the existing temperature.

The important point for us to recognize here is that surfusion may distort the cooling curves, so that those which have been sketched in this work are to be taken as types, in which this disturbing influence is for simplicity ignored. So in the explanations offered in this work of selective freezing, of the properties of the eutectic, *etc.*, the disturbing influence of surfusion is ignored.

31. WHY THE EUTECTIC IS COMPOSITE. — That the eutectic formed on freezing salt-water solutions consists of alternate plates of salt and of ice simply represents the assumed fact that solid ice and solid salt are insoluble in each other, soluble as salt is in liquid water. (For brevity I purposely assume here that this insolubility is complete. See § 51, p. 63.)

That though liquid water dissolves salt, salt and solid water, *i. e.*, ice, are insoluble in each other, necessarily implies that when the eutectic freezes they must (normally) cease to remain dissolved in each other, *i. e.*, they must mutually expel each other,

* Compare "Theory of Heat," J. Clerk Maxwell, D. Appleton & Co., 1875, p. 289.

so that each isolates itself from the other. Hence their existence as distinct particles. That these distinct particles should in general have a sheet form would not, however, be so easily foreseen. Indeed, as we have seen (§ 28, p. 32) this form is by no means universal.

32. WHY THE EUTECTIC IS NOT OF SIMPLE ATOMIC PROPORTIONS. — That the composition of the eutectic is not in simple atomic proportions is natural enough. Its composition is that of the solution (or molten alloy) of lowest freezing-point; and we see no reason why this lowest freezing-point should correspond to any simple atomic ratio. It is the freezing-point of a homogeneous liquid solution which we are considering, rather than the melting-point of a solid, which we know to be a conglomerate mass. The very indefiniteness and indeterminateness of composition of solutions, and their freedom from marked critical points, seem opposed to the idea that their lowest freezing-point, or indeed their maxima and minima in general, should correspond to simple atomic proportions.

33. ARRIVAL AT EUTECTIC COMPOSITION AND FREEZING-POINT ARE SIMULTANEOUS. — That the arrival at the eutectic composition and freezing-point must be simultaneous is simply a single instance of the general condition which we have traced during freezing; for we have seen (§ 29, p. 33) that at every instant during freezing the mother-metal is beginning to freeze, *i. e.*, is at its then freezing-point. That its freezing is not completed at that temperature is simply because the selective change of composition which accompanies the progress of freezing is to and through a series of compositions each corresponding to a lower freezing-point than the preceding.

34. EUTECTIC PLUS EXCESS. — Now, looking at Figs. 8 to 11 collectively we may note that whatever be the initial percentage of salt in our salt-water solution, when it is frozen it will contain a eutectic of 23.6 per cent of salt. If there is initially present say 30 per cent of salt, or an excess of 6.4 per cent over this eutectic ratio of 23.6 per cent, then the mass when frozen will be a conglomerate consisting in the first place of the eutectic in its interstratified layers, and in the second place of this 6.4 per cent of salt in separate crystals, mechanically intermixed with the eutectic. If on the other hand there is say 15 per cent of salt initially present, so that there is 8.6 per cent excess of

water over the eutectic ratio, then the mass in freezing as a whole will form a conglomerate consisting of the eutectic as before, plus this 8.6 per cent excess of mechanically intermixed crystals of ice. In short, the frozen mass will in every case be a conglomerate, consisting of a *eutectic plus an excess-substance*, which will be either salt or ice, as the case may be. In the liquid state, if water is in excess over the eutectic ratio we say that we have salt dissolved in water; if salt is in excess we may say that we have water dissolved in salt. The excess-substance of the solid state is the solvent in the liquid state, in this view.

34 A. PRECAUTION AS TO THE TERM "EXCESS-SUBSTANCE." —The student should here recognize clearly that the term "excess-substance" refers strictly to excess over the eutectic ratio, and does not at all refer to excess in absolute quantity. For instance in a salt water solution containing 30 per cent of salt and 70 per cent of water, the salt is the excess-substance simply because there is more salt than corresponds to the eutectic ratio of 23.6 per cent; and it is in this sense the excess-substance in spite of the fact that the absolute quantity of salt is less than half that of the water present. In some other cases the excess-substance may bear a still smaller ratio to the other or deficit-substance.

This fact that the excess-substance may be very much less in absolute quantity than the deficit-substance is certainly an objection to the term itself, because it may easily lead to confusion. On this account the expression "hyper-eutectic substance" has the great advantage of carrying its meaning, excess over the eutectic ratio, more clearly on its face. But the brevity and convenience of the expression "excess-substance" are so great that it will be used in this work, though not without some misgivings.

It is as if, assuming that a company of infantry should normally consist of one captain and one hundred privates, we were to find that in some individual company there happened to be ten captains and only ninety privates. We should here with perfect propriety say that there was an excess of captains, and every one would properly understand that we meant, not that there were absolutely more captains than privates, but that the captains were in excess over the normal ratio of 1 : 100.

35. THE EXCESS-FREEZING AND THE EUTECTIC-FREEZING PERIODS. — From what has just been said, the division made at the

end of § 24, p. 30 into the ice-freezing and the eutectic-freezing periods, should be replaced by the more generic one of (1) the excess-freezing and (2) the eutectic-freezing periods (*BC* and *CD* in all the cooling curves in this work), a division which, as we shall see, applies to the freezing of our eutectiferous alloys, which are very numerous. (§§ 47 to 52, pp. 59 to 64.)

35A. REASONS FOR THE SPHERULITIC STRUCTURE OF CERTAIN EUTECTICS. — My own observations lead me to believe that the banded sheet-like structure, with its zebra-like markings, is the normal structure, the structure with which the eutectic habitually comes into existence; and that the spherulitic structure is due to the drawing together or coalescing of the initially distinct particles of one of the two constituents of the eutectic. Indeed, the separate particles of each constituent may coalesce into larger but still distinct masses. Thus I found that in an alloy of 96.74 per cent copper with 3.30 per cent of silver by weight, when cooled very slowly, the eutectic at first sight seemed to be entirely lacking. There were little white lakes of silver in the great ground mass of copper; and towards the middle of these lakes were a very few small islands of copper. This was exactly what I had expected, although under the usual conditions of slow cooling this alloy contains a little distinct eutectic, together with much argentiferous copper.

The explanation is extremely simple. The eutectic itself doubtless consisted initially of sheetlets of argentiferous copper and other distinct sheetlets of cupriferous silver. But during the prolonged stay at a temperature very slightly below the freezing-point, the copper particles of the eutectic slowly migrated outwards, so as to coalesce with the continent of copper surrounding the pool of eutectic, and at the same time the silver particles coalesced so as to form a lake instead of a banded mass. The little islands of copper remaining were simply those which had not yet coalesced with the outer continent.

Again, on heating an alloy of 62.98 per cent silver and 37.00 per cent copper for seven hours to a temperature but slightly below the eutectic freezing-point, I obtained similar results. This alloy should normally consist of (1) copper as the excess-metal and (2) the eutectic, and under common conditions we should have large islands of copper in what we might call a marsh of eutectic. But in this alloy I found that the eutectic marsh in the neighbor-

hood of the islands of copper had converted itself into a free littoral region, *i. e.*, around the islands of copper there was a free littoral region of silver containing no bands of copper, from which I infer that the bands of copper initially present in this littoral region had coalesced with the islands of copper.

Further, the eutectic proper, while still distinctly recognizable, had lost to a great degree its banded structure, and the sheets of copper were in large part replaced by minute circular islands of copper, arranged in rows.

This coalescing and outward travel is like that of the bubbles floating on the surface of water in a tumbler. The bubbles initially near the edge of the tumbler quickly move outwards and attach themselves to the walls of the tumbler. Those initially nearer the centre, with less attraction towards the walls, and with the attraction of one wall partly offset by that of the opposite, move very slowly; but, given time enough, all will reach the sides of the tumbler.

In quite the same way, it seems to me, we can explain the spherulitic structure of certain eutectics. There has been, at a temperature high enough to give much mobility, a sojourn so long that the sheets of one component have drawn together into little spheres, like so much oil in water.

It has sometimes been said that in a eutectiferous alloy "structurally free" particles of the two constituents of the eutectic cannot coexist. This is wholly incorrect. It is true that there cannot be at the same time an excess of both constituents over the eutectic ratio. If, for instance, silver is in excess over the eutectic ratio, copper cannot simultaneously be in excess. But there is no reason why the particles of the eutectic should not so coalesce, each constituent by itself, that each forms masses of considerable size which, to the eye, are structurally free. Let us recognize that structural freedom may be an accident; as in the case described above, the metal in deficit may form structurally free masses. Hence, for precise thought, the expressions "excess-metal" and "deficit-metal" may be found better than "structurally free metal."

If I am right in this, then the banded structure of the eutectic may be looked upon simply as an accident, and we have to fall back upon its quality of being an alloy of lowest melting-point, and also that it is composed of distinct constituents, as its two

essential qualities. Of these the former evidently is the sole distinguishing quality.

35B. INFLUENCE OF THE STRUCTURE OF THE EUTECTIC. — I have often been puzzled by the very great degree of ductility which I have given to certain steels by extremely slow cooling. Now this change in the structure of the eutectic is certainly a possible cause, and one which should be investigated. Steel, as we shall see, is a eutectiferous alloy, and the two constituents of its quasi eutectic are sheets of glass-hard brittle cementite, Fe_3C , and other sheets of soft copper-like ferrite or free iron. It may well be that the prolonged sojourn at a high temperature which extreme slow cooling implies, may enable the sheets of cementite to depart somewhat from their initial sheet form and to change towards the spherical form. Further, it is but reasonable to suppose that rounded spheres of cementite should interfere less with the ductility of the whole mass than the same quantity of cementite in the form of sharp-edged sheets; and that even a fractional change from the sheet-like towards the spherical form should have an effect like in kind, though less in degree.

36. MANY ALLOYS PARALLEL WITH THE SALT-WATER SERIES. — Many of our alloys, for instance those of lead with tin, form a series similar to the salt-water series which we have been considering. Like it, lead and tin form a eutectic, a conglomerate of plates of lead interstratified with plates of tin. Its composition though not in atomic proportions is constant, *viz.*, lead 31 per cent, tin 69 per cent; hence its freezing-point is constant. Any given solid lead-tin alloy consists of the eutectic either alone or with an excess of lead or of tin, according to whether the alloy as a whole contains just 31 per cent of lead and 69 of tin, or an excess of lead or of tin over this ratio. The cooling curves of pure lead, pure tin, and of the 31-69 per cent alloy (Figs. 28 A, 28 G, and 28 E, p. 60) are comparable with those of pure water, pure salt, and the 23.6 per cent or eutectic salt solution (Figs. 7 and 10, p. 18), unselective, with their smoothness interrupted only by the jog (*BD* or *CD*). The cooling curves of the alloys which contain an excess of lead or of tin (say lead 67, tin 33 per cent, Fig. 28 C, and tin 85, lead 15 per cent, Fig. 28 F) are like those of salt water containing an excess of water or of salt above the eutectic ratio (Figs. 8, 9 and 11), with their selective or excess-freezing period *BC*, *i. e.*, the progressive freezing out of the excess-metal

and consequent enrichment of the still molten mother-metal in the deficit or dissolved metal (tin if lead is in excess, and lead if tin is in excess), beginning at a temperature below the freezing-point of the excess-metal (a temperature which is the lower the nearer the composition of the alloy as a whole is to the eutectic ratio), continuing through a considerable range of temperature with the rounded curve *BC*, and ending with the freezing of the eutectic at a constant temperature of 180° , represented by the jog *CD*.

37. STRATIFICATION ACCORDING TO DENSITY. — The fact that, in a partly frozen pond, the ice, the lighter substance, floats at the top and the water, the heavier, is beneath it, might well suggest to us that in frozen alloys we should find the different constituents stratified according to density. Indeed the general conditions might well suggest this. In fact such stratification is rarely marked, except in case of alloys which while molten break up into different parts which refuse to coalesce with each other. In this case, indeed, the stratification may be very decided. But in case of alloys which are homogeneous while molten but in freezing split up into different constituents, such as the eutectic and the excess-metal, we should hardly expect that stratification would be marked.

In the case of ice forming on a pond the conditions favor stratification; the cooling surface is the top; the coolest water, approaching the freezing-point, is the lightest and tends to rise (assuming that the whole of the water is below 8° C.); here ice forms; so that the lighter substance, the ice, here comes into existence at the top, and readily retains this natural position. But if we freeze water in a small iron crucible with roughened sides, and especially if we cover the upper surface of the water with sawdust to retard the removal of heat there and concentrate the cooling and freezing on the rough sides of the crucible, then the freezing will occur first along these rough sides, and the particles of ice as they form will tend to adhere to them rather than to rise to the top by gravity.

In the freezing of metallic masses we have a like effect. Freezing occurs most rapidly at the bottom and sides against the cool mould-walls, and more slowly at the top, to which the convection currents carry the hottest and lightest part of the molten metal. So the metal which first freezes forms a thin hollow cup along the sides and bottom of the mould, a cup which even if it

should be lighter than the molten metal would be restrained from rising by its adhesion to the mould-walls, and often by its very shape. The next layer to form attaches itself to this first, and so on.

Other reasons lead in the same direction. In case of a lead-tin-alloy, Fig. 28 *F*, because the freezing of the alloy is usually rapid, because the crystals of tin which freeze out from *B* to *C* are not only extremely minute but also very near in density to the mother-metal in which they form, and because the mother-metal itself during their formation is relatively viscous, at least when compared with an aqueous solution, the crystals of tin do not necessarily remove themselves bodily out of the mother-metal, as ice forms on the surface of a pond, but remain mechanically entangled in it or attached to the sides of the mould; and on examining under the microscope a polished section of the solid alloy, we find the little crystals of this excess of tin distributed through the mass with a uniformity of about the same order as that of the crystals of feldspar in a granite. It is no doubt for like reasons that, in our crystalline rocks, minerals varying considerably in density occur side by side, instead of being stratified according to their density.

If we were to cool our alloy so extremely slowly that its freezing occupied many hours, under favorable circumstances we might find a stratification according to gravity. This indeed is what happens in the peculiarly favorable case of the graphite of cast iron very slowly solidifying in the "mixers" of the great steel works. The graphite is so much lighter than the iron in which it forms, and the solidification is so extremely slow, that much graphite rises to the surface as "kish" and blows about the building. (§ 185, p. 210.) And in certain other alloys, the constituents of which differ much in density, stratification can be detected with a microscope. Indeed, in the case of the tin-antimony alloys, the microstructure of which is shown in Figs. 16 and 37, pp. 46 and 89, the cubes which form during freezing may, if the freezing is very slow, reach such a size and may be so free from attachments to the already solid walls of the freezing mass, that they swim to the top, and after the alloy has cooled can there be seen in a section properly prepared for this purpose. Fig. 16 shows how these little cubes have thus risen to the upper part of the molten mass.

38. MICROSTRUCTURE. — This genesis which we have been following, the freezing out first of the excess-substance and then later of the eutectic, is reflected in the microstructure. Thus in a microsection of a copper-silver alloy richer in copper than its eutectic ratio of 72 silver 28 copper, we find (Fig. 17) the excess of copper in small dark crystallites grouped together like a fern-leaf or pine-tree. Thus in freezing this copper has arranged itself around definite crystalline axes, the trunk and branches of the

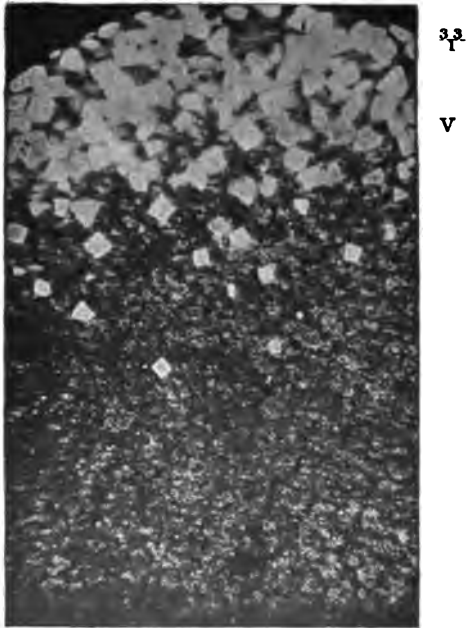

Fig. 16. Alloy of 90 per cent Tin, 10 per cent Antimony. Showing how the Cubes of Tin Antimonide (Sn Sb) have risen by Gravity to the Top of the Ingot. Vertical Section of the Ingot. Prepared by William Campbell in the Author's Laboratory.

pine-tree, and in doing so has displaced the still molten eutectic, which, on later reaching its own freezing-point, has solidified in these spaces into which it has thus been driven between the pine branches.

And here we have a first example of the kind of evidence that guides us in deducing from the microstructure the order of

birth of the different constituents. It is a natural principle that the earlier born constituents should assume their own crystalline forms, since at the time when they are solidifying the remainder



Fig. 17. Eutectiferous Copper-silver Alloy, Heat-tinted.

C. H. Eckerson and the Author.

The dark fern-leaf crystals are the excess-metal, argentiferous copper. The eutectic is shown both in plate and spheroidal shape.

EXCESS AS NETWORK, EUTECTIC AS MESHES.



Fig. 18. Alloy of 80 per cent Copper, 20 per cent Silver.

The eutectic is Levol's alloy, copper 28.1, silver 71.9 per cent. The black arborescent network is the excess of copper over the eutectic ratio.

Prepared by E. J. Hall in the Author's Laboratory for this work.

of the mass is still a molten menstruum, in which they are free to grow ; whereas the constituents which form later, through later freezing, find themselves at birth already displaced by their elder

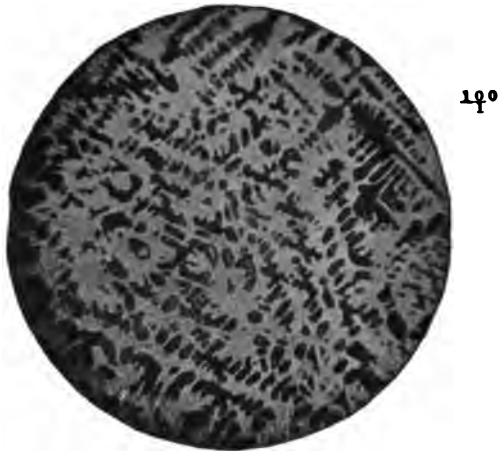

Fig. 19. White Cast Iron, Etched with Tincture of Iodine.
(F. Osmond, Private Communication; see also *The Metallographist*, III, 197.)

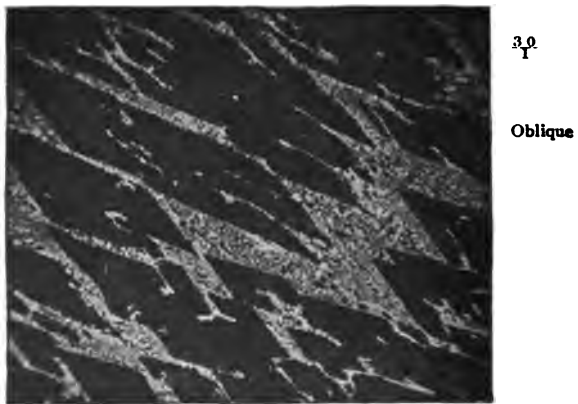

Fig. 20. Alloy of Copper 45 per cent, Aluminium 55 per cent.
Made in the Author's Laboratory by William Campbell.

brothers, and occupying the spaces between them, the only space that is left. In short, the early freezing substances would naturally form "idiomorphic" crystals or crystalline groupings, while

the later freezing ones would naturally be grouped pseudomorphically. (For definitions see § 39, p. 51.)

Now, a pine-tree or fern-leaf crystalline grouping, like that in Fig. 17, certainly appears to be idiomorphic. Even if we did not know the history from other data, we should say that this fern-leaf is an early-born substance, and the eutectic between is of later birth. This is shown even more clearly in Figs. 18 and 19, the dark rows of semi-arborescent crystals in which are evidently free growths in a menstruum at least mobile enough to enable the growing tree or bough to push it aside.

The interpretation of polygonal structure, like the dark network* and light polygons of Figs. 1 and 2, pp. 3 and 4, needs more care, because each constituent might be at first sight reckoned either idiomorphic or pseudomorphic. But the fact that spines of the dark network protrude into the light meshwork,* and that well-oriented stripes of the former occur in the latter, indicates that the former is the earlier formed; for if the network were formed after the polygons had already solidified, it is less likely that its nascent spines and stripes could thus have thrust themselves into the already relatively firm polygons. In case of Fig. 1, we know from Osmond's independent data, embodied in Roberts-Austen's diagram, Fig. 68, p. 194, that the dark network of ferrite is of earlier birth than the light polygons of pearlite. (See § 169, p. 198.)

Further examination of this type of structure as shown in Figs. 21 to 23, p. 50, goes farther to show that the network of the excess-substance ferrite (shown in these three figures as the lighter constituent) is older than the meshwork or matrix-substance, the quasi-eutectic or æolic pearlite, because of the way in which the fine spines of the former shoot out into the latter.

But in other cases it is the eutectic which forms the network and the excess-metal the meshwork or polygons, as in Fig. 20. Here, then, the polygons are the earlier and the network the

* For the benefit of any to whom the distinction between the terms "network" and "meshwork" may not be perfectly clear, the following definitions from Webster's Dictionary are given:

Network — A fabric of threads, cords, or wires crossing each other at certain intervals, and knotted or secured at the crossings, thus leaving spaces or meshes between them.

Mesh — The opening or space enclosed by the threads of a net between knot and knot.

EXCESS AS NETWORK, EUTECTIC AS MESHES.



33

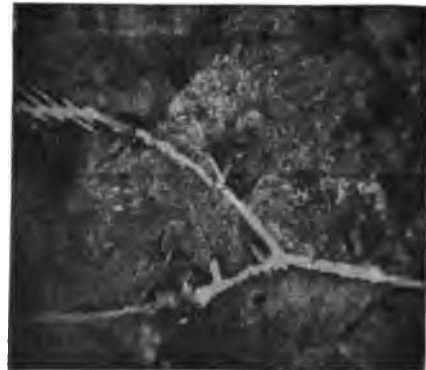

65



400

Fig. 21.

Fig. 22.

Fig. 23.

Figs. 21 to 23. Showing how the Network of Excess-substance (Ferrite) Shoots its Spines out into the Acolic (Pearlite).

From an Ingot of Hypo-eolic Steel.

Carbon 0.56, Silicon 0.14, Manganese 0.18, Phosphorus 0.02, Sulphur 0.02.

Made by W. A. Bentley in the Author's Laboratory for this work. All are from the same region in the same specimen.

Fig. 21 shows the network and meshwork arrangement. Fig. 23 is enlarged so as to show the pearlite structure.

Fig. 22 serves to connect the others.

later born, in contrast with the condition of affairs in Figs. 1, 2 and 18.

This diversity of arrangement, this having the excess-substance form in some alloys the network and in others the meshes, is due to a corresponding diversity in the way in which the earlier formed, the excess-substance, crystallizes. With the great diversity in the forms which ice assumes under different conditions we are all familiar, the transcendently beautiful hexagonal stars which snow forms on some very cold days, the arborescent tracery on our window-panes and even at times on the sidewalks, the stout columnar structure of our artificial ice ingots. And like diversity is found in many minerals.

In general, where in any given alloy the excess-substance forms arborescent or hollow crystals, or crystals which enclose space, it tends to form the network, leaving the eutectic to occupy the meshwork thus left between the crystalline branches or plates. And where, instead of forming arborescent, hollow, or other crystalline forms enclosing space, the excess-substance forms solid crystals, each of which grows from a centre, growing as a solid cube for instance from some starting-point, then the excess-substance tends to form the meshwork, expelling into the spaces between these crystals the mother-metal, which will eventually turn into the eutectic. At first these intercrystalline spaces occupy the greater part of the whole mass; but with the growth of the individual crystals, the intercrystalline spaces are progressively encroached upon, and are later reduced to a mere network. These generalizations are not intended dogmatically or as of universal application, but rather to suggest to the student the manner of growth, and to aid in deducing from the crystalline arrangement the seniority of the different components.

39. DEFINITION. — An idiomorphic or automorphic crystal is one with a shape due to the crystalline nature of the substance of which it is composed, as distinguished from a pseudomorph, *i.e.*, one with a shape due to other causes, such as the shape of the space in which the substance is confined, the shape of a previously existing substance which it replaces, *etc.*

Valuable evidence as to seniority can often be had by examining the different constituents with a view to deciding which of them on one hand exist in idiomorphic crystals, or in shapes indicating that they have formed freely in a liquid or plastic

medium, and which simply occupy the spaces left by the earlier formed crystals of other constituents. This criterion must, however, be used with great caution. Thus in Fig. 20, p. 48, certain off-shoots of the eutectic into the dark ground mass might readily suggest that they were idiomorphic. But, on closer examination, we see that these spines really follow the orientation of the dark crystals, so that the eutectic, instead of having sent out early spines which have persisted, has simply occupied certain spaces left within the crystals of the earlier formed constituent.

CHAPTER III. — FREEZING-POINT CURVES

40. PHYSICAL PROPERTIES OF SERIES OF ALLOYS, OR THE GENERAL SYSTEM IN WHICH THE CHANGES IN ANY GIVEN CRITICAL POINT OR CRITICAL COMPOSITION OCCUR AS WE PASS FROM ONE END OF A SERIES TO ITS OTHER END. — The importance and indeed the meaning of this class of studies can best be seen after we have examined an individual case, of which the “freezing-point curve” is probably the most important.

41. FREEZING-POINT CURVE. — In the cooling curves in Figs. 8, 9, 11, and 28 *B, C, D* and *F*, pp. 18 and 60, we may note two critical temperatures, *B* at which the freezing of the excess-substance begins, and *CD* at which it ends and the freezing of the eutectic occurs. For brevity we may call these the two freezing-points, *e. g.*, for each alloy of lead with tin. Now, to bring together and compare the teaching of all these cooling curves and to see in what manner these freezing-points vary, as we pass from pure lead through the lead-tin alloys to pure tin, we may plot, as in Fig. 24, p. 54, with temperature as ordinate and percentage of tin as abscissa, the position of these two freezing-points, when we find that the upper freezing-points fall into a V-shaped curve, *ABC*, underscored by a horizontal line *aBc*, the freezing-point of the eutectic.* Let us here

* Let the reader clearly impress on his mind at the outset that each point in this and like diagrams represents both a specific temperature through its vertical distance from the horizontal axis, and a specific composition through its horizontal distance from the vertical axis. For instance, the point *B* represents the temperature of 180° through its height, and it also represents the composition lead 31 per cent, tin 69 per cent, through its distance to the right of the axis *OA*.

at once recognize this, the essential feature of this family of curves, the underscored V. The line AB is the locus of the temperature at which lead begins to freeze out from molten lead-tin alloys which contain an excess of lead over the eutectic ratio of 31 per cent, starting with 326° C., the melting-point of pure lead, and ending with 180° , the freezing-point of the eutectic. So, too, BC is the locus of the temperature at which the freezing of tin begins in case of all alloys of lead with tin containing less than 31 per cent of lead, or in other words containing an excess of tin over the eutectic ratio. The line aBc represents the temperature at which the eutectic freezes in each alloy.*

42. TWOFOLD ASPECT OF THE V-CURVES.—We saw in § 29, p. 33, that during selective freezing the mother-metal was at every

* To make perfectly clear the relation between the freezing-point curve and the individual cooling curves, of the two freezing-points of which it gives the loci, let us follow the cooling of some one alloy, say that of 55 per cent of lead, and hence with 24 per cent excess of lead over the eutectic ratio. Let us assume that the molten alloy has been first superheated above its melting-point, say to 350° , G. Following the course of its cooling along the line $GHJK$, it cools past 326° , the freezing-point of lead, without undergoing any freezing; the lead remains molten at a temperature below its own freezing-point, because the new substance, the molten solution, which its integration with the tin forms, has a lower freezing-point; the tin dissolved in the lead lowers the freezing-point of the lead. Only when the temperature falls to about 225° C. does any lead begin to freeze. As the temperature further falls from H to J , crystals of lead continue freezing out within the molten metal, while the mother-metal, or part still remaining molten, thereby grows correspondingly and progressively richer in tin and leaner in lead. This continues until the temperature has reached 180° , when the molten mother-metal will have become so far impoverished in lead as only to contain 31 per cent of that metal; in short, it will have reached simultaneously the freezing-point of the eutectic and the composition of the eutectic. At this point further cooling is arrested by the heat liberated through the solidification of the eutectic; and only when the whole of the mother-metal shall have frozen, yielding the well-known interstratified plates of the eutectic, only then will the temperature again begin to fall. In this line then, GH corresponds to the part AB of the cooling curve in Fig. 28D; HJ represents the excess-freezing period and corresponds to BC ; the point J represents the jog CD , the eutectic-freezing period; and JK represents the part DE . The fact that the line aBc is horizontal represents the fact that the jog BD has the same ordinate, *i. e.*, that the eutectic freezes at one and the same temperature, no matter what the initial percentage of lead and of tin in the molten alloy is.

instant at its then freezing-point; that as the temperature progressively fell, so the composition of the mother-metal shifted through selection, in such a manner that its composition at any instant was that for which the freezing-point was the then existing temperature. Now, since AB is the locus of the freezing-points for all different compositions between lead 100 and lead 31 per cent, it follows that during this selective freezing it is also the locus of the temperature and composition of the mother-metal throughout selective freezing. Thus starting with a given composition, say lead 55, tin 45, GK , Fig. 24, freezing begins at 225° (H), and as freezing proceeds, both the composition and the tem-

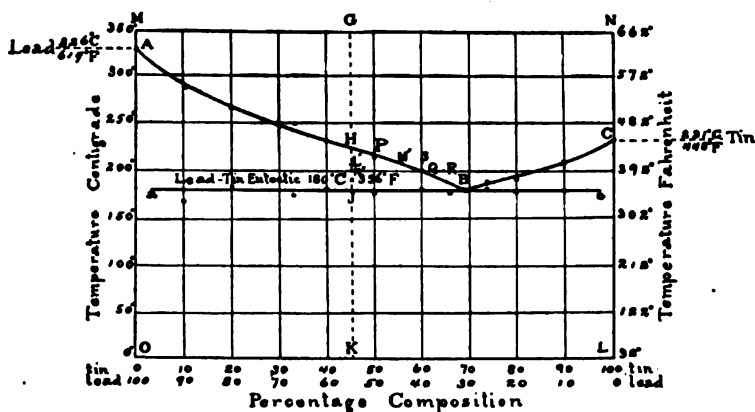

Fig. 24. Freezing-point Curve of the Lead-tin Alloys.

Roberts-Austen, *Fourth Rept. Alloys Research Committee*, Fig. 5, Plate 4, 1897.

perature of the mother-metal are continuously represented by points on AB ; or in other words the temperature and composition of the mother-metal slide along AB from H to B .

The lines AB and BC then have a twofold meaning; for varying initial composition of the molten mass they are the loci of the temperature at which freezing begins; while for given initial composition they are loci of the temperature and composition of the mother-metal during selective freezing.

43. PROLONGATION OF THE V-CURVES BEYOND THEIR APEX. — In certain cases the V-branches AB and CB of the freezing-point curve have been traced beyond their intersection, as shown in

Fig. 25. This has been done independently by Le Chatelier,* Dahms,† and Roberts-Austen.‡ Fig. 26 gives the cooling curve of the alloy of tin 64 per cent, lead 36, represented by the points

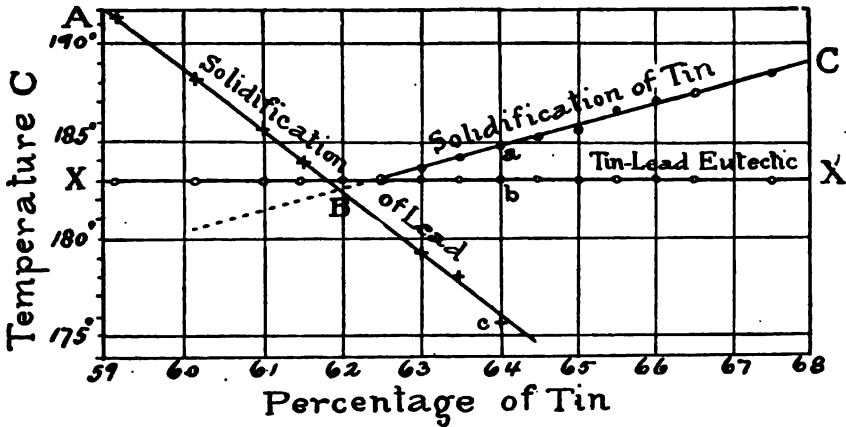

Fig. 25. Freezing-point Curve of Lead-tin Alloys.
Roberts-Austen, *Proc. Royal Soc.*, LXIII, p. 452.

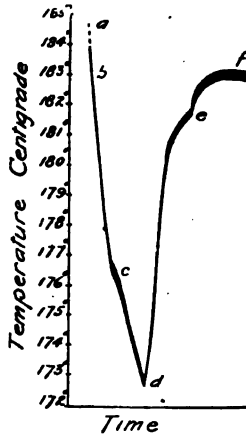

Fig. 26. Cooling Curve of Surfusation in Lead-tin Alloys; Tin 64 per cent;
Lead 36 per cent.

Roberts-Austen, *Proc. Royal Soc.*, LXIII, Pl. 9.

* Le Chatelier, *Comptes Rendus*, April 9, 1894.

† Dahms, *Ann. Phys. Chem.*, LIV, p. 386, 1895.

‡ Roberts-Austen, *Proc. Royal Soc.*, LXIII, p. 452, 1898.

a, *b* and *c* in Fig. 25. The lettering on these two figures is made to correspond.

This phenomenon we refer to surfusion. That surfusion should occur is in agreement with what we have already seen in § 30, p. 35. That the point *d*, at which it is arrested, should lack connection with the freezing-point curves, should in fact be a temperature taken at random, needs no explanation. That, once surfusion is arrested and freezing sets in, the heat liberated should raise the temperature to the eutectic freezing-point, *bf*, is natural enough. But why does the retardation *c* come in the prolongation of the line *AB*, *i. e.*, why is it thus related to the normal freezing-point curve, and how comes it that these V-branches can thus be traced beyond their intersection? The interpretation of such phenomena should be cautious; the following explanation is offered tentatively.

Assume that in the molten state a solution of tin in lead is a different and distinct thing from a solution of lead in tin; witness the fact that in the freezing-point curve of the former, *AB*, instead of being a smooth prolongation of the freezing-point curve of the latter *CB*, instead of being joined to *CB* by means of a smoothly curved line, cuts *CB* sharply, as if the two lines *AB* and *CB* related to different bodies.

Assume that these two molten solutions are soluble in each other, each in some sort preserving at least a potential existence, although thanks to the conditions of reciprocal solution, they cannot be separately detected, nor distinguished from each other.

Assume that in the present case the molten alloy of tin 64 lead 36 consisted of two distinct solutions, reciprocally dissolved, each solution dissolved in the other:

Solution 1, large in quantity, consisting of lead dissolved in tin in the ratio of 64 of the solvent (tin) to 36 of the solute (lead).

Solution 2, small in quantity, consisting of tin dissolved in lead in the ratio of 36 of the solvent (lead) to 64 of the solute (tin).

The normal freezing-point of solution 1 is temperature *a*.

The normal freezing-point of solution 2 is temperature *c*, in the direct continuation of the line *AB*.

Assume that in normal freezing without surfusion, when, on cooling to temperature *a*, solution 1 begins to freeze, solution 2

is converted into solution 1 by contact with the solid particles of solution 1, somewhat as one of two allotropic modifications can be transformed into the other by contact with a crystal of that other. Hence the absence of any retardation at temperature c in normal freezing unaccompanied by surfusion.

Assume that in the present surfusion it is simply solution 1 which surfuses; that when the temperature falls to c , the freezing-point of solution 2, this naturally freezes out, causing the retardation c in the cooling curve. The slowness of this retardation corresponds to the assumed small quantity of solution 2.

Assume that, for whatever reason, so strong is the tendency of solution 1 to surfuse, that it persists unfrozen even through this freezing out of solution 2.

Here then we have an explanation of the fact that the retardation c comes in the prolongation of AB , which is what we started out to explain.

44. OTHER CRITICAL CURVES FOR TEMPERATURE AND COMPOSITION. — Digressing for a moment, let us notice that, just as the freezing-point curve shows the relation between the composition of the alloy as a whole and the position of these two critical freezing-points, so on this same temperature-composition diagram we may show simultaneously various other critical matters.

Thus, in § 98, p. 116, we shall see how the relation between temperature and solvent power is shown by what are usually called "critical curves," but are called in this work "saturation-point" curves.

Again, in § 114, p. 135, we shall see how the course of selection in freezing is expressed by the temperature-composition curves of the frozen part, on the assumption that diffusion has made this part homogeneous.

Finally, in § 121, p. 144, we shall see how the course of selection in freezing is expressed by the temperature-composition curves of the layers in the act of freezing at each instant.

From these curves themselves further inferences can be drawn, can as it were be read on the diagram itself. For instance, from the freezing-point curves we read also the course of selective freezing as it is expressed in the composition of the remaining molten mother-metal at each instant; and the constitution of the frozen mass, as related to the composition of the alloy as a whole. Again, the saturation-point curves also teach this relation

between constitution on one hand and temperature and composition of the alloy as a whole on the other hand.

By placing two or more of these curves on the same diagram, we may see how these various critical matters are related to one another.

To sum up, we have

- (1) the freezing-point curves,
- (2) the saturation-point curves,
- (3) the temperature-composition curves of the frozen part,
- (4) the temperature-composition curves of the freezing layers.

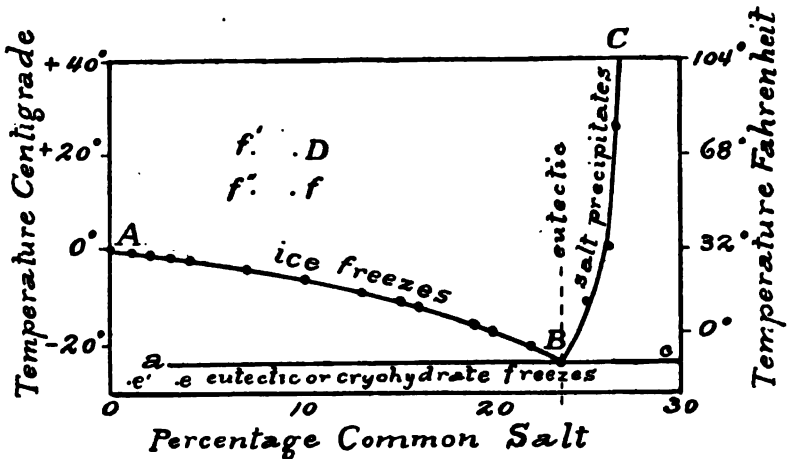

Fig. 27. Freezing-point Curve of Solution of Common Salt in Water.
Guthrie, *Phil. Mag.*, 5 Ser., I, p. 359, 1876.

Let us now return from this digression to consider the first of these sets of curves, the freezing-point curves.

45. FREEZING-POINT CURVE OF SALT WATER. — If, now, proceeding as we did in §§ 41 and 42 with the freezing-points of the lead-tin alloys, we assemble as in Fig. 27 the freezing-points of all possible solutions of salt and water as shown in Figs. 7 to 11, p. 18, and plot them in a freezing-point curve, we find that we get a curve of the same general family, the underscored V. One branch *AB* of the V represents the points at which the water begins freezing out from solutions containing an excess of water over the eutectic ratio of 23.6 per cent, and the other branch

BC represents the points at which salt begins freezing out or precipitating from solutions containing initially an excess of salt above the eutectic ratio. The horizontal branch or line aBc underscoring the V , represents the freezing of the eutectic of 23.6 per cent of salt and 76.4 per cent of ice. We see that we have an exact correspondence between the behavior of alloys of the lead-tin class in freezing and that of aqueous solutions, in the shape and meaning of the freezing-point curve, and in the constitution of the frozen mass.

46. COOLING AND FREEZING-POINT CURVES SHOWN SIMULTANEOUSLY. — Fig. 28, pp. 60, 61, represents an attempt to show simultaneously the cooling and the freezing-point curves of the lead-tin series of alloys. First we have the cooling curves for various compositions, Figs. 28 A to 28 G , the several curves being so spaced apart that the horizontal position of the axis OA in each corresponds to the percentage of tin in the alloy to which the curve applies. Suppose that we now pass a black tape through all the points B , and another through all the points C . Suppose that each cooling curve is hinged at its axis OA , and is now rotated 90° to the left, so that, instead of lying in the plane of the paper as in Figs. 28 A to 28 G , each curve stands out at an angle as in Fig. 28 H . The two tapes now reproduce the freezing-point curve ABC and aBc of Fig. 24, while the several cooling curves remain visible.

CHAPTER IV. — CONSTITUTION OF BINARY ALLOYS WHICH FORM NO DEFINITE CHEMICAL COMPOUND

47. CONSTITUTION TO BE EXPECTED IN CERTAIN TYPICAL CASES. — Let us next consider what constitution we should expect in certain typical cases, premising that this sort of forecast may have to be modified considerably by later investigations. In the present chapter we will for simplicity consider cases in which the two metals form no definite chemical compound with each other, and we will see how their constitution should be affected by the assumptions (1) that (when solid) they are wholly insoluble in each other, (2) that they are reciprocally soluble in all proportions, and (3) that their reciprocal solubility,

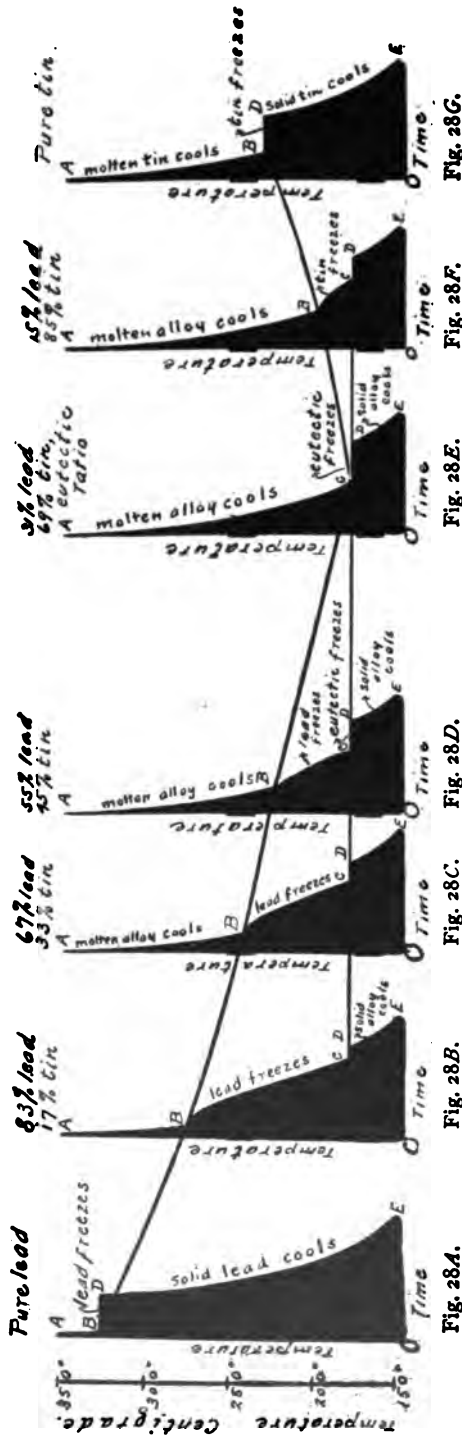

Figs. 28A to 28H. Cooling and Freezing-point Curves of the Lead-tin Alloys, shown simultaneously.

Figs. 28A-G and Fig. 28H give two views of a lecture model made to show the relation between the cooling and freezing-point curves. The cooling-curve vanes are hinged along *AO*, and Figs. 28A-G give a front view with the vanes shut, *i.e.*, flat against the back of the model. Fig. 28H shows the vanes opened, at right angles to the back of the model.



Fig. 28H.

while considerable, is limited. Each of these three assumptions refers to reciprocal solubility in the solid state.

In the last of these cases, if there is present a very large quantity of either metal with a very small quantity of the other, this small quantity dissolves in the larger one; but if the quantities of the two are more nearly equal, then there may be more of each than the other can dissolve.

48. IF TWO METALS ARE INSOLUBLE IN EACH OTHER WHEN SOLID, ALL THEIR ALLOYS SHOULD BE EUTECTIFEROUS. — The assumed complete insolubility of solid salt in solid ice, and of solid lead in solid tin, should cause all salt-ice, and all solid alloys of lead and tin, to be eutectiferous; in other words, if this insolubility were complete, then every salt-water solution and every lead-tin alloy when frozen would contain more or less of the eutectic, no matter how little salt the water initially contained, or how little lead the tin contained, or vice versa.

49. WHY SUCH A SERIES IS EUTECTIFEROUS THROUGHOUT. — The reason for this is first that the selection in freezing ought to be rigid; and second that rigid selection must eventually lead to the formation of a eutectic, no matter what the initial proportions of the two metals.

For our reason for the rigidity of the selection, let us return to the explanation offered in § 21, p. 26, of the selectiveness of the freezing of a salt-water solution, and apply it to the freezing of molten alloys of lead and tin. If we assume that these two metals are wholly insoluble in each other, and try to picture to ourselves that selection is not rigid, we find the idea unnatural, if not indeed untenable; so that rigid selection is what we naturally expect. For if in case, say of an alloy of much lead with little tin, selection were not rigid, so that a given minute layer in freezing out consisted not of lead alone but of lead with some tin, then the assumed complete insolubility of the two metals implies that the tin must be in distinct flakes, separate from the flakes of lead. But these flakes of tin certainly ought to redissolve and reënter the molten mother-metal, for the sufficient reason that the alloy which this reëntry would cause would be fusible, *i. e.*, could remain molten, at the existing temperature. And since the flakes of tin thus imaginarily deposited would in the very act of forming be exposed to the molten mother-metal, their opportunity to redissolve would be

most favorable, and all of them ought to redissolve completely, so that in effect only pure lead should permanently freeze, *i. e.*, the selection in freezing should be rigid.

The next following particles to freeze would for like reasons be pure tin-less lead, and this process of rigid selection and consequent extreme enrichment of the mother-metal in tin should continue. Should it continue indefinitely, eventually all the lead would have frozen out and only pure molten tin would be left, no matter how little tin were initially present. But as explained in § 29, p. 33, this selection ought of course to end when it has enriched the mother-metal up to the eutectic or most fusible ratio: once this ratio is reached no further selection in freezing should occur, for the sufficient reason that no selection can yield a mother-metal of lower freezing-point. Hence when the mother-metal is enriched up to the most fusible or eutectic composition, and simultaneously the temperature has fallen to the freezing-point of this eutectic and tends to descend below it, the mother-metal now freezes unselectively into the eutectic. Hence, the rigidity of the selection causes the enrichment of the mother-metal to reach the eutectic ratio, and this in turn causes the formation of a eutectic, no matter how little lead is initially present, and, by like reasoning, no matter how little tin is initially present, in short no matter what the initial composition, Q. E. D.

50. WHY THIS EUTECTIC IS COMPOSITE. — The eutectic should be composite for the same reason as in the case of salt water (§ 31, p. 38). The assumed insolubility of solid lead and solid tin in each other implies that each of these in the solid state must be free from the other, and hence that the particles which each forms must be distinct from those in which the other exists.

51. SERIES OF ALLOYS RARELY EUTECTIFEROUS THROUGHOUT. — Here let us note that those series of alloys which are apparently of the first type, that which is eutectiferous throughout, may on further examination prove to be of the third or partly eutectiferous type. For that a series should be eutectiferous throughout implies absolute reciprocal insolubility of its component metals. We may doubt whether this often occurs. It is probable that in most cases there is at least a slight reciprocal solubility, so that a short space at each end of the series is non-eutectiferous. The wholly eutectiferous type, then, is one which

is approached, but probably rarely reached. The salt-water and the tin-lead cases were assumed to be of this type, to help explain the general features of the constitution of alloys.*

52. IF TWO METALS ARE SOLUBLE IN EACH OTHER WHEN SOLID, SOME OR EVEN ALL OF THEIR ALLOYS SHOULD BE NON-EUTECTIFEROUS. — We have now seen that, if two metals when solid are absolutely insoluble in each other, all of their alloys should be composed (1) of the eutectic and (2) of the excess-metal, *i. e.*, of the metal present in excess over the eutectic ratio. But the case will be very different if the metals are soluble in each other when solid. Let us consider two cases, that of the silver-gold alloys, two metals which even when solid dissolve in each other in all proportions, and that of the bismuth-tin alloys, metals each of which can dissolve a limited but still a very considerable quantity of the other when solid.

53. SIX FEATURES OF THE GENESIS AND CONSTITUTION OF WHOLLY NON-EUTECTIFEROUS SERIES: SILVER-GOLD TYPE. — If two metals are soluble in each other in all proportions when solid,

(1) their freezing is indeed selective, but

(2) the selection is not rigid, *i. e.*, the layers which freeze out instead of being, as in the lead-tin case, the excess or solvent metal wholly free from the deficit or dissolved metal, are an alloy of the two metals, but richer in the excess-metal than the initial molten mass was: so that as freezing proceeds, though the mother-metal indeed becomes progressively enriched in the dissolved metal, yet that enrichment is not extreme, as it was in the lead-tin case,

* The quasi-alloys of iron with carbon indeed present two cases in which the insolubility appears to be complete. The first of these is the graphite or "kish," the excess-substance in cast iron containing more than 4.30 per cent of carbon. Its freedom from iron is certainly nearly and perhaps quite complete. (See Fig. 68. Compare also Percy, "Iron and Steel," p. 511. Dr. Percy indeed found evidences that this kish contained silicon, but his failure to record the presence of iron goes to show that none was present, to judge from his habits. See also "Principles of the Manufacture of Iron and Steel," Bell, p. 156.) The other case is that of the iron which separates out as ferrite from the austenite of slowly cooling steel, in passing through the critical range. This appears to be wholly free from carbon. (*Fifth Rept. Alloys Research Committee*, p. 50.) But more delicate observations are needed to establish firmly the completeness of insolubility even in these cases.

(3) as the mother-metal becomes progressively enriched in the deficit or dissolved metal, so the layers which freeze out from it are successively richer and richer in the dissolved metal,

(4) while one alloy of the series is strictly speaking a eutectic,

(5) it is not composite, and

(6) all the other alloys of the series are non-eutectiferous, in the sense of being free from a composite eutectic of the usual type.

Of these six facts, the fourth is a direct consequence of our definition of a eutectic, and the others are natural consequences of our conditions, as will shortly be explained.

Reasons for this Genesis and Constitution

54. FREEZING SELECTIVE, BUT THE SELECTION SHOULD NOT BE RIGID. — Taking up the first two of our six facts, let us consider the case of an alloy of 60 per cent of gold and 40 per cent of silver, premising that pure silver is apparently more fusible than any of its alloys with gold, and that the freezing-point descends continuously as the percentage of silver increases from 0 to 100. (Fig. 29, p. 67.)

First, if freezing is to be selective, in which direction should the selection be? Here we must look upon gold as the excess-metal, because there is more gold than that which corresponds to the eutectic ratio, which really is silver 100, gold 0. (See § 56, p. 66.) Hence if there is any selection, it should be that the layers freezing out are richer in gold, the excess-metal, than the initial mother-metal is.

Next, if we ask whether this selection should or should not occur, we see that we have the same reason as in our salt-water case (§ 21, p. 26) why it should, *viz.*, that if we conceive that it does not, but that the first deposited flake is of the 60:40 ratio, its silver should tend to redissolve and reënter the molten mother-metal, because the alloy which that reëntry would create would contain more than 40 per cent of silver, and would therefore be fusible and remain molten at the existing temperature, which by assumption is at the freezing-point of a 40:60 silver-gold alloy; because every increase of silver lowers the melting-

point of silver-gold alloys. In short the conception of unselective freezing is unnatural, so that selection is what we naturally expect.

But we should not expect selection to be rigid in the sense that the whole of the silver would remelt and reënter the mother-metal, so that in effect only pure gold should freeze, because that remelting and reëntry is opposed by the mild force which in any given frozen flake holds together the two metals, the solvent and the solute. Therefore it is natural that the struggle between the tendency of the silver to remelt and reënter the molten mother-metal, and the bond between the two metals in that flake holding them together and opposing the removal of the silver from the gold, should result in a compromise: we should expect part of the silver to remelt and part to remain frozen, so that, while freezing should be selective, the selection should not be rigid, which is what we set out to explain.

55. THESE REASONS CONTINUED: HETEROGENEOUSNESS OF SOLID SOLUTIONS. — To say that freezing is selective is to say that the mother-metal becomes progressively enriched in silver as freezing proceeds. That this progressive enrichment should be accompanied by a corresponding enrichment of the layers which freeze out so that each layer is richer in silver than the preceding, is so natural that no explanation is required.

But to assert this progressive enrichment of the successive layers is equivalent to saying that the solid solution as deposited is initially heterogeneous. Diffusion of course tends to efface this heterogeneity. In § 86, p. 101, we will consider whether this effacement ought to be complete, or whether a remnant of this initial heterogeneity ought to persist.

56. ONE MEMBER OF THE SERIES A EUTECTIC. — In any such series there must indeed be one alloy which is more fusible than any of the others; and this, following Guthrie's definition, is a eutectic. As silver appears to be more fusible than any of its alloys with gold, so in a sense it is the eutectic of the silver-gold series; and there is no break in the rise of the freezing-point as we pass through the series from pure silver to pure gold (Fig. 29). But in other series of alloys of two metals reciprocally soluble in all proportions at and even below their freezing-points, some one alloy might be more fusible not only than all the others but than either component metal, as in the

case of mercuric bromide and iodide, Fig. 44, p. 118. Such an alloy would be the eutectic of the series.

57. THAT EUTECTIC NOT COMPOSITE. — But this eutectic would be a solid solution, instead of consisting of interstratified plates of two distinct substances as in the salt-water and lead-tin cases. The reason is obvious. The reason why the salt-water and the lead-tin mother-metals froze on reaching the eutectic enrichment, was that they simultaneously reached the freezing-point of the eutectic, the lowest freezing-point of the series; freezing should not be deferred by further enrichment, because such enrichment would only raise the freezing-point. But the

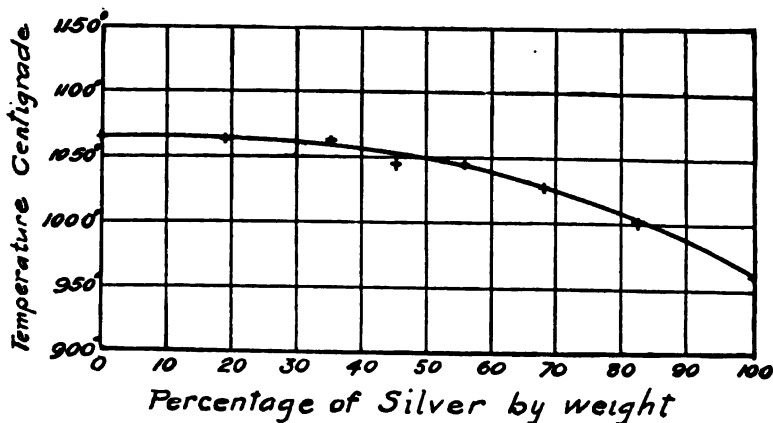

Fig. 29. Freezing-point Curve of Silver-gold Alloys.

Plotted from the data of Sir W. C. Roberts-Austen and T. K. Rose,
Proc. Royal Soc., Vol. LXXI, p. 162.

reason why the eutectic on freezing splits up into alternate plates of ice and salt, lead and tin, was a different one: it was that each substance when solid is insoluble in the other. Now this latter reason does not apply to our gold-silver type of alloys. As their metals are soluble in each other in all proportions, so no matter to what composition the eutectic corresponds, there is no reason why it should in freezing split up into different layers. So the absence of the composite structure from the quasi-eutectic alloy of the series is a natural consequence of the complete reciprocal solubility of the two metals.

58. THE OTHER ALLOYS OF THE SERIES NON-EUTECTIFEROUS. That no composite eutectic should form in any alloy of the series is in accordance with the reasoning in the last section.

But it appears that not even a non-composite eutectic forms, *i. e.*, that enrichment of the mother-metal does not proceed so rapidly as to bring any finite quantity of the mother-metal to the most fusible, *i. e.*, eutectic composition; so that no finite quantity of even the non-composite or quasi-eutectic forms. While further observations are needed to establish this as a general law, it would not be an unnatural one. Complete reciprocal insolubility of two metals forces selection to be rigid and the enrichment of the mother-metal to be extreme. But when two metals dissolve in each other without limit, it would not be unnatural that, as through the enrichment due to selective freezing the composition of the mother-metal approaches the eutectic ratio, the selection should become milder and milder, so that that approach should be asymptotic.

Further, however this may be, even if the enrichment of the later-frozen layers should bring them up to the eutectic ratio, diffusion into the poorer layers earlier deposited should tend to impoverish them below that ratio:

59. SHAPE OF THE COOLING CURVE. — The cooling curve for alloys of this class should be like that of Fig. 30. This resembles those of the eutectiferous alloys and of salt-water in having a rounded selective-freezing part *BC*, but it differs from them in lacking the eutectic-freezing part or jog *CD*.

60. IF THE RECIPROCAL SOLUBILITY OF TWO METALS WHEN SOLID IS LIMITED, THE SERIES OF THEIR ALLOYS SHOULD BE EUTECTIFEROUS IN THE MIDDLE BUT NOT AT ITS ENDS, AND THE EUTECTIC SHOULD BE COMPOSITE. — Tin when solid can dissolve a considerable proportion of bismuth, and conversely bismuth can thus dissolve tin.* Thus if there is present in the alloy as a whole a large proportion of tin and only a small proportion of bismuth, that bismuth can remain dissolved in the tin even after the whole has frozen. Conversely, if there is present in the alloy as a whole a large proportion of bismuth and only a small proportion of tin, that tin can remain dissolved in the

* A. W. Kapp, *Annalen der Physik*, 4th Ser., vol. VI, pp. 754-773, 1901.

bismuth even after the alloy has frozen. But there is the intermediate condition, in which there is more bismuth than the tin present can dissolve, yet not enough bismuth to act as the solvent and dissolve the whole of the tin. Under these conditions the alloy should be eutectiferous and its eutectic should be composite. The reasons for this have really been given already, but they may come out more clearly if we consider an individual case.

First we have the same reason as with the previous types (§§ 21, 49 and 54) why freezing should be selective, why as the freezing, *e. g.*, of an alloy of tin with a small quantity of bismuth, progresses, the mother-metal should become progressively enriched in bismuth, and the layers which successively freeze out should correspondingly become richer and richer in bismuth. Each layer should be richer in bismuth than the preceding layer, although each layer is poorer in bismuth than the then existing mother-metal. Now, should this enrichment of the mother-metal be so slight that even when its last particle freezes, it shall not contain more bismuth than the tin is able to retain dissolved when solid (say N per cent of bismuth), no composite eutectic should form; the enrichment should be continuous: there will be no reason why even the last frozen flake of the alloy should in freezing break up into a composite mass. Such is the state of affairs that we might expect if the initial quantity of bismuth dissolved in our tin is extremely small.

Suppose, however, that our initial molten tin contains a greater quantity of bismuth, so that a considerable quantity of unfrozen mother-metal shall still remain at the time when the composition of the layers in the act of freezing shall have reached this N per cent of bismuth. Up to this time each layer which has frozen has been richer in bismuth than the preceding one, simply because it has frozen out of a mother-metal richer in bismuth than that from which the preceding layer froze. In other words, the progressive enrichment in bismuth of the mother-metal has led to a progressive enrichment in bismuth of the successive layers; and this latter in turn has retarded the enrichment of the mother-metal, which has been gradual, instead of being extreme as in our salt-water and lead-tin types of assumed complete insolubility.

61. SUBSATURATION AND SATURATION DIVISIONS OF THE EXCESS-FREEZING PERIOD. — But at this point, when the tin which

freezes is just saturated with bismuth, the enrichment of the successive layers should cease; the layers henceforth deposited should be simply tin saturated with N per cent of bismuth; and the cessation of this enrichment should accelerate the enrichment of the mother-metal. The excess-freezing period may therefore be divided into two parts, the earlier in which the layers freezing out are unsaturated, and the later in which they are saturated, with bismuth. (See footnote to § 124, p. 147.)

62. SHAPE OF THE COOLING CURVE. — The cooling curve of a tin-bismuth alloy rich in tin, *i. e.*, of a bismuth-bearing tin, should be of the type of Fig. 31 or of Fig. 30, according to whether it does or does not contain so much bismuth that the layers of tin freezing out become saturated with bismuth before the whole of the mother-metal has frozen. In Fig. 31, BB' represents the subsaturation and $B'C$ the saturation division of the freezing of the bismuth-bearing tin, the excess-metal. It remains to be determined whether or no the two portions, BB' and $B'C$ of the curve fit each other tangentially, so that no critical point is visible. That such a critical point has not been observed may be due to our not looking for it.

63. MICROSTRUCTURE. — The sort of microstructure which would naturally result from the course of freezing, such as the cooling curve of Fig. 31 depicts, is that shown in Fig. 32, p. 72, a micrograph of a copper-tin alloy. In point of fact the actual constitution of this particular alloy has been disputed; and it is not necessary for our present purpose to decide as to what this constitution truly is. But we may reproduce this photograph for the purpose of showing simply what sort of microstructure ought to result from the course of freezing just depicted, admitting that this same structure might also result from other courses of freezing, and may have done so in this case.

The dark nuclei AAA are such as the excess-metal should form, freezing in the subsaturation period BB' of Fig. 31; the lighter bands BBB are such bands of the saturated alloy as should deposit in the period $B'C$ of Fig. 31; and the skeletons CC are such shapes as the eutectic might yield when freezing in period CD of Fig. 31. The gradual shading off between layers A and B of Fig. 32 is somewhat such a shading as should result from the progressive enrichment of the layers deposited during the subsaturation division BB' .

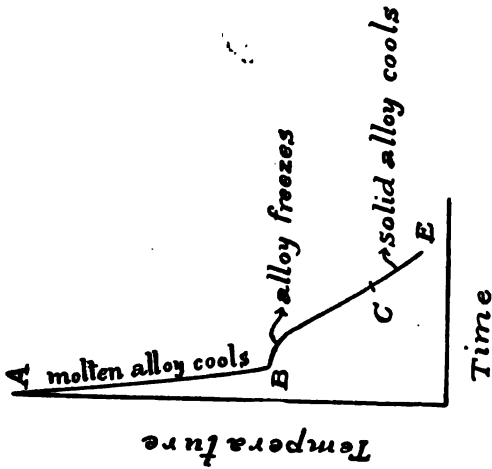

Fig. 30. Cooling Curve of a Solid-solution Alloy.

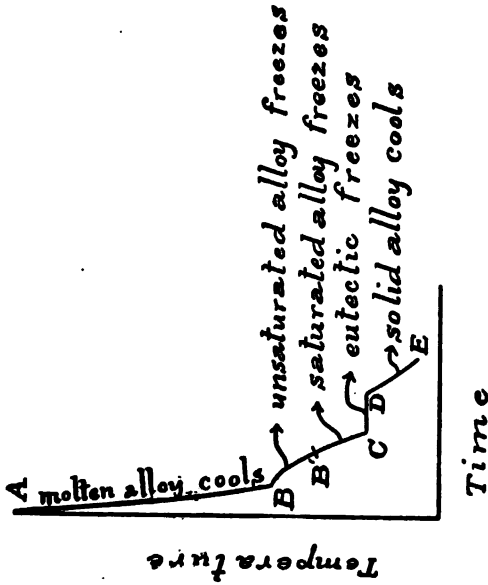

Fig. 31. Cooling Curve of a Eutectiferous Alloy of a Limited Solubility Series.

AB, Molten Alloy Cools.

BB', The Layers here Freezing are not Saturated.

B'C, The Layers here Freezing are Saturated, the Saturation-point progressively shifting.

CD, the Eutectic Freezes.

DE, the Solid Alloy Cools.

64. IF THE LAYERS FREEZING OUT REACH THE SATURATION-POINT BEFORE ALL THE MOTHER-METAL IS FROZEN, A EUTECTIC SHOULD FORM. — We have seen the general principle that the mother-metal at any given instant during selective freezing is richer in the dissolved metal (bismuth in our present case of bismuth-bearing tin) than the layers which are at that instant freezing out of it. It is in accordance with this principle that at the beginning of the saturation division when the bismuth in these layers reaches N per cent, the bismuth in the mother-metal must be more than N per cent of that mother-metal, say $N + n$ per cent of it.

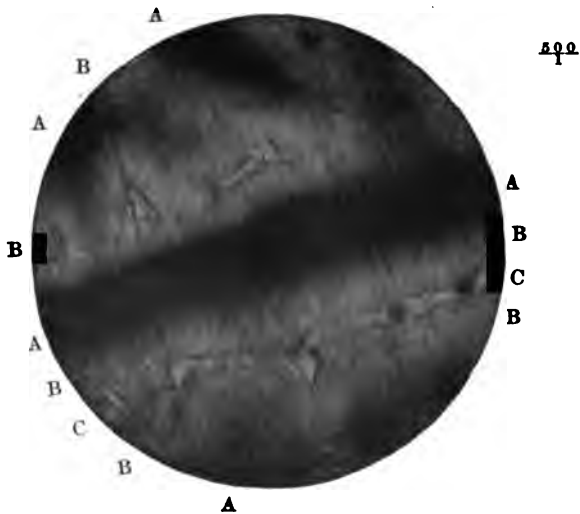

Fig. 32. Copper-tin Alloy, with Copper 90 per cent, Tin 10 per cent: $\times 90$.
Charpy, *Bull. Soc. d'Encouragement*, 5th Ser., II, 1897, p. 406, Fig. 27.
Also *The Metallographist*, I, 1898, p. 196, Fig. 17.

Quite as in all other cases, freezing should continue until the enrichment of the mother-metal in bismuth reaches the eutectic ratio. There may be but little further freezing before this enrichment is reached, or there may be much; but be there little or much, it is clear that the removal of layers containing only N per cent of bismuth from a mother-metal containing $N + n$ per cent, can never by any possibility remove the bismuth represented by this n per cent of the mother-metal at the time when the

removal of these N per cent bearing layers began. At least this n per cent of bismuth will be present at the time of reaching the eutectic composition, no matter how much or how little freezing out of N per cent layers occurs meanwhile. And as that mother-metal in freezing should, as in all previous cases, split up into the eutectic, some eutectic should (normally) form in any case in which the layers freezing out reach the saturation-point before the whole of the mother-metal has frozen.

65. THAT EUTECTIC SHOULD BE COMPOSITE. — The eutectic should be composite for the same reason as in the cases of salt-water and lead-tin (§§ 31, p. 38; and 50, p. 63). We have seen that the progressive enrichment in bismuth of the layers freezing out will continue until they become saturated with bismuth, containing N per cent; that the mother-metal will then contain more than this, and will during the ensuing freezing and its passage towards the eutectic ratio become still farther enriched in bismuth, in short, that the eutectic ratio corresponds to more than N per cent of bismuth. But as solid tin can (in equilibrium) contain only N per cent, when this eutectic freezes its excess of bismuth over N per cent cannot remain dissolved in its tin, but must separate out (if equilibrium is reached). Our eutectic then should consist of particles of tin saturated with bismuth, and other particles of bismuth, which as we shall see in §§ 69 to 74, pp. 75 to 84, for like reasons should be saturated with tin.

66. THE SATURATION DIVISION. — It has just been said that, during the saturation division ($B'C$, Fig. 31), the layers which freeze out are simply tin saturated with bismuth. That this is the natural course of events we see on trying to imagine the only alternative which suggests itself, *viz.*, that the layers consist of distinct flakes of such saturated bismuth-bearing tin, and other distinct flakes of bismuth either pure or stanniferous.

That such a mixture of solid flakes of saturated bismuth-bearing tin and other solid flakes of bismuth should arise in case the layers deposited contained more bismuth than their tin was capable of dissolving or retaining dissolved, might easily be conceived. For a given flake finding itself becoming supersaturated with bismuth as it is in the act of solidifying, would expel this excess, and we can conceive that the effect of this expulsion would be that this flake would break up into (1) a little flakelet of tin just saturated with N per cent of bismuth, and (2) a very little flake-

let of bismuth (which as we shall soon see would be just saturated with tin). But even if we form this conception, we see that the natural course of events would be that such bismuth flakelets should immediately redissolve, for the same reason as in the case of salt-water and lead-tin (§§ 21, p. 26; and 49, p. 62), *viz.*, that their reëntry into the mother-metal would leave it fusible at the existing temperature.

The remelting and reëntry of such flakes into the mother-metal should not be opposed by even the mild force which we saw in the silver-gold alloys (§ 54, p. 65) should oppose complete remelting, because in our present case the reëntry of the whole of the flake would still leave the mother-metal fusible at the existing temperature; whereas in the silver-gold alloys the reëntry of the whole flake would make the mother-metal infusible. In the silver-gold case we saw that there should be a struggle between the tendency of the silver to remelt and enter the still molten mother-metal on one hand, and the bond between the silver and gold of the flake which should oppose this removal of the silver from the embrace of the gold on the other hand; and we further saw that this struggle might well result in a compromise, so that part of the silver should remelt and part remain frozen. But in our present case the reëntry of the whole flake of stanniferous bismuth into the molten mother-metal would not render that mother-metal infusible at the existing temperature, so that we should expect the flake to remelt as a whole, and therefore without encountering any opposition from even the mild force which holds together its bismuth and its tin.

67. FREEZING-POINT CURVE OF SUCH ALLOYS. — The freezing-point curve of these alloys of metals of limited mutual solubility is of the family shown in Fig. 33. Here, as in Figs. 24 and 27 we have the V-shaped branches and the horizontal or eutectic line underscoring the V, and the meaning of each is the same as before. But the fact that when but a small quantity of the solute metal is present, *i. e.*, when the excess-metal is in great excess, no eutectic forms, in short that the series is eutectiferous in the middle but not at the ends, is reflected by the fact that the eutectic line aBc does not extend completely across the diagram.

68. BOUNDARIES OF THE EUTECTIFEROUS RANGE. — The ordinates passing through a and c are the boundaries of the eutectiferous range. Any given bismuth-tin alloy containing less than

a per cent of bismuth will, when its solidification is complete, be simply a solid solution of bismuth in tin; any with more than c per cent of bismuth will be a solid solution of tin in bismuth; but any containing between a and c per cent will be eutectiferous. If it is between a and B , *i. e.*, if tin is the solvent or excess and bismuth the dissolved metal, the alloy will be a conglomerate consisting first of bismuth-bearing tin, *i. e.*, of a solid solution of

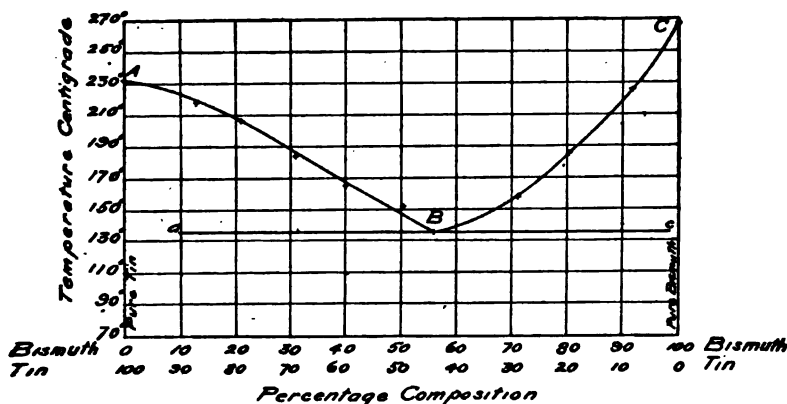

Fig. 33. Freezing-point Curve of the Bismuth-tin Alloys.

(A. W. Kapp, *Annalen der Physik*, 4th Ser., VI, pp. 754-773, 1901.)

In a series of direct experiments in which chemically pure bismuth and tin were melted in various proportions in magnesia crucibles under cyanide of potassium I determined the apparent boundaries of the eutectiferous range as between 9.5 and 10 per cent of bismuth at the tin end and between 1 and 1.5 per cent of tin at the bismuth end. That is to say with the larger percentage in each case a minute quantity of eutectic was visible under the microscope, but with the smaller percentage none could be seen. The structure was developed in each case by etching with dilute nitric acid. The manipulations of the fusions, *etc.*, were performed by Mr. Irving C. Bull. The boundaries given in Fig. 33 are those thus found, and are not given by Kapp.

The results agree substantially with unpublished ones obtained by William Campbell, Esq.

bismuth in tin, formed during the excess-freezing period; and second of the eutectic; if it contains between B and c per cent of bismuth, it will be a conglomerate consisting first of a solid solution of tin in bismuth, and second of the eutectic.

69. MEANING AND GENERAL CONDITIONS OF EQUILIBRIUM.

— Our next inquiry should be as to the nature of the two compo-

nents of the eutectic, still considering the case of bismuth-bearing tin to fix our ideas. In § 65, p. 73, we have already seen reason to suppose that the tin flakes in this eutectic ought to be saturated with bismuth; our next question is as to whether the flakes of bismuth which accompany it should or should not be saturated with tin. But before attempting to answer this question it will be well to consider the general conditions of equilibrium for such cases.

But what do we mean by equilibrium? We here mean first that no metal is supersaturated with another, for so long as such supersaturation exists the supersaturated metal tends to expel from itself the excess of the metal which is dissolved in it; and as long as any such tendency remains unfulfilled and urgent to fulfil itself, equilibrium does not exist. Equilibrium, in this regard, then, means the absence or complete effacement of any such tendency.

We mean, second, that no tendency to diffusion exists. If we put a layer of wine upon a layer of water, each tends to diffuse into the other. Just as connecting bodies of water always seek to reduce themselves to a common level, so the wine and the water tend ever to reduce themselves to a common composition, uniform throughout the mass, by means of diffusion. If there is more wine in part of the mass than in another, this excess tends to spread itself out into the poorer parts exactly as the crest of a wave tends to flatten itself down and fill the trough. Let us recognize clearly this fundamental principle of diffusion. Just as equilibrium is not reached until crests and troughs are both completely obliterated, and the surface of the water is a dead level, so in case of our wine and water, equilibrium is not reached until the tendency to diffusion has completely effaced itself, *i. e.*, until the wine and the water have become one single liquid, homogeneous throughout. In the same way, if we put solid pure gold against solid pure silver, each tends to diffuse into and to dissolve in the other in the form of a solid solution. At the room-temperature this tendency is obeyed only very sluggishly; but as the temperature rises towards the melting-point and the molecular mobility increases, so does the rate of diffusion. And, as we are now considering chiefly the tendencies in alloys shortly below their melting-points, this tendency to diffusion is an important one. It is one of the things which governs the way in which the two metals in the solid alloy

group themselves together, whether into saturated or unsaturated or supersaturated solutions of one in the other.

So long as any relic of this tendency to diffusion remains, urgent to fulfil itself, equilibrium cannot exist. It is arrived at only when this tendency has completely effaced itself by the complete diffusion of the gold and the silver into each other, so that the whole mass has become a perfectly uniform solid solution of one metal in the other.

By *equilibrium* we here mean the complete absence of any unbalanced tendency to change through diffusion.

The cases which we have just considered are simple, because the wine and the water are soluble without limit in each other, and so are the gold and silver in each other. Having by these illustrations shown what we mean by equilibrium, our next task is to see what the corresponding conditions for equilibrium are for two metals like bismuth and tin, which are soluble in each other only within certain limits.

70. EQUILIBRIUM IN A SOLID BINARY ALLOY, IF THE RECIPROCAL SOLUBILITY OF THE COMPONENT METALS IS LIMITED. GENERAL ASSUMPTIONS. — In order to fix our ideas in this discussion let us assume the case of two metals, *A* and *B*, each capable at the temperature under consideration of dissolving 25 per cent of the other. Under these conditions, for the different possible ranges of composition, the constitution of any given lot of an alloy of these two metals, if that lot is uniform throughout, will be as follows:

TABLE I

No.	METAL <i>A</i> , Per cent	METAL <i>B</i> , Per cent	CONSTITUTION
1	0 to 24.9	100 to 75.1	Unsaturated solution of <i>A</i> in <i>B</i>
2	25	75	Saturated solution of <i>A</i> in <i>B</i>
3	25.1 to 74.9	74.9 to 25.1	To be determined by our present enquiry.
4	75	25	Saturated solution of <i>B</i> in <i>A</i>
5	75.1 to 100	24.9 to 0	Unsaturated solution of <i>B</i> in <i>A</i>

Let us further assume that the molecular weight of these two metals is alike. Let us consider first in § 71, p. 78 the case (1 and 2 in Table I), in which there is enough of metal *B* present

in the whole alloy to dissolve the whole of metal *A* which is present, if only metal *B* could get at metal *A* to dissolve it, *i. e.*, that the alloy as a whole contains not more than 25 per cent of metal *A*, and hence not less than 75 per cent of metal *B*.

Clearly what would be true of this case would be equally true, *mutatis mutandis*, with alloys containing not more than 25 per cent of metal *B* and not less than 75 per cent of metal *A* (4 and 5 in Table 1).

Let us then, in § 72, p. 79, go on to consider No. 3 of Table 1, the case in which there is more of metal *B* present in the whole alloy than the whole of metal *A* could dissolve even if it could get at it, and at the same time more of metal *A* than the whole of metal *B* present could dissolve even if it could get at it. The former feature implies that there is more than 25 per cent of metal *B*, the latter that there is more than 25 per cent of metal *A*; in short that there is of each metal somewhere between 25 and 75 per cent. What is true of any one percentage within this range must be true of every other, *mutatis mutandis*.

71. CASES 1 AND 2, METAL *B* IS THEORETICALLY CAPABLE OF DISSOLVING THE WHOLE OF METAL *A* PRESENT, WHEN BOTH ARE SOLID. — The condition for equilibrium in this case is that the whole of one metal should dissolve in the other to form a homogeneous solid solution. To any to whom this proposition is not self-evident, the following cases will probably make it clear.

On one hand, if the two metals did form such a homogeneous solid solution, whether saturated or not, no tendency to diffusion is conceivable. Hence equilibrium would exist.

On the other hand, if they formed a heterogeneous solid solution, diffusion would tend to efface this heterogeneousness, and the excess present in the richer parts would tend to diffuse out into the poorer parts, exactly as water tends to seek a common level, and because this unsatisfied tendency existed, equilibrium could not exist. It would not be reached until the mass through diffusion became homogeneous, and this would be true whether the initial heterogeneous solution was unsaturated throughout, or whether part of it was saturated and part unsaturated.

That this latter would be true is evident on the least reflection. Surely, if a lump of salt is immersed in an unsaturated solution of salt in water, this salt will dissolve and hence will diffuse into the surrounding unsaturated solution. Clearly, too, if we set a

layer of pure water upon a layer of water saturated with salt, the salt of the latter will diffuse into the water. And if it would thus diffuse into pure water, it would for the same reason diffuse into water containing salt, but unsaturated with salt. And if in such a case this tendency to diffusion would thus assert itself, it would exist and would tend to assert itself between adjacent parts of an alloy of two metals, if one of those parts was saturated and the other unsaturated. And as long as such tendency remained, equilibrium would not exist.

Let us then recognize clearly that an unsaturated solution of any metal *A* in any other metal *B* cannot be in equilibrium with a saturated solution of that metal *A* in that metal *B*; for instance that saturated and unsaturated bismuth-bearing tin cannot be in equilibrium with each other, for part of the bismuth of the saturated tin would tend to diffuse out into the unsaturated tin.

72. CASE 3, THERE IS MORE OF EACH METAL PRESENT THAN THE OTHER METAL IS THEORETICALLY CAPABLE OF DISSOLVING. — The condition for equilibrium in this case is that the alloy breaks up into a mechanical mixture or conglomerate of distinct particles, of which some are a saturated solution of metal *A* in metal *B*, and the others are a saturated solution of *B* in *A*. Under the present assumptions that the solubility of these two metals in each other is the same, if the alloy as a whole contains just 50 per cent of each metal, then it will consist of a mixture of equal parts of (1) metal *A* saturated with metal *B*, and (2) metal *B* saturated with metal *A*.

If, however, the alloy as a whole contains only very little more of metal *A* than metal *B* can dissolve, so that it comes near to case 2 of Table I, then this small excess of metal *A* will give rise to only a small quantity of *A* saturated with *B*, and the greater part of the conglomerate will be particles of *B* saturated with *A*.

In order to satisfy ourselves that the law stated in the first sentence of the present section is true, let us first assume in § 73, p. 80 that the two metals in the alloy do distribute themselves in this way, and see whether this arrangement promises to be stable, *i. e.*, that of equilibrium. Let us then assume that they distribute themselves in some other way, and inquire in turn whether this arrangement is that of equilibrium. And, for simplicity, let us throughout this discussion assume that the alloy

as a whole contains 50 per cent of each metal and that as before each is theoretically capable of dissolving 25 per cent of the other.

73. IF THE TWO SOLUTIONS ARE SATURATED, THE SYSTEM IS IN EQUILIBRIUM. — For simplicity let us assume that we are dealing with an extremely minute quantity of our alloy, only 200 molecules, all told; that there are 100 molecules of metal *A* and 100 of metal *B*; and that these actually have grouped themselves in two masses, each a saturated solution of one metal in the other. Our constitution then would be

Grouping 1

	MASS 1	MASS 2
Per cent. of <i>A</i>	75	25
Per cent. of <i>B</i>	25	75
	100	100

In mass 1, *A* is the solvent and *B* the dissolved or solute metal; in mass 2, *B* is the solvent and *A* the dissolved metal.

Clearly no entry of the solvent or excess-metal from one mass into the other can occur, as we see on trying to suppose that it did occur. Suppose that from mass 1, 5 molecules of metal *A* transferred themselves to mass 2. This would leave in mass 1 $70 \times 100 \div (70 + 25) = 73.68$ per cent of *A*, and $25 \times 100 \div (70 + 25) = 26.32$ per cent of *B*; this condition is not of equilibrium, because it would supersaturate *A* with *B*, of which by assumption § 70, p. 77, 25 per cent suffices to saturate *A*. At the same time mass 2 would have been supersaturated with *A*, for it would contain $30 \times 100 \div (30 + 75) = 28.57$ per cent of *A*. This supersaturation is a second element of instability or a second case of lack of equilibrium. So neither mass would be in equilibrium.

Let us now suppose that instead of the solvent metal *A*, it is the dissolved or solute metal *B*, which changes from mass 1 to mass 2, and that 5 molecules of it thus transfer themselves. In this case the two masses will contain:

Grouping 2

	MASS 1	MASS 2
Per cent of <i>A</i>	$\frac{75 \times 100}{75 + 20} = 78.95$	$\frac{25 \times 100}{80 + 25} = 23.81$
Per cent of <i>B</i>	$\frac{20 \times 100}{75 + 20} = 21.05$	$\frac{60 \times 100}{80 + 25} = 76.19$
	100.00	100.00

In this case mass 1 consists of metal *A* unsaturated with metal *B*, and mass 2 consists of metal *B* unsaturated with metal *A*, because each contains less than 25 per cent, the saturation limit, of the dissolved metal. But this is not a condition of equilibrium, as we shall now see.

For if we had molten pure metal *A* and molten pure metal *B* in contact with each other, we should certainly expect each to diffuse into the other, and to continue diffusing until one or the other was saturated, or until diffusion and union were complete. Now for exactly this same reason, since each of these two masses in grouping 2 consists of a given metal unsaturated with the other, mass 1 containing more *A* than the *B* in it saturates or satisfies, and mass 2 containing more *B* than its *A* saturates, we should naturally expect the unsaturated or unsatisfied excess of *A* in 1 to diffuse across into 2, and the excess of *B* in 2 to diffuse across into 1. We should expect that this would go on until saturation was reached, which would clearly be when our original condition of grouping 1 was reached, that is, when mass 1 contained 75 per cent of *A* and 25 of *B*, and mass 2 contained 25 per cent of *A* and 75 of *B*.

In short, the ratio 75:25 in each mass is the only one to be expected, (1) because a lower ratio implies supersaturation, and (2) because a higher ratio ought to lead to diffusion of the excess or unsatisfied part of the solvent or 75 per cent metal of each mass into the other, until the 75:25 ratio was reached.

The change by diffusion from grouping 2 to grouping 1, so as to saturate each metal with the other, was easy to understand because each metal was assumed to be initially unsaturated, so that transfer in both directions could take place simultaneously. Suppose, however, that our 100 molecules of each metal grouped themselves initially in three separate masses as follows:

Grouping 3

	MASS 1		MASS 2		MASS 3	
	Molecules	Per cent	Molecules	Per cent	Molecules	Per cent
Metal <i>A</i>	90	75	10	25	0	0
Metal <i>B</i>	30	25	30	75	40	100
		100		100		100

But the grouping is evidently not that of equilibrium. Clearly the first thing which would happen would be that masses 2 and 3 would unite by diffusion, and our two masses then would be

Grouping 4

	MASS 1		MASS 2	
	Molecules	Per cent	Molecules	Per cent
Metal <i>A</i>	90	75	10	12.5
Metal <i>B</i>	30	25	30 + 40 = 70	87.5

This instability of masses 2 and 3 of grouping 3 in presence of each other clearly follows from the general law which we saw in § 71, p. 78, that a saturated and unsaturated solution of any metal *A* in another metal *B* cannot be in equilibrium.

When we come to study the phase rule, we shall further see that the instability of grouping 3 is simply an instance of the general law, that no system containing only two constituents (in this case two chemical elements) can be in equilibrium (except at a single temperature) if it has more than two "phases," *i. e.*, distinct kinds of masses or entities, in this case two distinct solutions and one free element.

Having thus seen that grouping 3 is not that of equilibrium, and tends to change over into grouping 4, let us next enquire whether this latter in turn is that of equilibrium or not.

Of the 70 molecules of *B* in mass 2, only 30 are saturated or satisfied by the 10 molecules of *A* in it; the remaining 40 molecules of *B* are unsaturated or unsatisfied. But the very fact that in this grouping 4 the solvent power of *B* remains unsatisfied, whereas in grouping 1 the solvent power of each metal is fully satisfied, shows

that 1 is the condition of greater stability, of equilibrium; this is the condition which would naturally be reached, and that into which grouping 4 or indeed any other grouping would tend to resolve itself, by diffusion. In case of grouping 4, 15 molecules of metal *A* and 5 of metal *B* would tend to transfer themselves from mass 1 to mass 2, thus giving the equilibrium grouping 1.

Thus grouping 4 also is not that of equilibrium, and would tend to resolve itself into grouping 1.

We have thus seen that, whereas grouping 1, of complete reciprocal saturation, is that of equilibrium, these other groupings, 2, 3 and 4, are not; and what has been thus found true of these would be found by like reasoning to be true of any grouping other than 1.

For the particular conditions which we have assumed, then, (1) the presence of 100 molecules of each metal, and (2) that each can dissolve 25 per cent of the other, we have found that reciprocal saturation of the two metals by each other is the condition of equilibrium. But what has thus been found true for these assumptions, made merely to fix our ideas, would by like reasoning be found true of any other set of assumptions, *mutatis mutandis*.

In short, if there is more of each metal than suffices to saturate the other, the condition of equilibrium is that of a mechanical mixture of particles of the two metals, each saturated with the other; in other words, that of a pair of saturated solutions. Manifestly this is as true of the molten as of the solid state; though in the molten state, because of greater molecular freedom, the condition of equilibrium would be more quickly reached.

Such a mechanical mixture of two alloys, especially of two molten alloys, tends naturally to become less and less intimate, as the particles of each alloy gradually coalesce into larger and larger masses; and eventually they should separate from each other by gravity into two distinct layers, the lighter alloy floating upon the heavier. Be it understood that, when a mechanical mixture is spoken of as the normal condition, it is meant to include also this state of affairs in which the two alloys separate into two distinct layers, though it is admitted that "mixture" is rather an unfortunate term to apply to two distinct superposed layers. It is the end condition, to which the class name applies only by a stretch, such as we use when we say that a mathematical point is a circle of infinitesimal radius, and that a straight line is part of the arc of a circle of infinite radius.

74. THE CONSTITUENTS OF THE EUTECTIC SHOULD BE SATURATED WITH EACH OTHER. — Let us now return to our study of the constitution of the eutectic which forms in the freezing of any bismuth-bearing tin, the bismuth-content of which is large enough to lead to the formation of a eutectic as explained in §§ 64 and 65, pp. 72 and 73:

We have already seen that this eutectic should be composed of sheets of tin saturated with bismuth, and other sheets of bismuth. The question now before us is whether those sheets of bismuth should in turn be saturated with tin. They should, for the reason that this eutectic falls into the class discussed in §§ 72 and 73, pp. 79 and 80, of alloys containing more of each metal than the other can dissolve. For we have seen that it contains as a whole more bismuth than the tin can dissolve, and we may admit that it also contains more tin as a whole than the bismuth in it could dissolve were it able to get at all that tin; for if not, there would have been no reason why, in freezing, it should split up at all. If the bismuth in the mother-metal at the time when it reached the eutectic composition and freezing-point were able to retain in solution after freezing the whole of the tin then in that mother-metal, it should so retain it, and the eutectic should remain as a single solution of tin in bismuth, instead of breaking up into a conglomerate.

Because, then, this eutectic contains more of each metal than the other can dissolve when solid, the flakes of each metal should be saturated with the other. In short, it should be a conglomerate of saturated solutions of the two metals in each other. This would be the state of equilibrium; and, owing to the conditions of the birth of the eutectic, we should expect the approximation to that state to be extremely close. For in the facts (1) that in the molten mother-metal at the time when it freezes into the eutectic the two component metals are presumably distributed with absolute uniformity, are in contact molecule with molecule, and (2) that in the passage from the molten to the solid state the high degree of fluidity should cause great ease and freedom of molecular motion, we seem to have just the conditions which should make these molecules group themselves in very close approximation to the stable condition of equilibrium, and break away from any other and unstable condition, should any such be momentarily entered into.

75. THE STRUCTURE TO BE EXPECTED FROM THESE CONDITIONS IN A EUTECTIFEROUS ALLOY. — Still considering the case of bismuth-bearing tin to fix our ideas, let us for simplicity first assume that the successive layers which freeze out from the molten mass deposit themselves along the smooth walls of the enclosing vessel or mould, in perfectly smooth and parallel layers, like the successive peels of an onion, save that they are extremely thin, of a thinness approaching that of a molecule. Let us further neglect gravitation and the contraction due to cooling, and let us assume that the alloy is contained in a cubical mould, and that the rate at which the heat escapes from the surface of the mould is the same



Fig. 34. The "Onion" Type of Freezing.

for all six sides of this cube, and hence that the rate of freezing and deposition of solid metal on all six sides is alike. Let us call this the onion type of freezing.

In this case the structure of the frozen ingot of our alloy should be that shown in Fig. 34. The outer part, marked 1, is the unsaturated bismuth-bearing tin, deposited during the subsaturation period of the selective freezing and corresponding to the part BB' of Fig. 31; part 2 is the saturated bismuth-bearing tin deposited during the saturation period of the selective freezing, and corresponding to part $B'C$ of Fig. 31; part 3 is the last frozen part, the conglomerate eutectic, corresponding to part CD of Fig. 31.

76. SEGREGATION.—This heterogeneousness of frozen alloys is recognized in metallurgical manufacture under the name of segregation. Fig. 35 shows how the carbon in a large ingot of gun-steel has thus segregated. In this case the segregation is found in the upper part of the axis of the ingot, because that is the last part of the mass to solidify. This in turn is due chiefly (1) to the fact that the bottom of the ingot is in contact with the cast iron

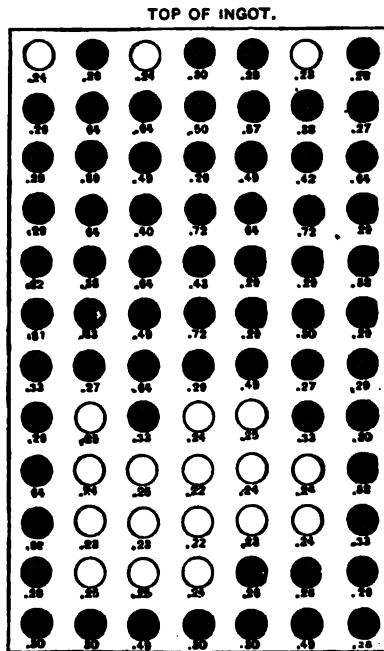

Fig. 35. Percentage of Carbon at Different Points in the Vertical Section of a Large Ingot.

Maitland, "The Treatment of Gun-steel," Excerpt *Proc. Inst. Civ. Eng.*, LXXXIX., p. 12, 1887. The depth of shading of the spots is roughly proportional to the proportion of carbon.

bottom of the mould which is cold and hence absorbs heat greedily, while the upper surface of the ingot is exposed to the air into which heat escapes relatively slowly; and (2) to the fact that the hotter parts of the molten metal because lighter rise to the top, while the cooler ones, the temperature of which is sinking close to the freezing-point, sink to the bottom. Because the eutec-

tic is the most fusible and hence the last freezing part of the whole, so we expect to find it in the last frozen region wherever that may be. And for like reasons we expect that the saturated layers, No. 2 of Fig. 34, will surround this eutectic, whether this lies in the centre of the mass or not; and that outside of these saturated layers the unsaturated layers (1 of Fig. 34), will be disposed in general rough symmetry with the eutectic itself.

77. ABNORMAL SEGREGATION. — But, while it seems normal and natural that the segregate, *i. e.*, the mass expelled in the freezing of the earlier layers and found concentrated in the axis of the ingot, should be the most fusible of all the constituents which form in freezing, and that it should have a larger percentage of the dissolved or solute metal, or of the impurity if we may so call it, than the molten alloy as a whole did, yet this is not always the case. Thus in ingots of cupriferous silver the segregate, instead of being richer than the earlier frozen parts in copper, which is the dissolved or solute metal or the impurity, are actually richer in silver; * so that the segregate, which certainly appears from its position to be the last frozen part, is actually of a composition which should make it more infusible than the earlier frozen parts. Thus, in short, it here appears that the parts first to freeze are really more fusible than those last to freeze. And the same seems to be true of some other alloys.

The explanation of this phenomenon does not seem clear. Convection currents, and gravity stratification of the nascent solid constituents in the act of freezing, may contribute; but they do not seem at first sight to be in and by themselves a sufficient cause. Another explanation, somewhat more complex yet more cogent, is that, although in the act of freezing proper the first frozen parts were more infusible than the last frozen, or in short although the order of deposition in freezing was normal; yet in the slow cooling which followed freezing the silver migrated centreward, coalescing somewhat as drops of water suspended in oil tend to draw together and coalesce. That is to say, after the eutectic had frozen, there were present particles of saturated argentiferous copper and other particles of cupriferous silver. The isolated particles of each may have tended to migrate centreward

* W. Chandler Roberts (Roberts-Austen), *Proc. Roy. Soc.*, 23, p. 490, Figs. 1 and 3, 1875.

so as to coalesce with their kin, but both could not do this simultaneously; hence a competition between silver and copper; and in this competition the silver may have conquered or outstripped the copper.

For simplicity, and to follow out what seems to be the normal type of segregation, we will, in the remainder of this discussion, ignore this other and abnormal type.

78. MODIFICATIONS OF THIS STRUCTURE. — When we come to examine our alloys under the microscope we find a condition

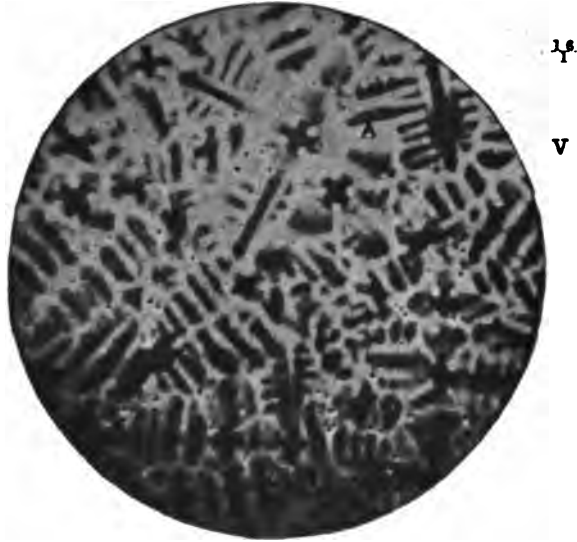
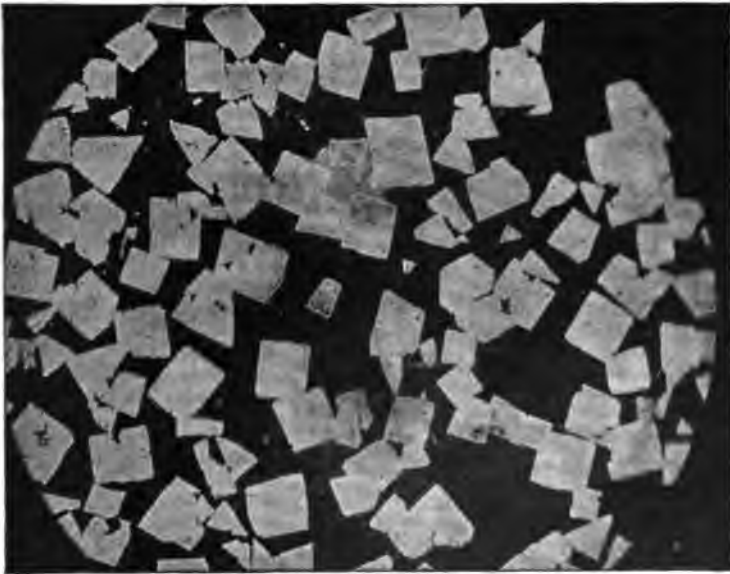

Fig. 36. Alloy of 97.1 per cent Copper, 2.9 per cent Aluminium showing Heterogeneous of Solid Solution.

(Wm. Campbell, private communication.)

of affairs which, as shown in Figs. 17, 18, 19 and 36, differs markedly from the type sketched in Fig. 34. Instead of a deposition of successive layers, of which each is the smooth surface of a cube concentric with the mould, *i. e.*, with the outer surface of the whole mass, we find indications rather of a growth like moss or like miniature pine-trees, a growth along spines and shoots instead of in smooth layers; a growth which, before freezing is complete, must shut in and, to change the simile, landlock part

of the still molten mass, isolating it from the rest of the molten metal. The shape of the individual pine-trees may vary greatly with the composition of the mass, and perhaps with the attendant conditions of freezing. The branches may be extended as indicated in Fig. 42, p. 96, or rudimentary like those which start to branch out horizontally from the lower part of the great crystal shown in Fig. 5, p. 6. Again, the growth may take place through other forms, such as the cubes (Fig. 37) in which antimonide of tin, SnSb ,



33

V

Fig. 37. Alloy of 80 per cent Tin, 20 per cent Antimony.

Showing the Isolation of the Cubes of Tin-antimonide, SnSb ; Horizontal Section of the Ingot, 33 Diameters. Vertical illumination.

Prepared by William Campbell in the Author's Laboratory.

grows. In case the cooling is very slow, this growth may occur around little nuclei which are either actual islands, *i. e.*, actually wholly detached from the already frozen continent, or at least are held to it by such a slight bond that their buoyancy suffices to break this bond and thus to enable them to swim to the surface. (Compare § 37, last paragraph, p. 45.) In either of these cases the growth and final broadening of adjacent pine-trees until they

absorb all the metal and space between them, would result readily in the columnar structure shown in Fig. 3, p. 5.

Still another form is shown in Fig. 38. These are thin sheets, apparently of the iron carbide Fe_3C , called cementite, shooting across a cavity or vug in an ingot of ferromanganese. These plates may reach a great size, as is shown in Fig. 39. Here the great facets of the block of ferromanganese seem to be due to the fact that, when the mass was broken open, rupture traveled



Fig. 38. Sheets Apparently of Cementite, Fe_3C , in Ferromanganese.
The Author's Collection.

along the faces of certain of these great plates of cementite, which act as cleavage planes. Fig. 40, p. 92, again shows a micrograph of cast iron containing pronounced sheets of this cementite.

DEFINITIONS. — To facilitate the present discussion of the phenomena of progressive freezing, let us adopt provisionally the following terms.

The Frozen Continent means the part of the alloy which, at any given instant under consideration, has already frozen.

By the Shore Layers I mean those layers which have already in part solidified, and yet in part remain unfrozen, with poollets or estuaries of still molten matter, or in other words the layers in which freezing is actually going on.

By the Littoral Region I mean that part of the still unfrozen alloy immediately adjoining the shore layers; in other words, the layers which have not yet actually begun freezing but are about to.



Fig. 39. Block of Ferromanganese with Large Facets Formed by Cementite Sheets. The Author's Collection.

The Open Sea means the still unfrozen mother-metal, beyond the littoral region.

Fig. 42, p. 96, may make the meaning of these terms clearer.

In the study of the growth of the frozen continent we may, to fix our ideas, confine our attention to some one of the many forms of growth. Let us select the broad armed pine-tree type shown in Fig. 42.

We will now further examine this pine-tree variety of the shoot-growth type of deposition as distinguished from the onion

type shown in Fig. 34, p. 85, and we will note in particular two features which show that, great as is the apparent difference between the two modes, they really have much in common. These two features are, 1st, that although the deposition proceeds along certain spines chiefly, yet it is nevertheless a deposition in layers; 2nd, that though these spines enclose and as it were landlock part of the mother-metal remaining molten at the time when they shoot out, nevertheless much of it remains unlocked, and free to migrate, so that in fact much segregation occurs.

79. THE DEPOSITION IS IN LAYERS, THOUGH IN DISTORTED ONES. — When we come to reflect upon the structure shown in



Fig. 40. Cast Iron Showing Plates of Cementite and Eutectic.
Section parallel to cooling surface.

(Tiemann, in the Author's Laboratory, *The Metallographist*, IV, p. 322.)

Fig. 36, p. 88, we infer that, though the deposition takes place chiefly along branches and spines, yet it is a deposition of successive layers on them. This is indicated in the space just below letter *A*, where the tint shades off very gradually. This, then, is a deposition by layers, differing from the layers of the onion type of Fig. 34 in the fact that, whereas the latter are smooth continuous concentric cube-surfaces, in the type shown in Fig. 36 these layers, while remaining parallel with each other, yet may collectively change direction abruptly, with sharp reëntering angles where they pass the crotch of a bough or spine, and salient ones where

they pass around an apex. They may be like the parallel though plicated sheets of a distorted bed of schist, or the pages of a crumpled pamphlet.

These similes, indeed, suggest that the rate of deposition is the same on the spines and twigs as on the boughs of our pine-tree structure, which may or may not be the case. It is more probable that the rate of deposition along certain surfaces is more rapid than along others, as if the boughs of a pine-tree were to increase in thickness rapidly, while the increase in thickness of the twigs was much slower, and that of the spines very much slower still. Such a condition of affairs seems to exist in the space just below the letter *A* in Fig. 36; for while the tint shades off very gradually, downwards from the upper side of this space, and upwards from the lower side, we do not find such shading from the right and left sides; as if the growth had taken place from the top and bottom of this space and not from the sides.

80. LANDLOCKING TYPE OF DEPOSITION. — If we were to push to its logical conclusion this idea of growth by shoots instead of by concentric hollow-cube layers, we might conceive that such a cubical mass of molten alloy as is shown in Fig. 34 was, by such shoot-growth, cut up in the beginning of the freezing into a series of cubelets, each completely insulated from its neighbors by these shoots. Such a condition of affairs is shown diagrammatically in Fig. 41, p. 95, the whole mass being thus cut up into twenty-seven insulated landlocked cubelets, of which nine appear in our section. It is not to be supposed that in any actual case such complete subdivision and insulation could thus occur at the very beginning of the freezing as here sketched. If it occurred it should be later, when through the gradual thickening of such shoots they had come to insulate certain still molten parts from the main mass of the still molten interior, and as it were to “landlock” certain pools of the molten alloy, insulating them from what we may call the still molten open sea — open in the sense that in the interior of the cube beneath its frozen top it extends from frozen shore to frozen shore. We may call it open in spite of the fact that it is supposed to be frozen over at its upper surface quite as much as at its bottom and sides.

Nevertheless, the condition shown in Fig. 41 may be taken as the extreme type towards which this landlocking mode of freezing tends, and for convenience we may call it the “land-

locking type" to distinguish it from the other extreme, the "onion type."

Assuming that, once this landlocking has taken place the freezing henceforth occurs in parallel layers, after the whole has frozen each cubelet will present the same series of regions that the cube in Fig. 34 shows, (1) the outer unsaturated layers; (2) the saturated ones; and (3) the eutectic.

Of course, the causes which led to this subdivision of the whole cube into these twenty-seven cubelets, should in fact be expected to lead to the further subdivision of these in turn into still smaller ones, and of these again into still smaller, until at last the mass is thus divided up into the microscopic enclosures which Fig. 36, p. 88, shows us.

Now in each of these microscopic enclosures the same series of events should happen which would take place if freezing occurred as shown in Fig. 34. In each microscopic cube we should find the same series of deposits, (1) the first deposited unsaturated layers, (2) the saturated layers, and (3) the eutectic. This differentiation of our microscopic cubelet thus should yield what we may call microscopic segregation, such as we see not only in Fig. 36, but also in Figs. 17, 18, 20 and 21 to 23. In each of these we find this microscopic segregation. In all except Fig. 36 we see the segregation of the eutectic as a microscopic mass, surrounded by the earlier frozen excess-substance. In Fig. 36 we do not recognize the eutectic structure, but we find clearly marked the unsaturated layers, still showing the remains of their initial heterogeneity. For instance, in the space just below letter *A* the dark and white parts shade off by imperceptible gradations into each other, as already pointed out.

81. SEGREGATION IS BOTH MICROSCOPIC AND MACROSCOPIC. — Up to this point we have imagined two distinct types of freezing. In the first or "onion" type, shown in Fig. 34, the mass in freezing acts as one whole, so that the mother-metal is neither crossed nor intruded into by any shoots as freezing proceeds, but remains throughout a single open, smooth-shored and smooth-bottomed sea, the shores, sides and bottom of which form a single cube, at each instant concentric with the walls of the ingot-mould. Here each layer as it deposits is the surface of a continuous cube extending completely around the shores, sides and bottom of this open sea, which is thus gradually silted up by the deposition of this

series of layers, each concentric with the initial shape of the sea itself. Thus our sea retains not only its initial shape but its initial centre, until by complete silting up it finally disappears.

In the second or "landlocking" type, shown diagrammatically in Fig. 41 and illustrated by Fig. 36, this sea is broken up at the very beginning of freezing into a number of pools, each completely landlocked by the growth from shore to shore of dividing barriers, and each pool is thus completely isolated from its neighbors. In each of these pools freezing proceeds as in the first type, and

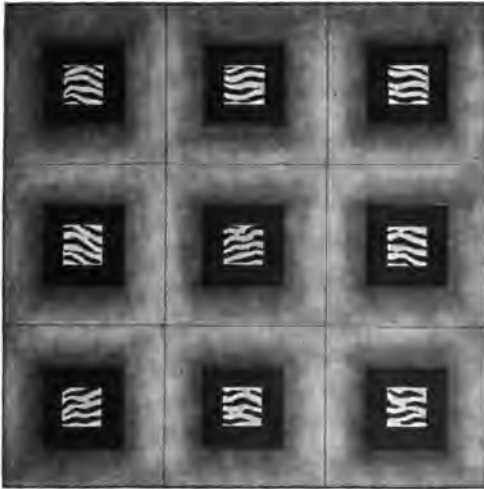

Fig. 41. The "Landlocking" Type of Freezing.

from the subdivision of these pools into microscopic poollets, microscopic segregation results.

Let us now recognize that freezing actually is of both these types simultaneously. There is the gradual silting up of our sea by the deposition of concentric layers, and there is also landlocking, due to the fact that these concentric layers are themselves not smooth sheets but mossy strata. The silting up of our sea is not by the deposition of impalpable mud in thin smooth layers on sides and bottom, but by the growth of a moss-like or peat-like mass, a thin forest of minute pine-trees. At any given instant the mass as a whole consists (1) of the already frozen outer con-

tincent, (2) of the shore layers now in the act of depositing, and (3) of the still open central sea including the littoral region. But the shore layer is itself composite somewhat as shown in Fig. 42. At its inner face the summits *A* of its little pine-trees project out into the still open central sea; at its outer face their thickened trunks and branches mat themselves close together, completely filling up the interstices; the mass is solid, as at *B*. Between summit and base is a series first of bays *C*, then of well-protected



Fig. 42. The Shore Layers and the Littoral Region.

havens *D*, then of harbors *E*, the mouths of which are badly obstructed by bars, and finally of completely landlocked basins *F*.

In each of these landlocked basins freezing proceeds selectively as in other cases. First layers are deposited poorer in bismuth* than this mother-basin or pool from which they freeze, the pool of which they form the progressively encroaching shores. As freezing progresses the successive layers of shore deposited are

* We are still considering the case of bismuth-bearing tin.

richer and richer in bismuth, till at the final disappearance of the pool the last frozen particle is richer than the pool was at the moment when it became landlocked. Thus the drying up or rather freezing up of each of these landlocked pools gives rise to microscopic segregation.

But at the same time macroscopic segregation is going on for exactly the same reason as in the onion type. The only differences between the two cases are (1) that the shore layer is serrated in our present case though smooth in Fig. 34; and (2) that this landlocking takes place. But neither of these differences can prevent the progressive enrichment of the mother-metal, the open sea. The enrichment takes place quite in the same way, whether the layers which freeze out are smooth in outline, or serrated.

Consider for a moment the growth of a single pine-tree *A*, Fig. 42. A very thin layer of metal is deposited upon it; this layer is richer in tin and poorer in bismuth than the open sea from which it freezes; hence by its freezing the immediately adjoining layer of sea is enriched in bismuth; this excess of bismuth diffuses outwards into the open sea, which thus becomes progressively enriched. We may attempt to indicate this by the arrows in Fig. 42. But the enrichment of the open sea which took place through the deposition of this layer will take place with the deposition of each succeeding layer; and thus the open sea or mother-metal becomes gradually enriched as its shores gradually draw together, as its tide slowly falls; and with its enrichment comes the corresponding enrichment of the successively deposited layers, the successively emerging curved lines of the seashore. Manifestly this is just what is shown in Fig. 34, substituting serrated for smooth contours, and substituting layers microscopically segregated and thus each heterogeneous, for layers each homogeneous, though each different from its neighbors, each richer in bismuth than the next older one.

Let us recognize clearly this double heterogeneousness, this double segregation, macroscopic and microscopic; this progressive enrichment of the whole mass as we pass from outside to centre, and also this enrichment, in each individual thin layer, of those parts which were the central regions of the landlocked pools.

82. PROGRESSIVE VARIATION IN THE MICROSCOPIC SEGREGATION. — That as we pass from without inwards the character of

the microscopic segregations should change really follows from what has been said; but a further word of explanation may not be amiss.

We have seen how, with the gradual thickening of the walls of the solid continent which forms the already frozen part of the ingot, the remaining open sea is gradually enriched in bismuth, the dissolved metal. Now at any given moment the composition of each bay shown in Fig. 42 should be very closely that of the open sea; and the composition of the havens and of the partly barred harbors should also follow closely, though not quite so closely, the composition of the open sea. At least their composition should shift with that of the open sea, and in the same direction, though, thanks to the ever increasing barriers, not necessarily at exactly the same rate. Ignoring for the present this difference in rate, the composition of each landlocked basin, at the moment when its last communication with the open sea is frozen across, should be closely that of the open sea; so that the composition of the successive landlocked basins formed in successive layers should, at this moment of the completion of their isolation, vary progressively from layer to layer. Each basin at the moment of its insulation, should be richer in bismuth than the earlier formed basins were at the moment of their insulation.

But it is chiefly the composition of any given basin at this moment of its insulation that will determine in what kind of layers it will deposit as it in turn freezes up. Each basin will hereafter act independently of the rest; it is as if we started with a different initial composition for each. And, just as we saw in § 60, p. 68 that the series of alloys of two metals of limited reciprocal solubility should be eutectiferous in its middle but not at its ends, so of the local segregations arising from the freezing of these basins, some may be eutectiferous, and some not.

Thus, the basins formed in the outer crust of the ingot, early in the freezing, when hardly any enrichment of the open sea has taken place, might have so little of the dissolved metal that the enrichment of the successive layers during freezing would not reach the saturation-point. Such ponds would yield only unsaturated layers. Others, formed somewhat later, when the enrichment of the open sea had gone farther, might at the moment of their insulation contain so much of the dissolved metal that the enrichment of the successively formed layers would pass the sat-

uration-point; in which case, exactly as in § 64, p. 72, not only saturated layers but also some eutectic should form. Still others, later formed, and with a still larger proportion of the dissolved metal, would yield a larger proportion of eutectic; *etc.*

83. APPROACH TOWARDS ONE OR THE OTHER OF THESE TYPES. —While freezing is doubtless always between these two extreme types, the onion and the landlocking, yet we may recognize certain features which should bring it nearer to one type or the other. The earlier the out-shooting pine-trees meet in the centre, the closer should the conditions approach to the extreme landlocking type of Fig. 41, which completely prevents all axial or macroscopic segregation; and the less pronounced should therefore be the axial segregation. And in general the narrower the open sea, *i. e.*, the narrower the mould in which the metal is cast, the earlier will this meeting take place. Further, the farther the arborescent promontories shoot out into the open sea, the earlier will they meet. While we may not forecast fully what kinds of metal will form far-shooting promontories, yet we may expect that those with great thermal conductivity will as a whole shoot out farther than those which conduct heat but slowly; and the viscous ones should shoot out farther than the more mobile, because the convection currents are less in the former, and convection currents may be expected to oppose the shooting out of long-trunked pine-trees by tending to break off their trunks, or to wash them off. It is in still ponds that ice, in forming, shoots out long spines.

Thus we may expect macroscopic segregation to be less (1) in narrow ingots, (2) in viscous metals and in those of high thermal conductivity, than under the opposite conditions.

83A. CONDITIONS AFFECTING THE DEGREE OF RESIDUAL SEGREGATION. — In §§ 84 to 93 we shall consider how the rate of freezing and of cooling from the freezing-point downwards may be expected to influence the degree to which segregation will exist in the cold alloy. This discussion is in the nature of a forecast. A series of investigations has been planned and begun, to test the conclusions reached in this discussion. While it is greatly regretted that these experiments cannot be completed in time to permit the use of their results in the present work, it has been thought best to retain this discussion here, both as a mental exercise for the student, tending to familiarize him with at least cer-

tain important aspects of the subject, and as furnishing a hypothesis susceptible of ready test, and thus likely to serve as a stepping-stone to more thorough knowledge of the subject.

To simplify the discussion it is supposed to be confined to non-eutectiferous alloys, *i. e.*, to those in which no eutectic should be present if equilibrium was reached, or in other words to those in which one of the two metals present is theoretically capable of dissolving the whole of the other.

If equilibrium is not reached, such an alloy may contain a eutectic, which would be absorbed and would thus disappear if diffusion should later perfect itself. (§ 96, p. 113.)

84. DIFFUSION TENDS TO LESSEN THIS SEGREGATION. — This heterogeneous structure of the alloy which we have just been considering, with its three sets of layers, (1) unsaturated and (2) saturated bismuth-bearing tin, and (3) the eutectic, clearly is very far from being a condition of equilibrium. Looking no farther than the initial heterogeneity of the unsaturated layers, this itself is not of equilibrium, for from the later deposited and richer part of these unsaturated layers, part of their bismuth tends to diffuse into the earlier ones which are poorer in bismuth. So too part of the bismuth of the saturated layers tends to diffuse out into the unsaturated ones, so that these which were initially saturated thus tend to become unsaturated. Then into these layers thus become unsaturated, part of the bismuth of the eutectic tends to pass through diffusion. This tendency, therefore, in so far as it is obeyed, will diminish the quantity of eutectic, by causing a regrouping of its constituent metals, somewhat as grouping 3 changed to grouping 4, and this in turn to grouping 1, in § 73, p. 80. If this transfer of bismuth from the eutectic into layers (2) so far impoverishes the eutectic in bismuth that its tin now is theoretically sufficient to dissolve the whole of that bismuth if it could get at it, then, as we saw in § 71, p. 78, it will tend so to dissolve that bismuth through regrouping. And if that tendency is obeyed fully, our conglomerate eutectic will disappear and be replaced by a solid solution of bismuth in tin. Finally this solution may, through further diffusion, eventually become quite uniform in composition throughout, both the microscopic and the macroscopic segregation being thus effaced; and this might eventually happen even if the ingot was initially much segregated, and even if it was several feet thick.

85. **DIFFUSION LESSENS BOTH MICROSCOPIC AND MACROSCOPIC SEGREGATION.** — This leveling tendency of diffusion evidently applies to both the microscopic and the macroscopic segregation. It tends to undo both of them, and to reduce the alloy (1) to a homogeneous solid solution if (as is assumed in the present discussion), the proportion between the total quantity of the two metals present in the whole mass is such that one is theoretically sufficient to dissolve when solid the whole of the other; and (2) to a eutectic plus a saturated homogeneous solid solution, if this proportion is such that neither can dissolve the whole of the other.

86. **HOW COMPLETE IS DIFFUSION?** — Under the conditions usual in manufacture, this tendency clearly is not completely fulfilled. Diffusion does not so perfect itself as regards the macroscopic segregation of large steel ingots, even if their cooling is so slow as to extend over many hours; for these ingots are habitually much segregated, so much so that for certain special purposes, for instance gun-forgings, the segregated axial part of the ingot is cut out and thrown away.

How far diffusion perfects itself as regards microscopic segregation, remains to be investigated. Certainly the gradual shading off of tint shown in Figs. 32 and 36 suggests strongly that much of this initial microscopic heterogeneousness persists in spite of diffusion. But these indications must be received with extreme caution. Even the experienced microscopist must exercise the greatest care in interpreting such appearances; for while this shading off may indeed be due to corresponding heterogeneousness of the alloy, yet it also may be due to the manner of preparing the metallic surface for microscopic examination.

But apart from such indications, we may reasonably hold that the slower the cooling is from the melting-point downwards, the greater should be the opportunity for diffusion, and the less should be the residual segregation.

The reader should here distinguish sharply between this equalizing action of diffusion, which ought to be favored by long exposure to a temperature only slightly below the eutectic freezing-point, and the liquation effect which may be brought about by holding an alloy at a temperature between the upper and lower freezing-points. In this latter range of temperature the alloy as a whole is in part solid, and in part molten; and the molten part

tends to draw together, to coalesce, and under favorable conditions even to liquate and sweat out from the mass of the alloy.

87. FREEZING DIFFERENTIATES, DIFFUSION EQUALIZES. — Let us at once recognize that we have here two agencies, freezing and diffusion, with diametrically opposite tendencies. Freezing is a process of differentiation, tending to split up the alloy into the three sets of components of Fig. 34, p. 85, with which we are now so familiar; diffusion is a process of equalization, tending to efface the heterogeneousness which freezing induces.

Having just seen that the rate of cooling from the freezing-range downwards should be expected to influence the degree of residual segregation, we may now pass on to enquire what influence the rate of cooling through the freezing-range itself ought to have on residual segregation. But at once we must discriminate between two different things going on simultaneously in this range, the differentiation taking place at any given instant in the very particles which are freezing at that instant; and the equalizing action of diffusion in the layers which have frozen prior to this instant. If we hasten the freezing of a given layer, we necessarily hasten also the cooling of the previously frozen layers, and we thereby lessen the opportunity which diffusion has to equalize the composition of those layers.

Let us for the present disregard this latter influence of the rate of cooling through the freezing-range, and confine our attention to the influence of rapid cooling on the differentiation which freezing itself causes.

Then later let us go on to consider other features of this problem, and let us enter our results as we reach them in Table 2, p. 112.

88. RAPID FREEZING SHOULD LESSEN SEGREGATION. — Just as rapid cooling from the freezing-point downwards should restrain the equalizing action of diffusion, so rapid cooling through the freezing-range appears to restrain the differentiation which freezing tends to cause. Thus in Fig. 35, p. 86, we find that the differentiation which the ingot as a whole shows, does not include the outer layers of the ingot. The progressive enrichment of the successive layers in carbon from without inwards does not begin until we have passed a considerable distance inwards from the outer crust.

We may reasonably refer this to a restraint put upon the dif-

ferentiation by the suddenness of the freezing. This suddenness has checked in the outer layers the impoverishment to which differentiation normally leads, with the result that these layers are richer in carbon than they normally would be, if differentiation and impoverishment took their full and natural course.

[The matter between these brackets is to explain the foregoing more fully to any to whom it is not clear.

Let us refresh our memory as to what occurs or tends to occur in freezing. When the first layer freezes, the differentiating tendency causes it to be purer, *i. e.*, to contain less carbon, than the molten metal from which it freezes, so that the freezing of the first layer gives us two bodies, this frozen layer poorer in carbon and the residual mother-metal richer in carbon. The next layer to freeze, however, while again poorer in carbon than the mother-metal which it in turn leaves, should be richer in carbon than the first frozen layer, simply because the mother-metal out of which the second layer freezes is itself richer in carbon than the mother-metal out of which the first layer froze. And so on, each layer at the instant of its birth should be richer in carbon than the layer which froze just before it; and this is a result of differentiation.

Thus this differentiation itself, this very impoverishment of the early frozen layers, leads to the enrichment in carbon of the later frozen ones. This enrichment will be continuous and progressive if differentiation takes place normally, so that after the whole ingot has solidified we should, on analyzing it, find a progressive increase in the percentage of carbon from the first frozen outer layers to the last frozen inner ones.

If some means was discovered by which differentiation could be wholly prevented, then this impoverishment of the early freezing layers would thereby be wholly prevented, and the mass, when frozen throughout, would be uniform in composition. If differentiation was partly restrained, for instance in the first freezing layers, then the impoverishment of these layers would be somewhat restrained, which means that they would be left richer in carbon than they would have been had differentiation and impoverishment had full play without this restraint; or in short they would be abnormally rich in carbon. They would thus be more nearly saturated than they would have been if this impoverishment had had full play, *i. e.*, if they had been impoverished to the normal degree. And if in the outer and first freezing layers impoverishment was

thus prevented, so that they were abnormally rich in carbon, while in the layers freezing somewhat later differentiation and impoverishment were not thus restrained but took place to their full natural extent, then the outer layers might actually be richer in carbon than those inside them.

Now this is exactly what seems to have taken place in the ingot shown in Fig. 35, in its lower part, which is naturally the part to freeze most rapidly, because it is exposed not only to the sides of the cold mould but also to its cold bottom, whereas the upper part of the ingot is not covered with a cold top but is exposed to the air. Moreover, the hotter metal would naturally rise to the top, and thus tend to delay freezing there. Looking at the lower five of the horizontal rows of numbers, we see that in them the outermost layer is richer in carbon than the layer next inside it. Here, then, the progressive enrichment of the successively frozen layers, instead of beginning at the very skin, begins only when a considerable depth within or beneath the skin is reached; the impoverishment of the outer layers then seems to have been interfered with; evidently it has not taken place to its normal extent. Our natural inference is that it is the rapid freezing of this, the fastest freezing part of the shell, which has restrained its impoverishment, *i. e.*, has given it this abnormal richness.]

To say that the skin is abnormally rich in carbon is only another way of saying that the iron here, while of course not saturated with carbon, is more near to saturation than it would have been had differentiation and impoverishment taken place to their normal extent. That this is the true explanation we hold the more confidently from the fact that we have good reason to believe that sudden cooling may go farther and actually leave the frozen metal not simply abnormally near to saturation, but actually supersaturated.

Thus cast iron when molten contains a large quantity of carbon dissolved in it, of which during slow freezing it expels a large part in the form of graphite. But if frozen rapidly it retains dissolved a very large part of this carbon which it would have expelled if the freezing had been slow. This excess is so great as to indicate that the suddenly frozen cast iron is greatly supersaturated with carbon.

We have something similar in the hardening of steel, which of course consists of iron plus carbon. When the steel is above a

certain critical temperature, its iron is in the *Gamma* state, and in this *Gamma* iron the carbon readily dissolves, forming a solid solution. On cooling below a certain critical range the *Gamma* iron changes to *Alpha*, in which the carbon is apparently wholly insoluble, or at most only very slightly soluble. The normal condition of things is that, when the iron thus changes from *Gamma* to *Alpha* the carbon passes out of solution because insoluble, and unites with part of the iron to form the definite carbide Fe_3C , called cementite; so that the steel when cold normally consists of a conglomerate of (1) *Alpha* iron free from carbon, and (2) this cementite; and this is what we find in slowly cooled, *i. e.*, "annealed" steel. But if the steel is cooled suddenly from above this critical range, this transformation is in a measure prevented, so that the conglomerate consists in part of this cementite, and in part of iron containing carbon actually dissolved, although normally insoluble in the iron at this temperature. It is retained in solution because the passage through the zone of temperature below the critical range, the zone in which the freedom of molecular motion is great enough to permit the carbon to slip out of solution, has been too rapid to permit this tendency to assert itself completely. This will be explained more fully in Chapter VIII.

In each case it is not only that sudden cooling restrains a change which normally tends to occur on cooling past a given temperature, but further that the metal appears to remain absolutely supersaturated with carbon.

Nor is this confined to alloys of iron. Wm. Campbell found that certain copper-tin alloys which were eutectiferous when cooled under normal conditions, were not when cooled very suddenly by quenching in water.* And it is probable that further investigation will show that there are many alloys of which much the same is true.

What here occurs is substantially this. The dissolved substance which, under normal conditions of slow freezing, would be found separated as a distinct entity, such as the graphite of cast iron, the eutectic of a eutectiferous alloy,—this dissolved substance is not thus found if the freezing is sudden. It is true

* "Microscopical Examination of the Alloys of Copper and Tin," *Proc. Institution Mechanical Engineers*, Dec. 20, 1901.

that, in certain cases, our failure to find in the suddenly cooled alloy this separated entity, which we do find when the cooling has been slow, may be due to a minuteness of structure so extreme that the microscope as yet fails to resolve it. By this I mean that, whereas in slow cooling the eutectic or other separated body has time to group itself into particles large enough to be seen by means of the microscope, in sudden cooling this opportunity is so much abridged that the individual particles, while actually present, are so small as to escape detection. In other words, this sudden cooling may actually prevent the formation of a eutectic, *etc.*, by inducing supersaturation or at least abnormally high concentration; or it may merely conceal the eutectic by giving it a structure so fine that it cannot be detected.

In the case of cast iron and steel we are confident that the action of the sudden cooling is not confined to such mere concealment, because it induces profound changes in the physical and chemical properties of the alloy, far too great to be referred to such mere comminution of structure.

It is possible that rapidity of cooling may also lower the temperature *aBc*. In the somewhat parallel case of the transformations in solid iron, Osmond early found that hastening the cooling lowered the temperature at which they occur.*

89. IN PARTICULAR, RAPID FREEZING SHOULD RESTRAIN MACROSCOPIC SEGREGATION. — Besides the foregoing general reason, there is a special reason why macroscopic or axial segregation should be restrained by sudden freezing. In §§ 81 and 82, pp. 94 and 97, and in Fig. 42, we saw that as the excess or solvent metal, the bismuth-bearing tin, freezes out, by the selection in freezing part of its bismuth fails to freeze; it is thus liberated, and it then tends to diffuse out into the open sea, thus gradually enriching that sea in bismuth. We further saw that the bismuth-content of each molten landlocked basin would be approximately that of the open sea at the time when landlocking took place. This was on the assumption that the progress of freezing was so slow that this liberated bismuth diffused itself out uniformly or nearly so, throughout that open sea. But the bismuth-content of each basin, more strictly speaking, should follow the bismuth-content of the littoral region of that sea, rather than the average

* "Transformations du Fer et du Carbone," 1888, p. 36.

of the whole sea, since it is this littoral part of the sea which is landlocked.

Now, if freezing is rapid, *i. e.*, if the position of the shore and littoral layers shifts centripetally rapidly, there will be so little time for the seaward diffusion of this liberated bismuth that the littoral layer, including that part of it landlocked in each basin, will be materially richer in bismuth than the average of the open sea. Thus more of the bismuth will be locked up in these landlocked basins, and there will consequently be less to migrate out centripetally to form finally the macroscopic or axial segregation, than if the freezing were slow. Thus in short, rapidity of freezing should in particular restrain axial segregation.

90. THE TWO FEATURES OF RAPID COOLING THROUGH THE FREEZING-RANGE, TAKEN JOINTLY. — We have now seen with regard to rapid cooling through the freezing-range that (1) in that it lessens the opportunity for diffusion in the already frozen layers, it leads towards greater residual segregation, and (2) in that it hastens the freezing itself, it leads towards less residual segregation, *i. e.*, it tends to lessen segregation.

Thus rapid cooling through this range has two opposite effects. Which of these is the greater may not easily be foretold. We may however note one consideration for our guidance. To take an extreme case in order to illustrate the principle to which I now refer, let us assume that the cooling through this range is extremely slow, occupying say a year. If that is not long enough for your imagination, select a longer period that will satisfy you. Let us further suppose that the rate of freezing is uniform throughout this period. At the end of eleven months or 92 per cent of the total time, some 92 per cent of the whole mass will have frozen; there then remains a month in which to equalize the composition of this mass by diffusion. Let us assume that this month is long enough practically to perfect this equalization.

At the end of 11.5 months some 96 per cent of the whole will have frozen, and there remain still two weeks to distribute through the previous frozen layers the excess of any element contained in the four per cent which has been deposited in these two weeks just ended. Let us assume that this is time enough practically to perfect this distribution.

Proceeding in this way we see that, if we only make the passage through the freezing-range slow enough, the extra op-

portunity for diffusion in the frozen layers will more than compensate for the extra opportunity for differentiation in freezing which the slowness of the freezing itself offers.

From such considerations our natural inference is as follows:

As between (1) extremely slow and (2) moderately slow cooling through the freezing-range, the extremely slow cooling ought to lead to greater homogeneousness through better opportunity for diffusion.

As between (1) extremely rapid and (2) moderately rapid cooling through this same range, the former may be expected to lead to greater homogeneousness through impeding the differentiating action of the freezing itself.

91. TAKING THE TWO PERIODS JOINTLY, WHAT PROCEDURE IN FREEZING-PLUS-COOLING SHOULD YIELD THE LEAST RESIDUAL SEGREGATION?— Now let us take these two successive processes, (1) cooling through the freezing-range, and (2) cooling from that range to the cold, and let us for convenience call these jointly "freezing-plus-cooling," a term hardly suited for general adoption but perhaps convenient for this present discussion.

Two sets of conditions suggest themselves, (1) that we are free to change artificially the rate of cooling at the end of the freezing period, so that we may if we so elect cool slowly through the freezing-range and quickly below it, or *vice versa*; or if we so elect quickly through both ranges, or slowly through both. This then is an artificially variable rate of cooling.

The other set of conditions is that we are not thus free; that if for instance we remove heat rapidly, and hence cool rapidly, through the freezing-range, we must allow the external conditions which have induced this rapid removal of heat, this rapid cooling, to continue undisturbed till the mass is cold, so that the cooling below the freezing-range also would be relatively rapid.

It is true that, even if we thus leave the external conditions of cooling undisturbed throughout the whole freezing-plus-cooling, *i. e.*, even if we do not vary the rate of removal of heat artificially, the fall of temperature will vary from inherent and natural, as distinguished from artificial, causes.

Two sources of such natural variation in the rate at which the temperature will fall deserve notice. They are as follows:

(1) The removal of heat will slacken progressively both during freezing and during the cooling from the freezing-point

downwards, simply because the temperature is continuously approaching that of the cooling medium, with the inevitable consequence that the flow of heat from the mass we are cooling to that medium must slacken as the temperature difference between the two decreases.

(2) The actual fall of temperature will be retarded during the freezing proper, by the liberation of the latent heat of solidification. Again, during this freezing the fall of temperature of the containing walls of the crucible, furnace, or whatever contains our freezing mass, will on this account outrun the fall of temperature of the freezing mass itself; therefore, as soon as freezing has ended and this liberation of heat has ceased, the fall of temperature of the mass just frozen will accelerate spontaneously. A like retardation and subsequent acceleration will occur whenever the mass in cooling passes a temperature or range of temperature in which occurs some exothermic transformation, such as the recalescence of steel.

But these variations or perturbations of the fall of temperature are natural; they are very slight compared with the artificial variations which we may introduce, for instance by allowing the mass experimented on to freeze extremely slowly in a furnace, the temperature of which is purposely held only a very few degrees below the freezing-range of that mass, and then, so soon as that mass has frozen, but before it has cooled many degrees below its freezing-point, while it is still say red-hot, plunging it into iced brine or some other freezing-mixture.

Let this suffice to explain the distinction between a natural and an artificially variable rate of cooling-plus-freezing.

Let us consider these two sets of conditions consecutively.

92. CASE I, THE RATE OF COOLING IS ARTIFICIALLY VARIABLE. — In this case, what rate of freezing-plus-cooling should be expected to lead to the least residual segregation? For given length of time available for the whole, it seems probable that it should be (1) rapid passage through the freezing-range, in order to restrain the initial segregation, followed by (2) slow cooling below that range. It is true that the quick passage through the freezing-range lessens the opportunity for equalization by diffusion in that range; but on the whole it seems probable that this loss may be compensated for by correspondingly retarding the cooling below the freezing-range or even by holding the alloy at

a stationary temperature slightly below the freezing-range for a time approximately that which we have gained by the rapid passage through the freezing-range. For in this range below the freezing-point, the equalizing tendency of diffusion is not thus offset by the opposing differentiating tendency of the freezing process. Hence, for given total time occupied by freezing-plus-cooling below the freezing-point, the greatest net equalization, *i. e.*, the minimum segregation, should be had by rapid freezing, followed by slow cooling or long sojourn at stationary temperature below the freezing-point.

This opinion, however, we cannot hold firmly, (1) because we do not know the relative force of effects (1) and (2) of Table 2, and (2) because we do not know how greatly the rate of diffusion is lessened in passing from the freezing-range to some point even slightly below it.

93. CASE 2, THE RATE OF COOLING IS NATURAL, *i. e.*, NOT ARTIFICIALLY VARIABLE. — Up to this point we have considered separately the effects of the rate of cooling in these distinct ranges of temperature, (1) the freezing-range and (2) the range between the lower or eutectic-freezing end of the freezing and the cold. For convenience the results of our study are grouped in Table 2, p. 112. To the manufacturing metallurgist, however, it would generally be so inconvenient to introduce any artificial change in the rate of cooling at the end of the freezing-period that, unless it offers some very great advantage, he will not, but will treat both ranges jointly as one whole. He will either cool through both ranges quickly, or through both ranges slowly, or through both ranges at some consistent intermediate rate, which will not involve artificially changing the rate of cooling at the end of the freezing-range and the beginning of the subfreezing-range.

Our next question, then, is which of the two, (1) natural rapid or (2) natural slow freezing-plus-cooling will give the least residual segregation, or in other words the greatest final uniformity? Clearly natural slow cooling should. If the whole cooling is to be very slow, this in both ranges leads towards equalization. If it is to be moderately slow, we may indeed think that, as far as the freezing-range is concerned, it would work less for uniformity than sudden freezing. But, on examining Table 2, and reflecting that principles (1) and (2) of that table are opposed to each other, we naturally infer that, in general,

the effect of the rate of cooling through the freezing-range will be less than the effect of the rate of cooling below that range; and hence that rapid freezing-plus-cooling will probably give more segregation than slow freezing-plus-cooling. This Roberts-Austen found true in his experiments on the influence of the rate of freezing-plus-cooling on the segregation of copper-silver alloys; * and such other direct evidence as is available points in the same direction.

To this conclusion the metallurgist may naturally object that, whereas in large steel ingots, which cool slowly, segregation is marked, it is insignificant in small steel ingots, or is generally thought to be. The answer is a simple one. It may well be that it is the size of the large steel ingot which, in spite of its slow cooling, causes its segregation to be very serious; and it is diffusion which alone can undo the segregation which freezing induces. We can easily see how this should come about. Diffusion of course is the only agency that in the slowly cooling ingot can remove the initial segregation already set up in freezing. But the great width of a large ingot in itself throws a serious obstacle in the way of thoroughness of diffusion, because of the implied great distance through which diffusion must transport the particles in order to efface initial heterogeneity.

But from this apparent slightness of segregation in small steel ingots we may draw an important inference. It is that principle 1 of Table 2 is probably a powerful one; for, except for this influence, we should expect that small ingots, because their size leads them to cool quickly, would be much segregated. The slightness of their segregation, then, we refer to the powerful influence of principle 1 (column 3, line 1 of Table 2), that rapidity of cooling in the freezing-range lessens segregation through lessening the initial heterogeneity.

As has already been pointed out, this discussion aims to consider only the non-eutectiferous alloys. Unfortunately, the data at hand, such as the segregated steel ingot, are those of eutectiferous alloys. This, of course, greatly lessens their value as evidence.

In the case of eutectiferous alloys there may be an agency,

* *Proc. Roy. Soc.*, 23, pp. 490-493, 1875.

and a powerful one, opposed to the equalizing action of diffusion. Every such alloy is a conglomerate of at least two distinct bodies. In slow cooling each of these bodies may tend to draw together, to coalesce, as in liquation processes; and this tendency one of these bodies may obey to a greater extent than the others, and may thus segregate during slow cooling. The effect of this segregating action is exactly the opposite of that of diffusion, on the degree of residual segregation. Space forbids going farther into this matter, than to point out this additional complication, and to warn the student that our deductions as to the probable course of events in non-eutectiferous alloys cannot be applied to eutectiferous ones without taking this additional influence into account. (See § 35 A.)

TABLE 2

RANGE	EFFECT OF RAPIDITY OF COOLING		FOR THE LEAST RESIDUAL SEGREGATION THE COOLING SHOULD BE
In the freezing-range	In that it lessens the initial heterogeneity	(1) It lessens segregation	Either extremely rapid or very slow
	In that it restrains diffusion in this range	(2) It increases segregation	
From the end of the freezing-range downwards	In that it restrains diffusion in this range	(3) It increases segregation	Very slow
Freezing-plus-cooling, i.e., both ranges successively	Case 1, the rate is variable artificially		Sudden freezing, with slow cooling thence
	Case 2, the rate is natural		Slow cooling

94. OTHER MODES OF GROWTH.—In § 78, p. 88, we saw that, besides the pine-tree mode of growth, there were others, some cube-wise, some sheet-wise. But in the present discussion, from § 78, p. 88, to the present section, we have, to fix our ideas, considered only the broad-branched pine-tree type.

To consider fully how far substituting these other types of growth would modify the conclusions at which we have arrived would carry us too far. But we may in general hold that, while the degree of landlocking and its consequences would vary from type to type, yet this would not affect our general inferences, which are based on the idea that the growth is partly onionwise and partly landlocking. For in each of these other modes of growth it seems clear that more or less landlocking and more or less onion-peel growth should be expected.

95. DIFFUSION IS IN BOTH DIRECTIONS FROM THE SHORE LINE.—Let us here note the fact, which tends to fasten the whole scheme in our memory, that diffusion takes place in both directions simultaneously, landward from the shore layer of the frozen or shore region, and seaward from the littoral layer of the still unfrozen or open sea. We have already noted in § 84, p. 100, this landward migration from the shore layer; and in §§ 82 and 89, pp. 97 and 106, this seaward migration from the littoral layer.

96. THE RATE OF FREEZING AND THAT OF SUBSEQUENT COOLING MAY SHIFT THE APPARENT BOUNDARIES OF THE EUTECTIFEROUS RANGE.—Turning to Fig. 33, p. 75, the ordinates passing through the points *a* and *c* give the composition of the two alloys which bound the eutectiferous range (§ 67, p. 74). By definition, alloys to the left of *a* when cold are simply bismuth-bearing tin, a solid solution of bismuth in tin; those to the right of *c* are simply stanniferous bismuth, a solid solution of bismuth in tin; those between *a* and *c* contain the eutectic in addition to such a solid solution.

But we must here distinguish between the true or normal position of these boundaries and their apparent position.

We have seen in §§ 71 and 72, pp. 78 and 79, that for equilibrium, the question whether a binary alloy of two metals of limited reciprocal solubility, such as bismuth and tin, will be (1) simply a solid solution, or will be (2) eutectiferous, depends solely on whether the total quantity of the two metals

present in the whole mass is such that one of them is or is not theoretically capable of dissolving the whole of the other when solid. If yes, the alloy is non-eutectiferous; if no, it is eutectiferous. This, then, gives us the position of these boundaries, a and c , for equilibrium. a and c thus represent respectively tin saturated with bismuth and bismuth saturated with tin, a point to which we shall return in § 105, p. 121.

But equilibrium, as we have already seen, is by no means always reached, and the actual conditions may vary on either side of it. And through such variations, an alloy which in equilibrium would not be eutectiferous may actually contain a eutectic, and another which normally is eutectiferous may actually lack the eutectic.

This really follows from what has gone before; but it may be well to run through the two cases, still considering, to fix our ideas, the specific case of freezing bismuth-bearing tin.

We have seen that sudden freezing may apparently give rise to supersaturation. Now suppose that an alloy, a bismuth-bearing tin, of which the composition is very slightly to the right of a , so that normally it should contain a very small quantity of eutectic, is thus rapidly frozen, so that the tin becomes supersaturated with bismuth, and sufficiently supersaturated to retain in solid solution the whole of the bismuth present. The alloy then consists solely of a solid solution of bismuth in tin and is actually wholly free from eutectic, although it would have been eutectiferous had this supersaturation not existed.

Turning now to the opposite case, let us consider an alloy the composition of which is slightly at the left of a , so that for equilibrium it would contain no eutectic; and let us assume that the conditions of freezing have been such that the normal degree of selection has taken place, and in particular that there has been no supersaturation. Let us further suppose that, at the moment which we are considering, this alloy has just undergone this selective freezing, and is beginning to cool from the freezing-point downwards. In the frozen mass diffusion is at work, transferring to the earlier deposited layers, initially poor in bismuth, part of the excess of bismuth which the later deposited layers richer in bismuth contain, thus aiming to make the bismuth-content of the whole uniform. But suppose that this diffusion is so greatly restrained by rapid cooling from the freezing-point downwards that

but little of this transfer occurs, so that the initial heterogeneousness is far from being effaced. This leaves in the last deposited layers much more bismuth than the average of the whole; so that even though, as the present case assumed, there may not be in the mass as a whole enough bismuth to saturate the tin, yet there may be more than enough in these last deposited layers, which therefore are eutectiferous. Thus, in short, the eutectic may exist locally in parts of an alloy, the composition of which taken as a whole is outside the limits which the eutectiferous range would have if equilibrium existed.

Looking at the matter from another standpoint, we saw in § 64, p. 72, that if the layers freezing out, (as distinguished from the average of the already frozen continent), reach the saturation-point before the whole open sea has frozen, then some eutectic will form. The enrichment of these layers might well reach the saturation-point thus, even if the average composition of the whole mass was below the saturation-point. In this case diffusion tends to efface the eutectic; if diffusion is arrested by rapid cooling, this effacement may be incomplete; some of the eutectic may persist.

To sum this up, supersaturation may shift the apparent boundaries of the eutectiferous range towards each other, shortening or even effacing that range; incompleteness of diffusion may shift them away from each other, thus lengthening that range.

We have here been considering only the rate of cooling as influencing the degree of saturation and of diffusion. But in general, anything which leads to supersaturation should thereby tend to shorten the eutectiferous range, anything which restricts diffusion should thereby tend to lengthen it.

97. SOLUBILITY FALLS WITH THE TEMPERATURE. — For simplicity one point has hitherto been ignored, *viz.*, — that in accordance with the general rule that the solvent power of any given substance for any other usually increases with the temperature, we should temporarily assume that the solvent power of solid tin for solid bismuth decreases as the temperature falls. On this account during the saturation division ($B'C$, Fig. 31, p. 71), since the temperature is constantly falling and since the successive solid layers should be saturated with bismuth for the existing temperature, their percentage of bismuth should progressively de-

crease.* This is in sharp contrast with the progressive enrichment in bismuth of the layers deposited during the subsaturation period. It does not, however, invalidate any of the inferences which we have thus far drawn.

CHAPTER V.—OTHER SERIES-CURVES OF BINARY ALLOYS FORMING NO CHEMICAL COMPOUND

98. SATURATION-POINT OR SO-CALLED CRITICAL CURVES.†—*General Assumption.* Throughout the discussion of this subject, §§ 98 to 111, pp. 116 to 132, it is assumed that the conditions are those of complete equilibrium, and the influence of lag, surfusion, supersaturation, and every form of disturbance is ignored.

In order to understand what is meant by a saturation-point curve let us consider the case of a molten alloy of two metals, forming no chemical compound with each other. Here, as in case of two aqueous liquids, while the two generally dissolve in all proportions to form homogeneous solutions with each other, yet in certain cases they dissolve only within certain limits, and the same is true of certain molten binary alloys. In certain cases the molten alloy is not one homogeneous mass, because the two metals are in such proportions that neither can dissolve the whole of the other. They therefore exist as independent saturated solutions

* On account of this fall of the saturation-point, the layers which are saturated with bismuth at the time of their deposition, would become supersaturated as the temperature descends farther; and a point to be investigated is whether, to relieve this supersaturation, part of the excess of bismuth separates itself in minute grains within the solid metal. The condition which would favor this separation would be very long exposure to a temperature far enough below the freezing-point (at which the deposited layers were just saturated) to cause the supersaturation to be pronounced, yet high enough to permit such molecular transformation, such escape of the excess of bismuth from the state of solution, and its aggregation into particles large enough to be detected.

† These curves are called "critical curves," though the appropriateness of this name may be disputed, since it is not evident that the mutual solubility of two metals is a more critical matter than the freezing-points of their alloys. To the name "saturation-point curves," which is here proposed, no such objection applies.

of each in the other. These solutions may be mechanically mixed as an emulsion, but on long standing they tend, as in the case of the lead-zinc alloys, to separate into two layers, plumbiferous zinc (the lighter) floating above, and zinciferous lead (the heavier) lying beneath.* (Cf. § 73, p. 83.)

The abscissa OD in Fig. 43 represents the proportion of molten metal G which molten metal O can dissolve at temperature O_* , and the curve DF indicates how the solubility of G in O increases as the temperature rises. In the same way, the intercept GE represents the proportion of metal O which metal G can dissolve at temperature O_* , and the curve EF represents the increase in the solubility of O in G with rise of temperature. At given temperature θ , O can dissolve θf per cent of G , and G can dissolve gH per cent of O . Hence at this temperature, an alloy

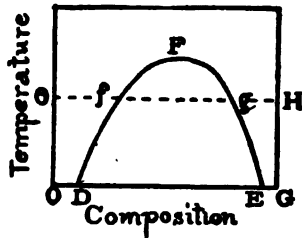

Fig. 43. Saturation-point Curve of Molten Binary Alloys.

consisting of metal O with less than θf per cent of metal G is an unsaturated solution of G in O ; one with θf per cent is a saturated solution of G in O ; one with less than gH per cent of metal O is an unsaturated solution of metal O in metal G ; one with gH per cent is such a solution but saturated; and alloys between θf and gH are a mixture of saturated solutions, (1) of θf per cent of G in O , and (2) of gH per cent of O in G .

The alloys represented by different points along the line fg will be mechanical mixtures of these two saturated solutions, in different proportions.

At F these two curves meet, so that at this temperature and at all higher ones the two metals dissolve in each other in all proportions. And in general, any point outside the line DFE rep-

* Alder Wright, *Jour. Soc. Chem. Indust.*, XI, p. 492, June 30, 1892.

represents an unsaturated solution of one metal in the other; any point on that line represents a saturated solution of one metal in the other, and any point within it a mechanical mixture of the two saturated alloys, (1) *O* saturated with *G* and (2) *G* saturated with *O*, saturated that is to say for the existing temperature. That each of these alloys should be saturated, assuming equilibrium to have been established, has already been shown in § 73, p. 80, where we saw that "if there is more of each metal than suffices to saturate the other, the condition of equilibrium is that of a mechanical mixture of particles of the two metals, each saturated with the other; in other words, that of a pair of saturated solutions. Manifestly this is as true of the molten as of the solid state."

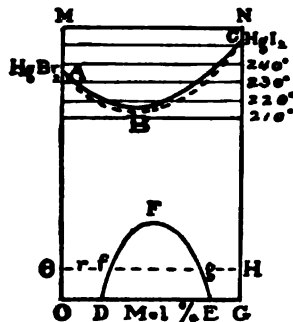

Fig. 44.

Saturation-point and Freezing-point Curves of Mercuric Bromide and Iodide.

Roberts-Austen and Stansfield, *Rapports Présentés au Congrès International de Physique*, I, Paris, 1900, p. 382; from Reinders, *Kon. Akad. van Wetens. te Amsterdam*, p. 146, 1899.

99. SATURATION-POINT CURVES IN SOLID METAL. (1) NON-EUTECTIFEROUS ALLOYS. — Turning now to the solid state, the simplest case is that of two metals which, like gold and silver, are soluble in each other in all proportions at and even somewhat below their freezing-points. But two such metals thus soluble without limit, may at still lower temperatures be of limited solubility, when the condition is like that of the iodide and bromide of mercury, shown in Fig. 44, in which the freezing-point curve *ABC* of these substances also is given. Here, as before, *DF* and *EF* represent the solubility of each substance in the other for temperatures from *O* to *F*; and, as before, any point

outside this curve (and below the freezing-point curve) represents an unsaturated solid solution of one in the other. Any point on *DFE* represents a saturated solid solution. The normal condition represented by any point inside the line *DFE*, the condition towards which equilibrium tends, is that of a mechanical mixture or conglomerate of two solid solutions, one of iodide in bromide, the other of bromide in iodide, each saturated for the existing temperature. The reasons why such a state of affairs is true of molten alloys as explained in § 98, p. 116, apply equally to the case of the solid state.

What has now been said of the solid iodide and bromide of mercury applies with equal force to the solid alloys of any two metals, of which the reciprocal solubility, while unlimited at the freezing-point and even somewhat below it, becomes limited at some still lower temperature. Only, such an alloy, when it cools past the line *DFE*, Fig. 44, instead of obeying this tendency to break up into two saturated solid solutions may remain as a single supersaturated solution. Or if the solvent metal, instead of becoming supersaturated, actually does expel from itself in the solid alloy the excess of the dissolved metal as fast as, by fall of temperature, its solubility in the solvent metal decreases; yet the particles in which this excess thus separates itself may well be so extremely minute, thanks to the rigidity of the solid alloy, as to be invisible under the microscope. Further investigation is needed to throw light on this question.

Position of the Saturation-point Curve under Various Conditions, and its Relation to the Freezing-point Curve

100. CASE 1, THE SATURATION-POINT CURVE LIES WHOLLY BELOW THE FREEZING-POINT CURVE, *i. e.*, the reciprocal solubility is complete for the molten state at all temperatures, and for the solid state for a certain distance below the freezing-point of the eutectic, but not at still lower temperatures. This is the case which we have considered in the last section (Fig. 44).

101. CASE 2, THE TWO METALS ARE COMPLETELY INSOLUBLE IN EACH OTHER AT ALL TEMPERATURES, BOTH WHEN SOLID AND WHEN MOLTEN. — In this case the saturation-point curve really corresponds to the axes say *OM* and *LN* of Fig. 24, p. 54, both below and above the freezing-point curves.

102. CASE 3, THE TWO METALS ARE WHOLLY INSOLUBLE IN EACH OTHER AT ALL TEMPERATURES WHEN SOLID, BUT SOLUBLE IN EACH OTHER IN ALL PROPORTIONS AND AT ALL TEMPERATURES WHEN MOLTEN.—In this case, for the solid state the saturation-point curve as before corresponds to the axes *OM* and *LN* of Fig. 24; while for the molten state it can hardly be said to exist.

103. CASES IN WHICH THE SATURATION-POINT CURVE MEETS OR CUTS THE FREEZING-POINT CURVE.—In the three cases which we have now considered (§§ 100 to 102) the reciprocal solubility for each state, molten and solid, is, in the freezing-point range of temperature, either nil or unlimited. In these cases the two curves (saturation and freezing-point) can hardly be said to meet each other; but a class of cases remains in which, in this freezing-point range, there is limited reciprocal solubility either (Case 4) in the solid state, or (Case 5) in the molten state, or (Case 5 β) in both states. In each of these cases the saturation-point curve meets the freezing-point curve, and in Case 5 it affects the shape of this latter curve in a way which varies with the attendant conditions, as we shall see in §§ 107 and 111, pp. 121 and 132. Table 3 recapitulates these conditions:

TABLE 3

FOR THE MOLTEN STATE RECIPROCAL SOLUBILITY IS COMPLETE	THE SATURATION-POINT CURVE CUTS THE TWO V-BRANCHES OF THE FREEZING-POINT CURVE	RECIPROCAL SOLUBILITY FOR THE SOLID STATE IS
Case 4. At all temperatures		Limited
Case 5. Only above a certain temperature	A, at the same temperature	α , Nil, (<i>i.e.</i> , the two metals when solid are wholly insoluble in each other) β , Limited (<i>i.e.</i> , the two metals when solid are somewhat soluble in each other)
	B, at different temperatures	α Nil β Limited

104. CASE 4, FOR THE MOLTEN STATE RECIPROCAL SOLUBILITY IS UNLIMITED AT ALL TEMPERATURES, BUT IN THE

FREEZING-POINT RANGE IT IS LIMITED FOR THE SOLID STATE. — In this case there can hardly be said to be any saturation-point curve for the molten state; while for the solid state this curve is like that sketched at *Daa'* and *Ecc'* in Fig. 49, p. 136. This is sketched only by eye, to give a general idea of the family to which such curves belong.

105. IN THIS AND ALL LIKE CASES THE SATURATION-POINT CURVES PASS THROUGH THE NORMAL OR EQUILIBRIUM BOUNDARIES OF THE EUTECTIFEROUS RANGE. — This we have already established in § 96, p. 114. For limit *a* of the eutectiferous range represents the composition at which solid metal *H* is just saturated with solid metal *G* (Fig. 49) at that temperature, so that any further increase of metal *G*, by tending to supersaturate metal *H*, would give rise to a eutectic. So with point *c*, *mutatis mutandis*.

106. CASE 5, FOR THE MOLTEN STATE RECIPROCAL SOLUBILITY IS COMPLETE ONLY ABOVE A CERTAIN RANGE. — In this case the saturation-point curve will be found above the freezing-point curve, *i. e.*, extending into the part of the diagram which represents the molten state. If there is a certain degree of reciprocal solubility for the solid state also, then the saturation-point curve will be found below the freezing-point also. If there is not, then the saturation-point curve for the solid state is represented by the axes, as in Case 3.

It remains to consider the influence of the saturation-point curve on the freezing-point curve for subcases 5 *A* and 5 *B*; and also to consider the relative position of the saturation-point curve for the solid and molten states respectively. The former of these subjects we will now consider in §§ 107, 108 and 110, pp. 121, 125 and 126, the latter in § 109, p. 126.

107. SUBCASE 5 *A*, THE SATURATION-POINT CURVE CUTS THE TWO UPPER OR V-BRANCHES OF THE FREEZING-POINT CURVE AT THE SAME TEMPERATURE.*

a *The two metals when solid are wholly insoluble in each*

* The assumption on which this case rests, that the saturation-point curve cuts the two branches of the freezing-point curve at exactly the same temperature, is, of course, an extremely improbable one, and, mathematically speaking, presumably an impossible one. It may be regarded as a limiting case, and is given here first, only because it is somewhat simpler than the other case in which the saturation-point curve cuts the freezing-point curve at different temperatures.

other. On this assumption, the freezing-point and saturation-point curves are of the family shown in Fig. 45.

Let us test the shape of *AMJC* by following the freezing of three different alloys, those with *R*, *S* and *T* per cent respectively, of metal *G*.

(1) *Alloy R.* This in cooling would begin freezing at *r* with the solidification of metal *H* and enrichment of the mother-metal in metal *G*, as in the common course of selective freezing; so that the temperature and composition of the mother-metal at successive instants would be represented by a series of points between *r* and *M*. In short, the temperature and composition of the mother-metal slide from *r* to *M*. But on reaching *M* this sliding is arrested, and the mother-metal will now freeze without further fall of temperature as the eutectic, breaking up in freezing into separate particles of the two metals *G* and *H*.

The reason why selective freezing should cease on reaching *M*, and that the mother-metal should there freeze without further selection, *i. e.*, as a whole, is of course the same which leads to the freezing of the eutectic as a whole in any ordinary alloy as soon as the eutectic composition and freezing-point are reached. At each instant during the selective freezing from *r* to *M* the mother-metal has been at its then freezing-point, and it has avoided freezing as a whole by ejecting from itself part of the excess or solvent metal *H*, and so becoming enriched in the dissolved metal *G*, and thereby acquiring a lower freezing-point. This can go on only so long as selective freezing is capable of leading to an alloy of a lower freezing-point. Now this possibility ceases when the temperature and composition of the mother-metal reach *M*, for that is by assumption the freezing-point of the most fusible alloy of the series. Indeed, no possible shifting of composition of the mother-metal could further defer freezing. Moving it to the left would make it still more infusible; moving it to the right would simply split it up into a mechanical mixture of (1) an alloy of composition *M* and (2) another alloy of composition *J*, both infusible at the existing temperature.

(2) *Alloy S.* On cooling to *M*, this alloy would be in the condition in which the mother-metal was at temperature *M* in the case of alloy *R*, and would freeze there as a whole for the same reason.

(3) *Alloy T.* On cooling past *F*, the molten alloy splits up

into two saturated solutions (1) of *G* in *H*, and (2) of *H* in *G*; the composition of these shifts during further cooling, following the curves *FM* and *FJ*, till on reaching temperature *M*, these

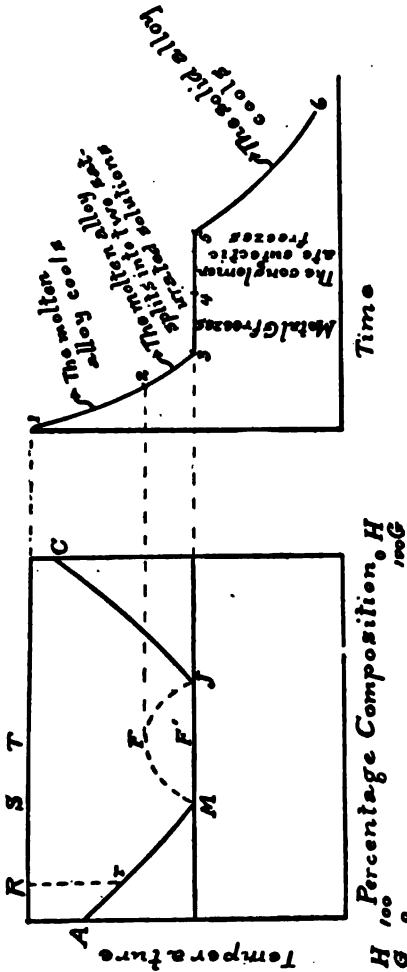

Fig. 45. Freezing-point Curve of Alloys of two Metals of Limited Reciprocal Solubility when Molten, but Complete Reciprocal Insolubility when Solid.

Subcase 5A, the Solubility Curve cuts both upper Branches of the Freezing-point Curve at the same Temperature.

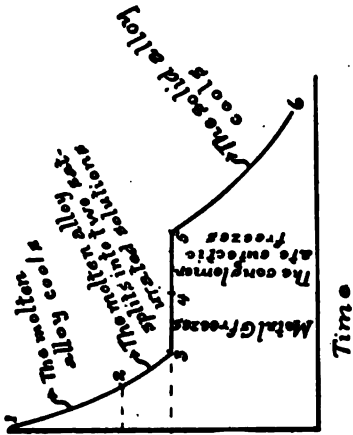

Fig. 46. Cooling Curve of Alloy *T*, of Fig. 45.

alloys have respectively composition *M* and composition *J*, and each is therefore at its freezing-point.

At first we might suppose that both these molten alloys would now freeze simultaneously, because they are both at their freezing-point; and that in freezing they would split up simulta-

neously into separate particles of metal G and of metal H . But we must here note that, while the two molten alloys have by assumption the same melting-point, the two component metals have different ones. What would actually happen, we therefore infer, is that the more infusible metal G would begin freezing in preference to metal H , since G is now farther below its freezing-point C , and the temperature lever-arm, so to speak, of the tendency to freeze is therefore greater for G than for H . But the removal of some of metal G from the molten mass taken as a whole, would shift the composition of the remainder of that mass to the left, which means that the components of the two molten alloys would rearrange themselves somewhat as in § 73, p. 80; *i. e.*, that as metal G froze out progressively, so progressively would the proportion of molten alloy J decrease and that of molten alloy M increase.* This would continue until, by this removal of metal G from the molten mass, the residual molten alloy had reached composition M . In short, the composition of the residual molten mother-metal, *i. e.*, the average of its two components M and J , which average initially was F' (the same as T), would gradually travel to the left until it reached M . Once this composition is reached, all further differentiation of the mother-metal ceases; it has now reduced itself to a single molten component M , and this should freeze without further differentiation or selection, like any other eutectic, splitting up into alternate particles of the two component metals H and G .

The cooling curve for such a case is shown in Fig. 46. From 1 to 2 the molten alloy cools without change; from 2 to 3 it splits up into two saturated solutions, the composition of which travels progressively from F to M and from F to J of Fig. 45.

From 3 to 4 metal G freezes out, and the composition of the residual molten mother-metal as a whole (Fig. 45), *i. e.*, the

* For the benefit of those already familiar with the phase rule it may here be pointed out that this rule leads us to expect the procedure here indicated at temperature MJ , rather than that both metals H and G should freeze out simultaneously. This it does because this latter supposition implies the simultaneous presence of four "phases," molten alloys M and J , solid H and solid G , four phases with only two components. In the procedure which I have sketched there are at no instant more than three phases.

average of its two component saturated solutions, travels to the left from F' to M .

At 4 further differentiation of the remaining molten mother-metal ceases, and from 4 to 5 it freezes as a whole like any other eutectic, splitting up into alternate particles of metal H and metal G .

From 5 to 6 the solid alloy cools.

We here see how the fact that the saturation-point curve extends above the freezing-point curve changes the shape of the latter. In this particular case it simply cuts off the apex of the

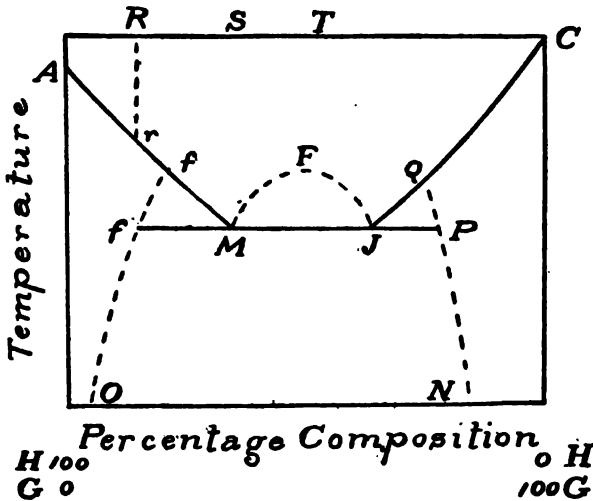

Fig. 47. Freezing-point Curve of Alloys of two Metals of Limited Reciprocal Solubility, both when Molten and when Solid.

V , which lines AM and CJ if produced would form, as they do in Figs. 24, 27, 28, 33 and 49.

108. SUBCASE 5 $A\beta$. — *The two metals when solid are somewhat soluble in each other.* Next let us suppose that the two metals, instead of being absolutely insoluble in each other when solid, are somewhat soluble reciprocally, but much less so than when molten. This assumption calls for saturation-point curves for the solid state, but it also implies that they lie respectively to the left-hand of M and the right-hand of J , as shown in Fig. 47.

Considering the cooling of an alloy initially of composition

and temperature T , when its temperature sinks to F it will, as in case a , split up into two saturated molten solutions, the composition of which during further cooling travels from F to M , and from F to J ; so that on reaching this temperature MJ we have the same condition of affairs as in case a . With further removal of heat from the system, it tends to freeze, generating solid alloys f and P .

But here again, just as in case a , it is the more infusible of these two solid alloys that should actually freeze first by preference. Let us assume that it is alloy P which is the more infusible of the two. It therefore begins freezing out, and the average composition of the residual molten mother-metal in consequence travels to the left until, as in case a , this average composition finally reaches M , *i. e.*, until by the rearrangement of the components of the mother-metal and the freezing out of alloy P , the whole of molten alloy J has been removed and only molten alloy M remains. Then, as before, this molten alloy M should freeze like any other eutectic, splitting up into alternate particles of solid alloys f and P respectively.

In short, the whole proceeds exactly as in case a , except that when freezing begins, that which freezes out first is not pure metal G , but G saturated with H , and that when the composition of the residual mother-metal eventually reaches M , the alternate particles of the eutectic into which it now in freezing splits up are, not pure metals H and G , but saturated solid solutions of G in H and of H in G .

109. RELATIVE POSITION OF THE SATURATION-POINT CURVE FOR THE SOLID AND MOLTEN STATES. — Since the solubility of each metal in the other should naturally be much less when both are solid than when both are molten, the saturation-point curves for the two states should be related to each other as shown in Fig. 47; that is to say, the curve for the solid state should lie to the left of M and to the right of J . In other words, there should be a sharp jog like $f'M$ and QJ between these curves for the solid and molten states respectively.

110. SUBCASE 5 B , THE SATURATION-POINT CURVE CUTS THE TWO UPPER OR V-BRANCHES OF THE FREEZING-POINT CURVE AT DIFFERENT TEMPERATURES. — a . *The two metals when solid are wholly insoluble in each other.* In this case the freezing-

point curve assumes the peculiar shape shown in Fig. 48. Here the upper freezing-points for alloys containing between 70 and 100 per cent of *H* are represented by *AM*, and those for alloys between 0 and 20 per cent of *H* by *BJ*; and the lower freezing-points for these two regions will be on the lines *DM* and *J'E*. For alloys of intermediate composition, containing between 20 and 70 per cent of *H*, the upper freezing-point is *JK'M* and the lower freezing-point is *J'M*.

To test this let us follow the cooling of a few different alloys containing respectively *I*, *F*, *T* and *Q* per cent of metal *G*.

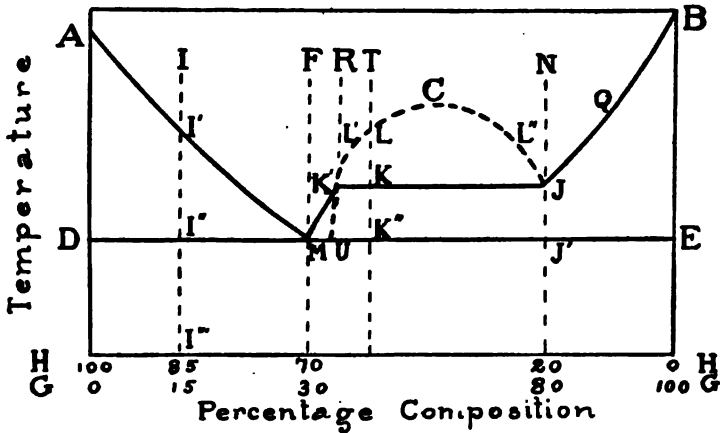

Fig. 48. Freezing-point Curve of Alloys of two Metals of Limited Reciprocal Solubility when Molten, but Complete Reciprocal Insolubility when Solid. Subcase 5B, the Solubility Curve Cuts the Upper Branches of the Freezing-point Curve at Different Temperatures.

Alloys I and F. The shape of the freezing-point curve at *M* and at the left of *M* is shown by the same reasoning that established the corresponding part of Fig. 45. (See alloys *R* and *S* of Fig. 45.)

Alloy T is a molten solution of *G* in *H*, which on cooling to the saturation-point curve becomes saturated, and on passing below it splits up into two saturated molten solutions (1) a large quantity of a solution of *G* in *H*, and (2) a small quantity of a solution of *H* in *G*. When the temperature has fallen to *L*,

alloy 1 will contain L' per cent of G dissolved in $100 - L'$ per cent of H , and alloy 2 will contain $100 - L''$ per cent of H dissolved in L'' per cent of G . When the temperature falls to K , alloy 1 will contain K' per cent of G dissolved in $100 - K'$ per cent of H , and alloy 2 will contain $100 - J$ per cent of H dissolved in J per cent of G . In short, the composition of these two alloys will be K' and J respectively. Alloy J , however, will now be at its freezing-point, and on further removal of heat, but without further fall of temperature, it will begin freezing.

In the freezing which now takes place alloy J should in effect deposit only metal G , as we see on trying to imagine the contrary. Suppose that the first flake of alloy J in freezing at temperature J does so without selection, *i. e.*, that it deposits a flake of composition J . As metals H and G by assumption are insoluble in each other, this first flake must (if equilibrium is reached), break up into particles of pure G and separate particles of pure H . But these pure particles of H , exposed as they are in the very act of freezing to alloy K' , which is a saturated solution of G in H , should immediately remelt and reënter alloy K' , since the alloy which this reëntering would create is fusible at the existing temperature, because it has more than K' per cent of H , *i. e.*, because its composition lies to the left of K' . This remelting then would give us two molten alloys, alloy J , and an alloy with composition to the left of K' .

But as the mean composition of the mother-metal would still be between J and K' it would immediately rearrange itself into a mechanical mixture of two alloys of composition J and K' respectively (§ 73, p. 80). The effect of the freezing and remelting which have taken place at temperature J thus would be to eliminate from the molten mass a small quantity of metal G , and so to shift the average composition of the mother-metal from K toward K' .

But this shifting will leave the mother-metal as before in the condition of a mechanical mixture of molten alloys J and K' , because at temperature J this is the constitution of any mother-metal the average composition of which lies anywhere between J and K' . So that, as regards farther freezing, on farther removal of heat from the system, we have exactly the same condition of affairs that we had when the first flake began to freeze. Hence,

for the same reason as before, the next step in the freezing is in effect to eliminate from the mother-metal a second small quantity of metal G , to be followed by a second rearrangement of the residual mother-metal so that it contains a smaller proportion of alloy J and a larger proportion of alloy K' . Thus, its average composition travels a second step to the left. Following this, flake by flake, what really happens is that metal G begins freezing out at constant temperature, and that the composition of the mother-metal progressively travels from K to K' , which means that the proportion of alloy J is constantly diminishing and that of alloy K' is constantly increasing until, when the average composition of the now residual molten mother-metal reaches K' , the whole of alloy J has been removed by the freezing out of the metal G , and the mother-metal now consists exclusively of alloy K' . The temperature will thus remain constant during this freezing out of alloy J .

Now that the molten mother-metal has been reduced to a single constituent, alloy K' , the condition of things is practically the same as in any simple case of selective freezing; for instance, it is parallel with the condition which exists when, in Fig. 24, p. 54, the alloy of composition G has cooled to temperature P . In cooling from H to P part of the excess-metal (lead) has frozen out, so that the composition of the residual mother-metal has traveled from H to P . With further fall of temperature the lead continues freezing out, and the composition and temperature of the mother-metal slide along the line PB .

So, in our present case, Fig. 48, with further fall of temperature, metal G continues freezing out, and its freezing bears such a relation to the fall of temperature that the composition and temperature of the mother-metal for every successive degree of temperature reached remain on the line $K'M$; in short, the temperature and composition of the mother-metal slide along $K'M$, there reaching the freezing-point of eutectic, and of course simultaneously reaching the eutectic composition.

At K' the mother-metal is H exactly saturated with G . As the temperature begins to descend below K' some of G begins freezing out, thus leaving in the mother-metal less G than suffices to saturate it at temperature K' , assuming that the continuation of the saturation-point curve $K'U$ is inclined to the right of the

freezing-point curve $K'M$, as drawn in Fig. 48.* But with the simultaneous incipient fall of temperature from K' the solubility of G in H simultaneously falls. For simplicity let us assume that this fall of the solubility is not so great that the proportion of G now in the mother-metal suffices to saturate it; in other words that the freezing-point curve $K'M$ is more strongly inclined than the continuation of the saturation-point curve $CK'U$, so that, as the composition and temperature of the mother-metal slide along $K'M$ the mother-metal first ceases to be saturated with G and then progressively falls farther and farther short of being saturated with G , *i. e.*, grows farther and farther unsaturated with G . In this case the mother-metal throughout the remainder of the freezing remains a single unsaturated solution, quite as in Fig. 24.

We may actually sketch the part $K'U$ of the saturation-point curve for the molten state to indicate that it actually lies to the right of the section $K'M$ of the freezing-point curve. Indeed, this prolongation $K'U$ can sometimes be determined by the phenomena of surfusion.

Once the temperature has fallen to M , the mother-metal will begin to freeze unselectively,† like any eutectic, simply because no selective form of freezing can (normally) postpone complete freezing. In freezing the eutectic will, like any other, split up into its components H and G , assumed to be insoluble in each other when solid, and, therefore, each pure.

* The angle between lines $K'M$ and $K'U$ may vary and conceivably might fall to zero, so that $K'M$ would coincide with $K'U$. In this case the line should be drawn double, a solid line to indicate this section of the freezing-point curve and a broken line to indicate this section of the saturation-point curve.

† That the freezing at M will be unselective is seen readily on trying to suppose the opposite, *i. e.*, that it is selective. Selective freezing can occur only through a selection which gives to the mother-metal a freezing-point lower than the existing temperature. But such selection cannot occur through freezing out of part of metal G , because that would move the composition to the left and would make the mother-metal more infusible. The freezing on the other hand cannot be made selective in the sense that metal H freezes out, because that would in like manner shift the composition of the mother-metal to the right, and this also would make it more infusible, and in particular infusible at the existing temperature M .

Thus, for initial composition T we have two freezing-points, K and K'' . The same would be true of any alloy of composition between R and N . For alloys between R and F , the upper freezing-point will be on the line $K'M$ and the lower freezing-point will be on the line MJ' .

This then gives us the freezing-point curves between F and N , *viz.*, for the upper freezing-point $MK'J$ and for the lower freezing-point MJ' .

Alloy Q. The series of alloys between N and B will have for the upper branch of the freezing-point curve $BJK'M$, and for the lower branch $J'E$. Take for instance alloy Q ; it will begin freezing selectively by the solidification of the excess or solvent metal G , and the composition and temperature of the mother-metal will, as in all like cases, slide from Q to J . But as the temperature starts to descend below J , the composition of the mother-metal crosses the solubility curve, and the mother-metal therefore splits up into a mechanical mixture of two alloys of compositions K' and J respectively.

But the molten mother-metal has now reached the same condition that it reached when, starting initially with composition T , it had cooled to temperature K , in that it is now a mechanical mixture of molten alloys J and K' . And, just as in that former case, with further removal of heat metal G in effect begins freezing out, and consequently the average composition of the mother-metal travels to the left from J to K' . Then, the freezing out of G still continuing, the temperature and composition of the mother-metal, quite as before, slide from K' to M . Finally at M the temperature again remains constant while the whole of the residual mother-metal freezes without selection, splitting up in freezing into the conglomerate eutectic of alternate particles of metal G and metal H .

Alloys intermediate in composition between Q and B will, in freezing, follow the same course as Q , and in particular they will all have a second or lower freezing-point on the line $DMJ'E$; in other words this line will extend clear to the right-hand side of the diagram. The reason for this is that, thanks to the assumed complete insolubility of H in G when solid, at whatever point between J and B the initial composition of the molten alloy lies, when on cooling to the line BJ freezing begins, it is metal G alone which freezes out; so that, no matter how little of H

is present, *i. e.*, no matter how little to the left of B the initial composition of the whole lies, that quantity of H unimpaired will continue to accumulate in the mother-metal. Hence, when the temperature of the mother-metal falls as low as J , there will still be that same quantity and hence a finite quantity, of metal H present; in short, the mother-metal will now have temperature and composition J .

But in that it thus has this composition and temperature, it is in the same condition that alloy Q was when it reached temperature J ; and therefore its further behavior, on further abstraction of heat, will be the same as that of alloy Q from this same time. The temperature of the molten mother-metal will remain constant as its composition gradually slides from J to K' , and its temperature and composition will then slide from K' to M . And since up to this time nothing but metal G has frozen out, the same original quantity of metal H will now be present in the mother-metal; so that this, in now freezing unselectively, will yield the conglomerate eutectic, containing the whole of the initial metal H .

In short, no matter how little H is initially present, that whole quantity will be found in the eutectic conglomerate formed at M ; or in other words there will be a conglomerate eutectic freezing-point at temperature M , no matter how little H is present, so that the line representing this lower freezing-point extends clear to the right-hand end of the diagram.

Comparing Figs. 45 and 48, we see that the essential difference is that in Fig. 45 the distance JJ' is reduced to nil. We may therefore regard subcase 5A as simply a special example of subcase 5B.

III. SUBCASE 5 B β , THE TWO METALS WHEN SOLID ARE SOMEWHAT SOLUBLE IN EACH OTHER. — Comparing §§ 107 and 108, pp. 121 and 125, and in particular comparing Figs. 45 and 47, we see that the effect of changing the assumed condition for the solid state from complete insolubility to limited solubility, was, as regards the diagram, to shorten the eutectic freezing-point line so that instead of running completely across the diagram it is bounded by the points f and P , and to create the saturation-point lines Off' and NPQ . As regards the procedure in freezing the effect of this change was that, instead of

pure metal H , it was H saturated with G that froze out, up to the time when the mother-metal reached composition J ; and that during the remainder or eutectic part of the freezing, the conglomerate eutectic which froze consisted of alternate particles of H saturated with G and of G saturated with H , instead of pure H and pure G .

Applying the same reasoning to the present case would lead to the same changes, both in the diagram and in the course of the freezing which that diagram depicts.

112. DETERMINATION OF THE SATURATION-POINT CURVES FOR THE SOLID STATE. — While these saturation-point curves for the solid state are not readily determined, we may yet reach an approximation to them in some cases. Thus, to find the solubility θf of G in O (Fig. 44) at given temperature θ° , we may heat to θ° a very thin strip of O in contact with an excess of G , and hold them at θ° for several different periods, cooling them and then determining after each heating and cooling what percentage of G has been absorbed by O by diffusion, and thus determining how much of G can thus be forced into O .

Conversely, how much of G can be retained by O at θ° may next be determined. The alloy which we should treat in this case should contain rather more of G than our foregoing absorption test succeeded in forcing into O , because an absorption test cannot pass saturation θf , and is likely not to reach it, while our present retention test will leave O at least saturated and probably much supersaturated with G , *i.e.*, will leave more than θf of G in O . We heat this alloy well above θ° , or better above its melting-point, then cool it to θ° , hold it there for a long period, then quench it in water to retain the degree of concentration retained at θ° .

We then examine the alloy under the microscope, to see whether under these favorable conditions any excess of G has separated out within the solid alloy; and if possible we try to get an approximate idea of the proportion of G that has thus separated out, remembering that it should not be pure G but G saturated with gH per cent of O that should thus separate out. Should any separation of G be detected, we infer that the percentage of G in the alloy is greater than θf , and we make a second approximation, using an alloy containing less of G , *etc.*

If, as will probably be the case, the results of the absorption and retention tests do not closely agree, the former ones representing undersaturation or less than θf , and the latter ones supersaturation or more than θf , we at least establish limits between which the true saturation-point lies. Sharply defined results are hardly to be hoped for, because the approach to the saturation-point from either direction is likely to be asymptotic, or at least extremely slow towards the end, in a solid and relatively cool alloy.

113. DETERMINATION OF THE SATURATION-POINT CURVES FOR THE MOLTEN STATE. — To determine the two points of the saturation-point curve for a given temperature T we might proceed as follows.

The two metals should be melted in a crucible under some protecting coating, such as potassium cyanide, and heated to a temperature T' considerably higher than T , and very thoroughly mixed. In deciding on the temperature T' the question of loss by volatilization should be considered. In no case should the temperature T' approach the boiling-point of either metal.

The mixed metals should then be poured into a narrow clay tube, perhaps 8 inches long, preheated to T' , closed at one end and capable of being stoppered tightly at the other. While at T' the tube should be agitated so as to mix the metals further. Though we may hardly hope to saturate these two metals with each other for temperature T' , yet we may hope that at this temperature each will take up at least as much of the other as would suffice to saturate it at the lower temperature T .

The molten mass should now be cooled to T in the tube, and held there for say eight or ten hours, or as much longer as experience shows to be necessary. Should each metal have dissolved more of the other than corresponds to the saturation-point for T , each will tend now to expel this excess; and the object of allowing the temperature to remain stationary is both to allow the two alloys to separate into two distinct masses, and to perfect the separation of this excess by gravity.

As a convenient source of stationary temperature, we may use a vertical cylinder a little larger than the clay tube, heated by means of platinum wires themselves raised to incandescence by an electric current; lacking this, a bath of molten lead or other molten metal may be used. Great care must be exercised to keep

the different parts of the tube at the same temperature, lest convection currents interfere with the separation by gravity, and all agitation of the tube must be avoided.

In case either metal is liable to oxidize, a reducing atmosphere, or at least a neutral one, should be provided.

After allowing time for this separation by gravity, and with as little agitation as possible, the two ends of the columns of metal, which are the parts where separation should be most complete, should be cooled as rapidly as practicable, for instance, by holding "chills," *i. e.*, chilled pieces of iron against them. For this purpose the iron might previously have been cooled in a freezing-mixture. The object of this rapid cooling is to prevent the approach to equilibrium which has been reached at T from being disturbed by long exposure to any lower temperature in cooling.

Provision should be made for giving access to the upper and lower end of the tube so that the chills may be brought in contact with them without removing the tube from the furnace. To this end the upper section of the furnace may be movable, and the lower one may be provided with a suitable aperture.

After the whole has solidified and been thus cooled, borings from the two ends should be analyzed so as to give an approximation to the saturation-points. The ends should further be examined under the microscope, to see whether any particles of the excess dissolved at T' has failed to remove itself by gravity at T , and to obtain an approximate idea of the quantity of this excess.

This observation should enable us to apply a correction to the direct results of our chemical analysis.

The method here described is a modification of that of Dr. C. R. Alder Wright.*

114. THE COURSE OF SELECTION. TEMPERATURE-COMPOSITION-CURVE OF THE FROZEN CONTINENT DURING SELECTIVE FREEZING. — We have seen that the curve which represents the temperature and composition of the mother-metal during selective freezing, say of bismuth-bearing tin, is a fragment of one and the same line, whatever may be the initial composition. Thus if the molten alloy has composition q'' , Fig. 49, p. 136, this curve is a fragment of the line AB , beginning at q and running towards B . For molten alloy of composition w'' it is also a fragment of this

* *Proc. Royal Soc.*, XLV, pp. 465 and 471, 1889.

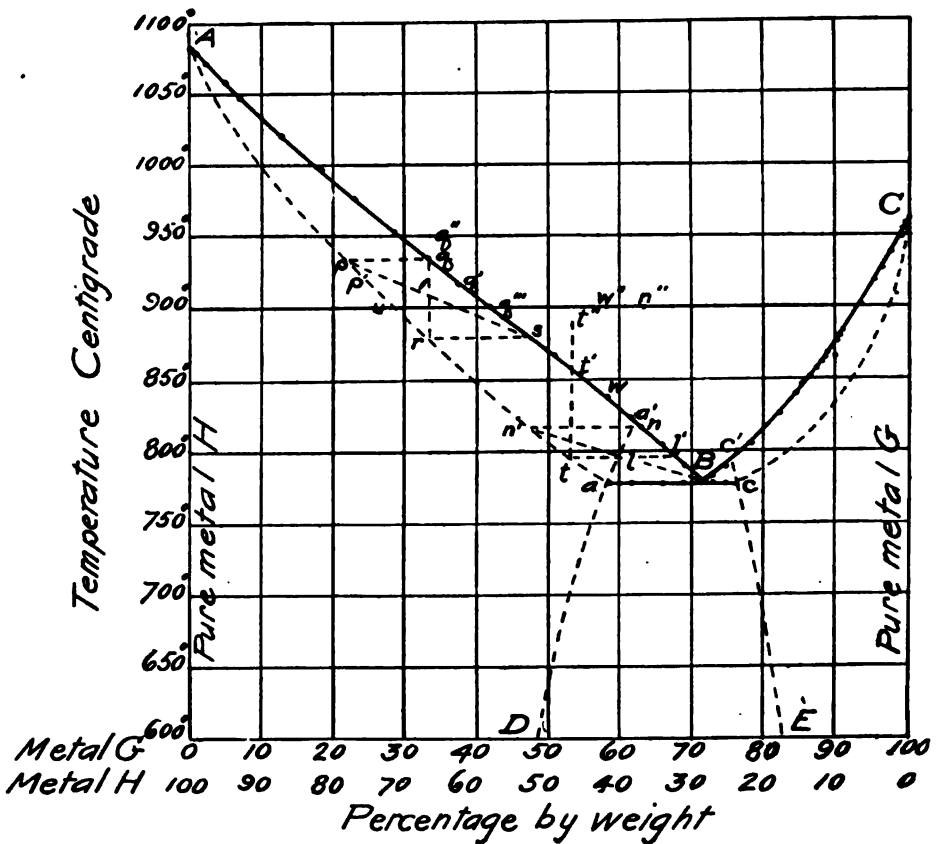

Fig. 49. Freezing-point and other Thermal Curves, Mainly Suppositious, of a Series of Alloys Eutectiferous in the Middle but not at the Ends.

The underscored V-curve, $ABCaBc$, is plotted by the author from the actual data of Heycock and Neville, *Phil. Trans. Roy. Soc.*, CLXXXIX, A, pp. 32-36, 1897, for the freezing-point curves of the silver-copper alloys. The other curves here given are purely conjectural.

The data of Heycock and Neville have naturally led many to believe that the eutectiferous region is the very short one between points a and c . The author knows of no series of alloys in which the eutectiferous region is so short. In general it extends much more nearly completely across the diagram. Actually Osmond found indications of a eutectic both in argentiferous copper containing only 1 per cent of silver and also in cupriferous silver containing only 1 per cent of copper. I have found a large quantity of what was undoubtedly eutectic in pure argentiferous copper containing 3.30 per cent of silver and 96.4 per cent of copper.

same line, beginning at w and likewise running towards B . For each initial composition, then, the temperature-composition curve of the mother-metal is some one fragment of this line AB ; and if we select initial compositions near enough together, manifestly their fragments of this line AB must overlap, and where they overlap they coincide.

The reason why it is a single line of which these several temperature-composition curves are simply fragments is a simple one. At each instant during selective freezing (assuming equilibrium) the mother-metal is at its freezing-point; and as the freezing-point for any given momentary composition of mother-metal is quite the same no matter what the initial composition of the molten mass was, so for each momentary composition of mother-metal one and the same point represents its temperature and composition no matter what the initial composition of the alloy. So too of any series of temperatures, *i. e.*, of any fragment of the freezing-point curve. If two alloys have initially so nearly the same composition that in freezing a certain part of the range of composition, through which the mother-metal of the first passes, overlaps part of the range of composition through which the mother-metal of the second passes, then at each temperature in that part which the two have in common each mother-metal must have the same composition as the other, since for each of them this composition is that for which this temperature is the freezing-point. But this is simply saying that where these two temperature-composition curves overlap they are identical. And so on for every other fragment of the line AB .

Now, always assuming that the conditions throughout are those of equilibrium, just as one and the same line AB is the temperature-composition locus for the mother-metal during freezing, for all initial compositions of the molten alloy between A and B , so there is a second line, Aa , Fig. 49, which is the temperature-composition locus for the part already frozen, the frozen continent, which line holds true for all initial compositions of the molten alloy between A and B . No matter what the initial composition of the molten alloy as a whole before freezing begins, the temperature-composition locus for the resultant frozen part is, during selective freezing, some one fragment of this line Aa . In short, as during selective freezing the composition and temperature of the mother-metal slide along the line AB towards

B, so simultaneously do the temperature and composition of the frozen part slide along *Aa* towards *a*. And, because the temperature of frozen mass and mother-metal are assumed to be identical, so the temperature-composition point for the frozen part must at each instant be the point on *Aa* having the same ordinate as the temperature-composition point on *AB* for the molten mother-metal, at that same instant; in short, at any instant the frozen-part point on *Aa* must be horizontally opposite the mother-metal point on *AB*.

Let us temporarily assume that the two extremities of this temperature-composition curve for the frozen part in equilibrium, are *Aa* for alloys at the left of *B* and *Cc* for alloys at the right of *B*. In § 118, p. 141, we shall see that this must be true.

These assertions, be it understood, assume that equilibrium exists. In particular the temperature is assumed to be absolutely uniform throughout the mass, both molten and frozen; and it is assumed that diffusion has completely effaced the heterogeneity which freezing sets up both in the solid and in the molten parts (Fig. 42, p. 96), so that the frozen continent has become uniform throughout in composition, and that the mother-metal also has. During freezing itself, the outer layers of the frozen part, those through which the heat escapes from the system, are cooler than the inner ones, and these in turn than the molten mother-metal. Manifestly this condition of equilibrium for any given temperature could be reached only by holding the temperature constant at that point until this equalization both of temperature and of composition could effect itself through diffusion and conduction, aided in the molten part by convection; in short, only by completely arresting the freezing and the removal of heat from the system. This condition of equilibrium, then, is one which would not actually be reached in any given freezing unless it were thus artificially arrested. But it is of importance as showing the condition towards which affairs tend.

115. REASONS FOR THIS CURVE. — How comes it, now, that the temperature-composition curve of the frozen continent is a fragment of one and the same line, no matter what the initial composition of the molten alloy is when it is all molten? Simply because, for given temperature and composition of the molten mother-metal, there is only one temperature and composition which the frozen part can have if, as we assume, it is to be in equilib-

rium with that mother-metal. The temperature of the two parts in any given case is clearly identical for equilibrium, since were one hotter than the other, heat would quickly flow from it to that other and continue flowing until they reached the same temperature. Hence the temperature-composition point representing the frozen layers must, at any given instant during freezing, be on the same horizontal line as the point representing the mother-metal.

And since the temperature-composition curve of the mother-metal during freezing is a fragment of one and the same line AB or CB , no matter what the initial composition of the alloy when it is all molten; and since for *any given point* on AB or CB represented at any moment during freezing there is only *one point* which can represent temperature and composition of a frozen part in equilibrium with the mother-metal at that point on AB or CB , no matter what the initial composition of the alloy; so there can be only *one series of points, i. e., one line*, which for equilibrium represents temperature and composition of the frozen part, *i. e., one line only corresponding to line AB for the molten part*, and only one line corresponding to the line CB . Just what the position of these lines is must be determined in each case; but that there is one line somewhere to the left hand of AB and one to the right hand of CB , representing the temperature and composition of the frozen part in equilibrium with the mother-metal represented by the horizontally opposite points on AB or CB , is thus clear on reflection.

116. TEMPERATURE AND COMPOSITION OF THE FROZEN PART AND THE MOLTEN MOTHER-METAL DURING SELECTIVE FREEZING.

NON-EUTECTIFEROUS ALLOY, METALS G AND H . — First let us, to fix our ideas, consider a specific case in Fig. 49, that of the alloy 32 per cent of metal G and 68 per cent of metal H , and let us assume that we begin cooling it slowly from say 950° , q'' . The alloy begins to freeze when the temperature falls to q (say 933°), and the very first layer to freeze out has composition p , horizontally opposite q , (here sketched by eye as 22 per cent G and 78 per cent H). This follows because this first smallest incipency of a flakelet may be considered as the smallest quantity which, in view of the size of the molecules themselves, can possibly exist; a quantity not infinitesimal but of the same order of size as the molecules themselves; in other

words, consisting of the smallest possible number of molecules, and therefore of uniform composition throughout. As regards the composition of the frozen part, equilibrium exists, as it clearly must whenever that frozen part is of uniform composition throughout. Thus, as regards the first particle to freeze out, we have only to assume uniformity of temperature, and the other conditions of equilibrium exist. This then places the first frozen particle at p without awaiting diffusion.

During the further fall say to q' (say 918°) a succession of layers will freeze out each richer in G than the preceding. If, now, the temperature is held constant at 918° until the diffusion of metal G in these different onion peels has completed itself, so that their composition has become the same throughout, and equilibrium has thus been reached, then as already pointed out, the composition of this frozen mass will be represented by the point p' on Aa horizontally opposite the point q' which represents the composition of the remaining molten mother-metal with which it is in contact.

Clearly, when the whole of the alloy has solidified and its composition has by diffusion become uniform, that composition must be the same as that of the original alloy when molten; for the frozen alloy is that same initial alloy simply changed from a homogeneous molten to a homogeneous solid, without adding to or taking away from its initial composition. Its composition, therefore, must be on the same ordinate as the initial composition, q'' and q ; and since, because it has now become homogeneous it is on Aa , it must be r , the point on Aa vertically under q'' and q .

If just before the very last flakelet froze, and when the molten mother-metal had thus been reduced to its smallest possible quantity, the temperature, which would now be substantially that of r , were held constant until the whole of the frozen mass became homogeneous through diffusion, so that its composition, following the reasoning in the last paragraph, had become substantially r ; then, since the composition of the mother-metal at any instant when the frozen mass has become homogeneous is the point on AB horizontally opposite the composition-point on Aa of the frozen part, the composition of this last particle of molten mother-metal must be the point opposite r , *i. e.*, it must be s .

In short, the temperature and composition of the mother-metal at the beginning and end of the freezing are q and s respectively, and those of the frozen mass p and r , of which p is horizontally opposite q , r vertically under q , and s horizontally opposite r .

117. BARELY NON-EUTECTIFEROUS ALLOY OF METALS G AND H . — Let us next consider the cooling of the molten alloy of composition w'' . This is on the same ordinate as a . But a is the western boundary of the eutectiferous range (see § 105, p. 121). In other words, it represents metal H exactly saturated when solid with G . Were the molten alloy to contain more of metal G than this, be that excess of G ever so small, that would supersaturate the freezing metal H , and consequently in the course of selective freezing the enrichment in metal G of the freezing layers would reach the saturation-point before the whole of the mother-metal had frozen; and the remainder of this mother-metal would in freezing split up into the eutectic (see § 64, p. 72). In short, our present alloy of composition w'' , from considerations with which we have already become familiar, is barely non-eutectiferous.

118. POSITION OF THE EXTREMITIES OF TEMPERATURE-COMPOSITION CURVE FOR THE FROZEN PART. — The temperature at which the freezing ends in case of any eutectiferous alloy, and of an alloy which is barely non-eutectiferous in the sense of being of the composition which exactly bounds the eutectiferous range, is the eutectic freezing-point, through which the line aBc runs. Such an alloy which bounds this range we may call a boundary alloy. If, now, such a boundary alloy is frozen, and, on reaching the lower freezing-point at which its freezing would end, it is held at stationary temperature until diffusion has completed itself, it will be wholly in equilibrium, and on this account it will be a point on the temperature-composition curve for the frozen part under conditions of equilibrium. Its temperature and composition will both be represented by point a . Hence point a , which represents the boundary of the eutectiferous-range and also the eutectic freezing-point, is one extremity of this curve.

Clearly the other extremity is the point A . For, if our initial molten mass is not an alloy at all but simply pure metal H , then when it freezes no selection can take place; throughout the freezing both mother-metal and frozen part are pure metal

H ; and also throughout the freezing the temperature is A . This point A , then, is one point representing equilibrium for both temperature and composition for both the mother-metal and the frozen part during freezing. It is the extremity of the temperature-composition curve for both molten mother-metal and frozen part, for alloys at the left of B .

So, *mutatis mutandis*, C and c are the extremities of this same curve for alloys at the right of B .

119. EUTECTIFEROUS ALLOY OF METALS G AND H . — Let us next consider the cooling from 900° of an alloy of 37 per cent of metal H and 63 per cent of metal G , represented initially by the point n'' . When the alloy in cooling reaches temperature n , say 818° , it begins to freeze, and the first frozen particle will have composition n' , horizontally opposite n on the line Aa , or say 52 per cent of H and 48 per cent of G . As the temperature further falls and freezing progresses the composition of the frozen part, assuming always that diffusion has made it homogeneous, will slide along Aa from n' towards a , while the composition of the remaining mother-metal will slide along AB from n towards B . When the temperature reaches B the frozen mass will have composition a , or say 42 per cent of H and 58 per cent of G , while that of the remaining mother-metal will have reached B , or 28 per cent H , 72 per cent G .

As the frozen mass at this instant contains only about 58 per cent of G , a , whereas the initial mass contained 63 per cent of G , n , it is evident that the difference between these two amounts must be represented by the existence of a still considerable quantity of mother-metal. Now begins the eutectic-freezing period.

Up to this point the freezing has been selective, *i. e.*, the layers freezing out have been richer in metal H than the mother-metal from which they freeze, so that this mother-metal has been growing continuously richer in metal G and hence more fusible. But at this point selection ceases for the reason already explained, that the mother-metal has now reached the composition of lowest freezing-point, and consequently no further selection can further lower the freezing-point. Hence the remaining mother-metal now freezes without selection, but in freezing splits up into a conglomerate of separate flakes of G saturated with H and of H saturated with G .

But as the mother-metal is now of the eutectic composition,

the conglomerate into which it now splits up will be the true eutectic, as we saw in § 74, p. 84. We have thus three bodies in this conglomerate: (1) the excess or previously frozen part, metal *H* saturated with metal *G*, saturated because we now are assuming that equilibrium has been reached; (2) the flakes of metal *H*, forming part of the eutectic, also saturated with *G* (§ 74, p. 84); and (3) the flakes of metal *G*, forming the remainder of the eutectic and saturated with *H*. Manifestly (1) and (2) cannot diffuse into or otherwise react on each other, because they are of identical composition; and (3) cannot diffuse into either of the others, for the reason given in § 73, p. 80. Hence, in short, the eutectic which forms through the freezing and splitting up of the mother-metal at temperature *B* remains as the eutectic, and is not absorbed into the previously frozen part.

This, as before, is on the assumption that the previously frozen part has become uniform through diffusion.

The fact that the composition of the mother-metal remains constant during the remainder of the freezing implies that the temperature at which the freezing now completes itself is constant; and this part of the freezing is therefore represented by point *B*.

During the eutectic-freezing period, the conglomerate of which the now frozen part consists is the saturated solid solution of *G* in *H* formed during the excess-freezing period, and called substance (1) above, which remains constant in quantity, plus a progressively increasing quantity of eutectic.

120. SUMMARY OF THE FOREGOING. — In short, in Fig. 49 the loci for temperature and composition are as follows:

	FOR THE MOLTEN METAL	FOR THE FROZEN PART
During the excess-freezing, or solid-solution generating, or selective period	<i>AB</i>	<i>Aa</i>
During the eutectic-freezing period.	<i>B</i>	<i>aB</i>

During the former period the frozen mass, assuming that diffusion completes itself, becomes homogeneous; during the latter it remains a conglomerate of (1) the eutectic and (2) the saturated solid solution of metal *H* saturated with metal *G*, the saturation of this solution preventing diffusion of the eutectic into it.

121. TEMPERATURE-COMPOSITION CURVE OF THE LAYERS IN THE ACT OF DEPOSITION. — We may represent graphically on this same diagram the temperature-composition locus of still a third entity, the layers in the act of depositing at any given instant, as distinguished from the average of the mass already frozen at such instant. Thus, starting as before with composition q'' , the first deposited layer has, as we have seen, composition p ; the last particle of mother-metal to freeze has composition s ; but the last layer to freeze must necessarily have the composition of the last particle of the mother-metal to freeze, since it is the latter which in freezing turns into the former. Hence the composition of the last frozen layer is s ; and the composition of the successive layers to freeze out will lie along the line ps , though as to the shape of this line nothing is here said. ps evidently corresponds to the part BC of Fig. 30, p. 71.

Note here a radical difference between these present curves and the other temperature-composition curves AB , CB , Aa , Cc and aBc . For whereas each of these latter five applies to a whole series of initial compositions, the curves for each of which are simply individual fragments of these five curves; the curve for the layers in the act of freezing is a different one for each initial composition.

122. THE SAME CURVE FOR A EUTECTIFEROUS ALLOY. — Taking now the case of an alloy so rich in metal G as to be eutectiferous, say with initial composition n'' , the first layer to freeze will as before have composition n' . The last layer to freeze will in this case be of eutectic composition B . But the temperature-composition locus should not be a simple one, $n'B$, as in case of our non-eutectiferous alloy q . With falling temperature the composition should indeed slide along $n'B$, but on meeting the saturation-point curve Daa' at l , further enrichment of the depositing layers should cease, for the reason that they have now become saturated with metal G . (See § 66, p. 73.) Henceforth their composition should simply be that of saturation, *i. e.*, with falling temperature it should slide along la until it reaches a , simultaneously with the arrival of the mother-metal at eutectic composition and freezing-point B . But that which henceforth freezes is simply the eutectic; so that the locus of the temperature and composition for the layers in the act of freezing is (1) from n' to l and (2) from l to a ; (3) it then leaps from a to B without

traveling along aB progressively. The progress from n' through l to a is per gradum, that from a to B is per saltum. This represents the abrupt demarcation of the eutectic which we find under the microscope.

123. CORRESPONDENCE BETWEEN THE COOLING CURVE AND THE TEMPERATURE-COMPOSITION CURVE OF THE FREEZING LAYERS. — Turning now to Fig. 31, p. 71, for a given initial composition n'' the correspondence between it and Fig. 49 is as follows:

	FIG. 31	FIG. 49
Excess-freezing period		
Subsaturation division	BB'	$n'l$
Saturation division	$B'C$	la
Eutectic-freezing period	CD	B

124. NO GAP IN THE SATURATION-POINT CURVE. — From the fact that between the lower boundary of the molten region of the freezing-point curve, ABC , Fig. 50, and the upper boundary, $AaBcC$, of the frozen region there is a pair of gaps, the triangles AaB and CcB , it might at first sight be thought that these triangles were a sort of no-man's land; that they belong neither to the molten nor to the solid state; hence that no alloys either molten or solid are really represented by them; hence, finally, that the saturation-point curves for the solid state should run only from D to a and from E to c , and that the intercepts aa' and cc' have no true existence and should be struck out, on the ground that it is unfair and misleading to draw curves representing the properties of non-existent substances.

But this is fallacious. The fallacy comes from ignoring the fact that $AaBcC$ is the boundary of the solid region only on the assumption that that region has become homogeneous through diffusion. But during diffusion alloys in these triangles come temporarily into existence, and these ephemeral alloys have naturally a definite solvent power, just as much as if they were permanent. Hence we are quite justified in drawing the parts aa' and cc' through these triangles. The fallacy then is in supposing that these alloys, because only ephemeral, do not exist.

That they do exist may be made clear by refreshing our memory as to what happens in the freezing of an alloy say of composition q'' , Fig. 49. Let us assume that only the last smallest particle of mother-metal remains unfrozen, and that equilibrium

has been established throughout. We have seen that, in this case, the composition of the already frozen part is substantially r , while that of the molten mother-metal is s . Let us now suppose that, through further removal of heat from this system, this last particle of mother-metal is deposited with composition s , upon the previously frozen part with composition r . Immediately the excess of metal G above ratio r in this last deposited layer begins diffusing back into the previously frozen layers, and continues (temperature and time permitting) until this flake like the rest of the mass reaches composition r . Now between the instant when this flake was deposited as s and this later time when it

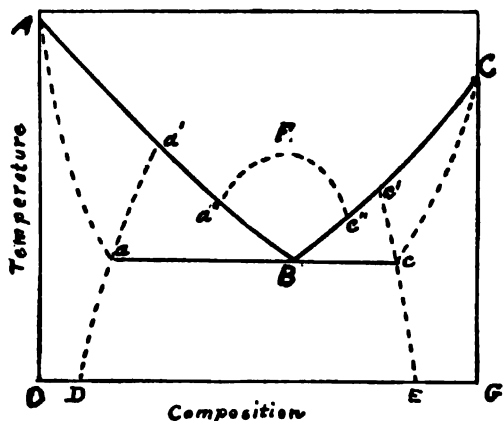

Fig. 50. Freezing-point and Saturation-point Curves.

reaches composition r through diffusion, it will have every composition intermediate between s and r . And in the same way every other point in the triangles AaB and CcB can be shown to have a real existence, even if a brief one.

Even the triangles $aa'B$ and $cc'B$ have a real existence. Thus, again assuming that equilibrium has been established, the last particle or flake to freeze from a molten alloy initially of composition l' (Fig. 49) will have composition l . When this flake freezes, it will split up into a flakelet of a saturated solid solution of G in H , and another flakelet of a saturated solid solution of H in G , simply because it lies within the saturation-point curve. (§ 108, p. 125.) (Note this distinction between this last deposited

flake as a whole, and the twin flakelets, of which it is composed, one a solid solution of G in H and the other a solid solution of H in G .) Let us call these flakelets G and H . As the earlier frozen part with which these flakelets are in contact is unsaturated with metal G (composition t), part of the metal G in the flakelet H will begin diffusing into this older part, shifting the composition of flakelet H to the left, and thus leaving it unsaturated with G . But we saw in § 108, p. 125, that any alloy within the saturation-point curve must (for equilibrium) consist of distinct particles of each metal saturated with the other. The fact that our flakelet H is unsaturated with metal G leaves it and its twin flakelet of H -bearing G out of equilibrium, which will reestablish itself by a readjustment of the G and H in these two flakelets into two new ones each saturated. The flakelet G will be smaller than before, in accordance with this diffusion of G into the older layers that has already occurred.

But the process which led to the first transfer of metal G from our flake of composition l' into the older layers will continue, and with it the composition of the flake as a whole will shift to the left. But this flake will continue to consist of two distinct flakelets until its composition crosses aa' at l , when the last particle of H -bearing G will vanish and we have only our remaining flakelet of G -bearing H . At l it will be saturated with G ; as its G continues diffusing into the older layers and the composition of our flakelet travels towards t , it becomes unsaturated; with further diffusion of G it gradually approaches and at last reaches composition t at the very time when the older layers reach that composition, by the complete equalization of the percentage of metal G throughout the different layers.* Thus every point between l' and l has a temporary existence; and so, by like reasoning, has every other point in the triangles $a'aB$ and $c'cB$.

* Through a like fallacy it might well be thought that the saturation division $B'C$ of the cooling curve, Fig. 31, had no true existence, because, according to the temperature-composition curves of the frozen layers, those layers reach saturation only at the moment when the eutectic begins to freeze.

But, like the fallacy already discussed in this section, this comes from confusing the composition of the frozen layers, after they have become homogeneous through diffusion, with the composition of the layers

CHAPTER VI.—COOLING CURVES AND FREEZING-POINT CURVES OF SERIES CONTAINING DEFINITE CHEMICAL COMPOUNDS

126. SERIES OF WHICH ONE ALLOY IS A DEFINITE CHEMICAL COMPOUND.—The copper and antimony alloys, Fig. 51, p. 150, lead us a step farther. These two metals form a definite chemical compound, antimonide of copper (Cu_3Sb_2), represented by the ordinate PA' ; so that the series of their alloys really consists of two parts, those in which copper is in excess over this ratio and those in which antimony is in excess over this ratio. If copper is in excess, as in the left-hand part of Fig. 51, we have in effect alloys of copper with antimonide of copper. If, as in the right-hand part of that figure, antimony is in excess, we have in effect alloys of antimony with antimonide of copper. We naturally expect a critical point in the freezing-point curve at the composition of this antimonide of copper, and indeed in the corresponding curves for the various physical properties, because a given addition of copper to copper-antimonide should produce an effect different from that which a like addition of antimony to the copper antimonide should cause. It so happens that each of the two series of alloys, copper plus copper-antimonide and antimony plus copper-antimonide, is eutectiferous, so that each series has its own eutectic. Thus taking the series of copper-antimony alloys as a whole it presents two eutectics, one rich in copper,

in the act of freezing. It is the composition of these latter layers thus removed out of the molten mother-metal which determines the rapidity of its enrichment. And, while it is quite true that the frozen layers, made homogeneous through diffusion, reach saturation at the time when the mother-metal reaches the eutectic composition and freezing-point; it is also true, as shown in Fig. 49, that the composition of the layers in the act of freezing, which must necessarily be intermediate between that of the already frozen mass and that of the mother-metal, must cross the saturation-point line Daa' before the mother-metal reaches B .

Indeed, it is because I have actually found that both these fallacies confused even intelligent post-graduate students, that it has seemed worth while to write the present section.

These fallacies show us how dangerous is the convenience of such graphical illustrations as that of the temperature-composition curves of the frozen layers made homogeneous. The student readily loses sight of the assumption on which alone these curves are true.

B , the other rich in antimony, B' . In any given alloy of course only one of these eutectics could be present. The eutectiferous alloys rich in copper, represented by the region aBc , contain the eutectic B rich in copper; while the eutectiferous alloys rich in antimony, represented by the range $a'B'c'$, contain the eutectic B' rich in antimony. (As usual, equilibrium is here assumed to exist.)

Taking four typical alloys at random, those containing 20, 38, 60 and 80 per cent of antimony respectively, their constitution would be as follows:*

PER CENT ANTIMONY	EUTECTIC	EXCESS-METAL
20	B , Copper and copper-antimonide	Copper (containing antimonide dissolved in it)
38	B , Copper and copper-antimonide	Copper-antimonide (containing copper dissolved in it)
60	B' , Antimony and copper-antimonide	Copper-antimonide (containing antimony dissolved in it)
80	B' , Antimony and copper-antimonide	Antimony (containing copper-antimonide dissolved in it)

127. SERIES OF WHICH SEVERAL MEMBERS ARE DEFINITE CHEMICAL COMPOUNDS.—The case of gold-aluminium alloys is still more complicated, for there is evidence tending to show that gold and aluminium form no less than five different definite chemical compounds. Hence the complexity of their freezing-point curve, Fig. 52. These alloys are of special interest from the fact that one of them, $AuAl_2$ (H), a purple alloy discovered by Sir William Roberts-Austen, is not only much more infusible than the mean of gold and aluminium, but has a melting-point very close to that of gold.†

* Roberts-Austen and Stansfield, *Rapports Présentés au Congrès International de Physique, Réuni à Paris en 1900*, I, p. 394, Fig. 19. A. Stansfield, private communication, January 31, 1902.

The matter is complicated still farther by the fact that some of the alloys rich in copper undergo after solidification the transformations represented by the line cc_1 , a complication which, to simplify our present study, we may leave out of consideration.

† There is a prevalent belief that the melting-point of an alloy is always below the mean of the melting-points of the constituent metals. This, however, is not necessarily true. Indeed some alloys have a melting-

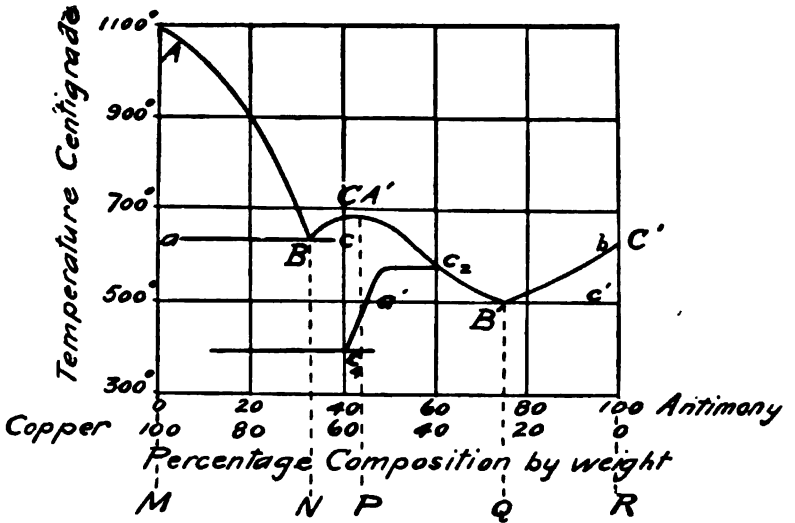

Fig. 51. Freezing-point Curve of Copper-antimony Alloys.

Roberts-Austen and Stansfield, *Rapports Présentés au Congrès International de Physique Réuni à Paris en 1900*, I, p. 394, Fig. 19.

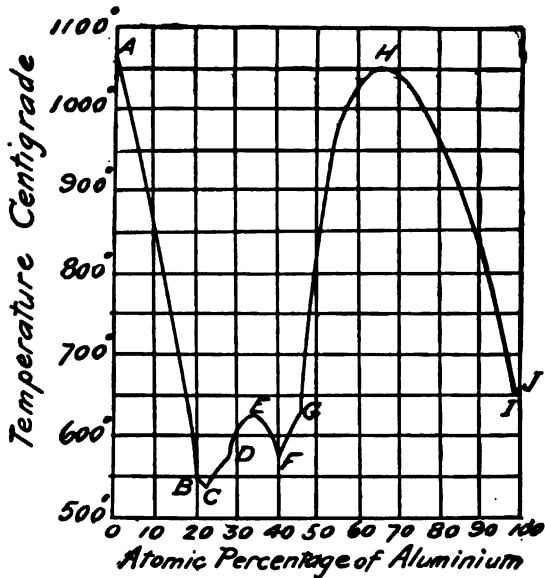

Fig. 52. Freezing-point Curve of the Gold-aluminium Alloys.

Heycock and Neville, *Phil. Trans.*, 194 A, p. 201, 1900.

In still other cases, the definite chemical compound which two metals form may itself form a eutectiferous series with one of those metals, but a non-eutectiferous or solid-solution series with the other. The freezing-point curve of the former series, occupying one end of the diagram, should be of the familiar underscored V-shape, while that of the latter covering the other end of the diagram should be smooth; so that the diagram as a whole should have the general shape shown in Fig. 53.

128. MEANING OF SUPERIOR ANALYSIS. — We can now see what is meant by saying that the study of the constitution of alloys, for instance by means of their freezing-point curves, gives us a method of superior analysis. For instance, if one

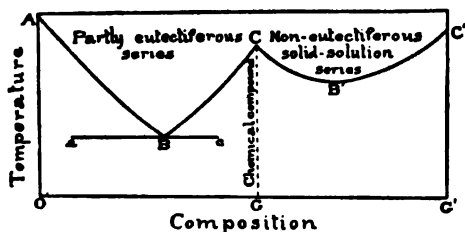

Fig. 53. Supposititious Freezing-point Curve of a Series Containing a Definite Chemical Compound and Eutectiferous at One End but not at the Other.

should determine the cooling curves of pure lead, pure tin and the lead-tin alloys with say 20, 50, 70, and 90 per cent of tin, and should plot from their freezing-points the freezing-point curve of the series, he would find that it was of the family of Fig. 24, and he would at once have ground to believe that they formed a single series, eutectiferous through at least most of its length, and free from any definite chemical compound. Examining a similar series of gold-silver alloys he would have ground to believe that they formed throughout a solid-solu-

point higher than that of either of the constituent metals. Thus C. R. Alder Wright reported in 1892 that, in case of the alloys of antimony and aluminium, "with certain proportions alloys are formed exhibiting melting-points much above those of either antimony or aluminium." (*Jour. Soc. Chem. Indus.*, XI, 493, 1892.)

tion series of alloys. And in the case of copper-antimony alloys he would similarly, from the mere inspection of the freezing-point curve, infer the general plan of constitution described in § 126, p. 148. In the first and the third case the direction of the V-shaped branches would indicate approximately the composition of the eutectic or eutectics, and in the third case the composition of the definite compound. Here then are the critical points indicated approximately by a very few and very easy observations. The investigator is in a position to "throw himself on the hinge," and examine immediately the alloys at and near these critical points, for these are the ones which are likely to have the maxima or minima of the various useful properties.

CHAPTER VII.—VARIATIONS IN ELECTRIC CONDUCTIVITY AND OTHER PROPERTIES OF SERIES OF ALLOYS

129. ELECTRIC CONDUCTIVITY. — While the manner in which the other properties, for instance, the electric conductivity, of a series of alloys, vary from one end of this series to the other at the room-temperature, in short the electric-conductivity-composition curve, also may throw light on the constitution of the alloys of that series, yet its indications are far less instructive than those of the cooling and freezing-point curves, *i. e.*, of our thermal study. These latter tell us the history of each individual alloy as it traverses a long range of temperature, and record each birth and transformation within it; while the electric-conductivity-composition curve for given temperature gives simply the conductivity of the cold alloy, (giving if this is composite the average conductivity of its constituents) with no suggestion of the genesis of those constituents.

But were our study of electric conductivity parallel with our thermal study, it should give indications of great value. Le Chatelier has already used this method.* Let me explain my meaning. Instead of determining simply the conductivity in the cold of several different alloys of a given series, let us fol-

* Le Chatelier, "Sur la Résistance Électrique des Alliages" (*Contribution à l'Étude des Alliages, Commission des Alliages, 1896-1900, p. 413*).

low for each of those alloys the variations in conductivity which occur as it cools from the molten state downwards to the cold. With a pair of autographic galvanometers, one recording time and temperature, *i. e.*, the cooling curve, and the other recording simultaneously time and conductivity, we should have two records of the genesis of each constituent of the alloy, one the thermal effect of that genesis, the other the variation in electric conductivity which the birth of the little stranger introduces. Then from these two sets of curves we should plot a general diagram on the principle of the freezing-point curve, with temperature as ordinate and composition as abscissa, drawing on this, as on our freezing-point curve, the loci of the critical points in the temperature-conductivity curves.

The principle of such an autographic arrangement is extremely simple. The beam of light from the galvanometer mirror moves to the right and left in a horizontal plane, following, if the galvanometer indicates temperature, the varying thermo-electric power, *etc.* To obtain an autographic record of these deflections of the galvanometer it is simply necessary to focus the beam of light upon a photographic film moving in the vertical plane. This film may be rolled on a cylinder, the axis of which is at right angles with the beam of light; or, as is in my opinion better, it may be on a photographic glass plate, the surface of which is normal to the beam of light, or more accurately, to the beam in its position of mid-travel. The plate of glass moves vertically, and the resultant of this vertical motion together with the horizontal motion of the beam of light is a curve, for instance a cooling curve, every inflection of which indicates a variation in the thermo-electric current passed through the galvanometer, due in turn to a variation in the rate of cooling of the substance under observation.

In order that the value of our results should approach that of our thermal study, the range of temperature covered by our conductivity determinations should start from a point above the freezing-point of the alloy, and should include the whole range of freezing in addition to the range between this and the room-temperature, because it is in the freezing-range that most of the constituents of our alloys come into existence. To determine the conductivity of molten and of solidifying alloys would not be easy; but the difficulties are not insuperable.

130. THERMO-ELECTRIC POWER. — This same method should apply with great ease to the study of thermo-electric power. Here as before, with two autographic galvanometers we should get at the same time (1) cooling curves, telling us of the thermal effect of each transformation, and (2) thermo-electric-power-time curves; and from these we should construct thermo-electric-power-temperature curves, telling us how the products of the several transformations differ in thermo-electric power. Then as before, constructing a diagram with temperature as ordinate and composition as abscissa, and drawing on it the loci of the critical points for thermo-electric power, we should have a reinforcement of the teachings of the freezing-point curve.

The value of this method for thermo-electric-power study is of course limited by the fact that it must stop short of the temperature at which the alloy studied reacts chemically on the metal used as the other member of the thermo-electric couple. How serious this limitation would be remains to be seen. Where it confines us to temperatures below the lower freezing-point, the limitation would be very serious, because it would exclude us from a most important critical range. But for the study of transformations which, like those of iron and steel, occur within the solid metal well below the freezing-point, the method should be of very great value.

Each of these methods promises a rich and easily won harvest.

The same is true of the coefficient of dilatation, in the study of which Le Chatelier has already reached important results.*

131. ELECTRIC CONDUCTIVITY AT THE COMMON TEMPERATURE. — Returning to the electric conductivity of the cold alloys, a word may not be amiss as to the way in which it varies throughout different classes of series of alloys. This subject will be treated in §§ 132 to 135, pp. 154 to 159.

132. SOLID SOLUTIONS. — If all the alloys of the series, say of gold with silver, were to consist of solid solutions, of silver in gold or gold in silver, then since the properties of our familiar liquid solutions in general vary progressively and without abrupt

* Le Chatelier, "Sur les Propriétés des Alliages" (*Contribution à l'Étude des Alliages, Commission des Alliages*, 1896-1900, p. 387).

changes or critical points as the degree of concentration increases, *i. e.*, as we pass from one end of the series to the other; so here we should expect the electric-conductivity curve to be a smooth one throughout, without inflections or critical points; and this Matthiessen found to be the case. (Fig. 54.)

133. SERIES EUTECTIFEROUS THROUGHOUT.—But what shape of electric-conductivity curve should we expect in case two metals are absolutely insoluble in each other? Let us for the moment assume that this is true of lead and tin; then every alloy of these two metals would when cold consist of a eutectic plus crystals of pure lead or pure tin, according to which of

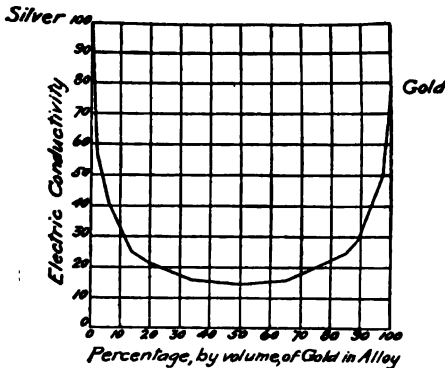

Fig. 54. Electric Conductivity Curve of the Silver-gold Alloys. Matthiessen, *Rept. British Assoc.*, XXXIII, p. 46, Pl. V, 1863.

these two metals was in excess over the eutectic ratio; and the eutectic itself would consist of interstratified plates of pure lead and pure tin. The current in crossing such an alloy would have to cross in effect simply a mechanical mixture of the crystals of pure lead and pure tin, and were there no breaks of continuity the conductivity of the whole should be the mean of that of pure lead and pure tin. This inference should not be affected in the least by the fact that certain of these crystals are grouped together in the form of the eutectic, which for our present purpose is simply a special form of mechanical mixture. In short, the electric-conductivity curve should be a straight line, and this Matthiessen found it to be for the lead-tin and for several other groups of alloys. (Fig. 55.)

But unless we were quite sure that the conductivity curve was really a perfectly straight line, it would not tell us whether the alloys were solid solutions or mechanical mixtures, because the electric conductivity of the solid solutions of two metals in each other might differ only very slightly from the mean conductivity of those metals, and indeed might be exactly that mean; in other words, the smooth electric-conductivity curve of a solid-solution series of alloys might deviate only very slightly from a straight line, and conceivably could be exactly a straight line. Here then the teaching is inconclusive.

134. SERIES OF LIMITED MUTUAL SOLUBILITY: BISMUTH-TIN TYPE, PARTLY EUTECTIFEROUS. — We have seen in § 60, p. 68, and Fig. 49, p. 136, that these series, while eutectiferous in

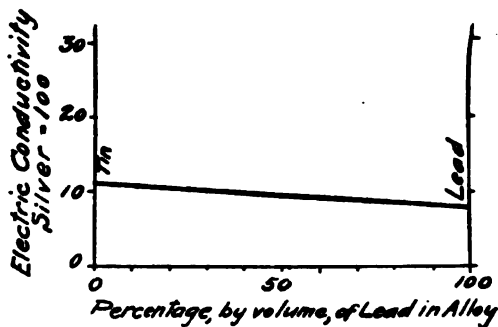

Fig. 55. Electric Conductivity Curve of the Lead-tin Alloys. Matthiessen, *Rept. British Assoc.*, XXXIII, p. 46, Pl. V, 1863.

the middle, are solid solutions at their ends. The copper-silver alloys belong to this general class, but the solid solution part of the range is very short. Apparently all argentiferous copper containing more than about 1 per cent of silver and all cupriferous silver containing more than about 1 per cent of copper are eutectiferous. The electric-conductivity curve of this series, Fig. 56, appears to reflect the solid-solution part of the series by the smooth curve or nearly straight line at either end of the diagram. Moreover, Fig. 31, p. 76, shows us that in the eutectiferous part of the diagram, the successive layers of such alloys, taken at the moment of their deposition, consist of (1) an unsaturated solid solution progressively approaching sat-

uration, so that each layer in it contains a larger proportion of the dissolved metal than the preceding layers (part BB'), plus (2) a saturated solid solution, the composition of which should vary slightly from layer to layer as, with the fall of temperature, the saturation-point gradually shifts (part $B'C$), plus (3) the eutectic (part CD). And, if part of each of these three divisions persists, *i. e.*, if diffusion has failed to efface this initial heterogeneity but has left part of it, then the electric-conductivity curve, even in the eutectiferous region of the diagram, need not be a straight line, but might have a critical point at the eutectic composition. For as we pass to the left of this point we have

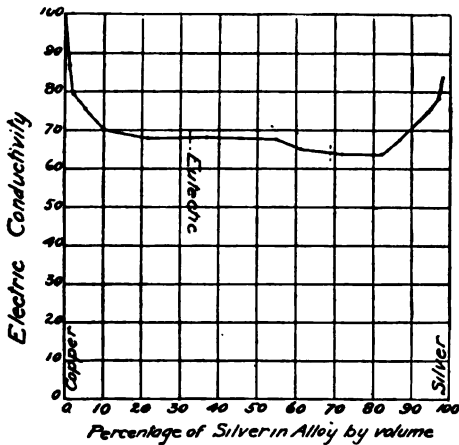

Fig. 56. Electric Conductivity Curve of Silver-copper Alloys.

Matthiessen, *Phil. Trans. Royal Soc.*, CL, p. 170, 1860.

the eutectic plus (1) a saturated and (2) a progressively varying solid solution of copper in silver, for which, at the right of the eutectic, like solutions of silver in copper are substituted. Thus we have two excess-substances at either end, if diffusion has not effaced the initial heterogeneity. Now clearly the progressively increasing quantities of these solutions of copper in silver on the left should affect the electric conductivity differently from like quantities of like solutions of silver in copper on the right; hence the lines at right and left of the eutectic should be differently inclined; hence in short, at the eutectic composition there should be a critical point.

For like reasons there might be critical points between the non-eutectiferous end-parts of the curve, and the eutectiferous range; and this latter range might itself be curved, and indeed a complex curvature may be expected, since each of the two excess-substances, the saturated and the unsaturated solid solutions at either end, may be of variable composition and quantity.

In view of this complexity it is small wonder that the conductivity curve, Fig. 56, tallies poorly with the constitution as we have actually learned it by means of the microscope, and that the teachings of conductivity in general in the cold are of little value compared with the story which the microscope and the cooling and freezing-point curves tell.

135. SERIES OF WHICH ONE MEMBER IS A DEFINITE CHEMICAL COMPOUND. — As pointed out in § 126, p. 148, such a series

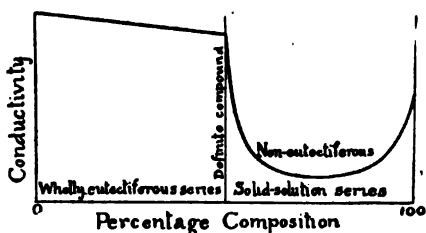

Fig. 57. General Shape of Electric Conductivity Curve of a Series of Alloys of two Metals, of which series one member is a definite chemical compound, which in turn forms with one metal a wholly eutectiferous series of alloys, and with the other metal a solid-solution series.

as a whole really consists of two distinct series, (1) metal *A* plus this definite compound and (2) metal *B* plus this compound. Each of these series should have its own distinct diagram, the shape of which should be governed by the principles just explained; and there should be a critical point at the composition of the definite compound, *i. e.*, at the junction of the two diagrams. Thus, if both series are eutectiferous from end to end, each diagram should be a straight line, and the diagram of the whole should be two straight lines meeting at a critical point, the composition of the definite compound. If both are solid solutions, each should have a smooth curve, and as before these curves should meet at a critical point, the composition of the definite compound. If one series consisted of solid solutions

and if the other series was eutectiferous throughout, the curve should be of the shape shown in Fig. 57; *etc., etc.*

We have now seen (§§ 131 to 135, pp. 154 to 159) the several different families of composition-conductivity curves which should accompany the different types of constitution.

Conversely, on finding the shape of the conductivity curve of a new series of alloys, we may apply like reasoning, and deduce the probable constitution of the series; which we then proceed to verify with the microscope. How close correspondence will actually be found remains to be shown.

136. OTHER PROPERTIES. — It requires little reflection to see that what has been said as to the curves of electric conductivity may be expected to apply to those of thermal conductivity, hardness, density, dilatation and many other properties.

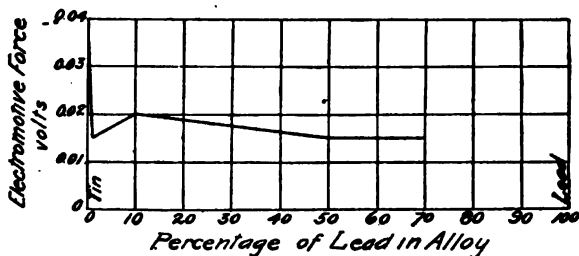

Fig. 58. Electromotive Force of the Lead-tin Alloys.
Laurie, *Journ. Chem. Soc.*, LV, p. 677, 1889.

137. ELECTROMOTIVE FORCE. — For the same reasons as in the case of the other physical properties, the electromotive-force curve should be a smooth one if the two metals form a solid-solution series of alloys with each other. But if the solid alloys are eutectiferous there is an obvious reason why the curve should be of a very different family.

The lead-tin alloys, for instance, may be regarded as mechanical mixtures of sheetlets of lead and of tin, in the form of the eutectic plus sheetlets of the excess-metal (see § 48, p. 62). If now we determine the electromotive force of these alloys in a slightly acid stannous chloride solution, using a sheet of the alloy as one pole and a sheet of lead coated with lead chloride as the other pole, then, since only the sheetlets of tin in the alloy should cause electromotive force, and since the sheetlets of lead should be inert, the electromotive force should be the same whether the

lead electrode, and not on the extent of surface offered by those alloy contained much or little tin, since it depends on the difference of potential between the tin sheetlets in the alloy and the sheetlets. And such is the electromotive-force curve of these alloys found by Laurie (Fig. 58).*

CHAPTER VIII.—THE METALLOGRAPHY OF IRON AND STEEL

138. INTRODUCTION.—Let us first survey in a general way the different classes of iron and steel, their constitution, and their properties. Let us next consider the genesis of that constitution, and in Chapter IX the correspondence between the changes in that constitution, *i. e.*, the transformation in the solid metal, and the prominent methods of heat-treatment.

139. GENERAL SURVEY.—What are the iron and steel of commerce and industry? Examined under the microscope they prove to be composite or granitic substances, intimate mechanical mixtures or conglomerates of microscopic particles of certain quite distinct, well defined, simple substances, in widely varying proportions. The structure of these conglomerates is of the type shown in Fig. 1, p. 3.

The chief of these substances are,

(1) pure (or nearly pure) metallic iron called *ferrite*, soft, weak, very ductile, with high electric conductivity, and in general like *copper* in its qualities, color excepted,

(2) a definite iron carbide, Fe_3C , called *cementite*, which is harder than *glass* and nearly as brittle, but probably very strong under gradually and axially applied stress.

* We may regard these alloys as mixtures not of chemically pure lead and tin, but of sheets of slightly plumbiferous tin and of slightly stanniferous lead. From the drop of electromotive force as we pass from pure tin to tin containing one per cent of lead, and the substantial horizontality of the curve to the right of this (for the deviation appears to be well within the limits of experimental error), it appears that one per cent (or perhaps even less) of lead suffices to saturate tin; so that the composition and hence electromotive force of the sheetlets of tin is independent of the total quantity of lead present provided this reaches one per cent, or the perhaps smaller quantity needed to saturate the tin.

Take immediately as the most important fact, the most essential part of the skeleton about which the various phenomena are to be grouped, that the great classes of iron and steel of chief value to the engineer and probably to the world at large, are essentially intimate mixtures or conglomerates of these two strikingly different microscopic constituents, ferrite extremely soft and ductile, cementite extremely hard and brittle, the former like copper, the latter like glass. The properties of several of the classes may indeed be influenced, and very profoundly, by thermal and mechanical treatment, and by the presence in certain of them of slag or of graphite; but the fact on which our attention should be concentrated at first is this, that the difference in properties between the different industrial classes of iron and steel are due chiefly to differences in the ratio which the ferrite bears to the cementite.

What has just been said does not apply, it is true, to what is called "hardened steel," which consists not of ferrite and cementite but essentially of austenite, as will be explained shortly; but it does apply to the great industrial classes of wrought iron and of steel such as ship, rivet, fencing-wire, tube, rail and tin-plate steel, and indeed all structural steels whether for plates, beams, eye-bars, angle-irons or any like object.

The steels which are especially soft and ductile, *e. g.*, the rivet and boiler-plate steels, consist chiefly of the soft, ductile, copper-like ferrite, as do those with very high electric conductivity, such as telegraph and telephone wires. In these steels the proportion of cementite may not exceed one per cent of the whole, the rest consisting almost wholly of ferrite.

The harder steels like rail steels, which are called upon to resist abrasion, *e. g.*, the grinding action of the car-wheels intensified by the presence of sand between wheel and rail, have a much larger proportion of cementite. About 93 per cent of their total mass is made up of ferrite and the remaining 7 per cent consists of cementite. This quantity of cementite suffices to increase greatly the resistance to abrasion, while the loss of ductility which it causes, though very marked, is not dangerously great.

Naturally, as the proportion of cementite in steel increases and that of ferrite decreases, the ductility diminishes continuously and the hardness increases continuously; the tensile strength,

however, reaches a maximum when the cementite amounts to about 15 per cent of the whole, and the ferrite is about 85 per cent; with further increase of cementite the tensile strength again decreases. These facts are sketched roughly in Fig. 59. The lines in this figure are intended only to give a sort of bird's-eye view of the subject, because, for given constitution, the properties vary very greatly with the treatment which the metal has undergone. Indeed, in case of hardness trustworthy quantitative data are not at hand.

The constitution of steel is not in general reported in the percentages of ferrite and cementite; nor, indeed, are most engi-

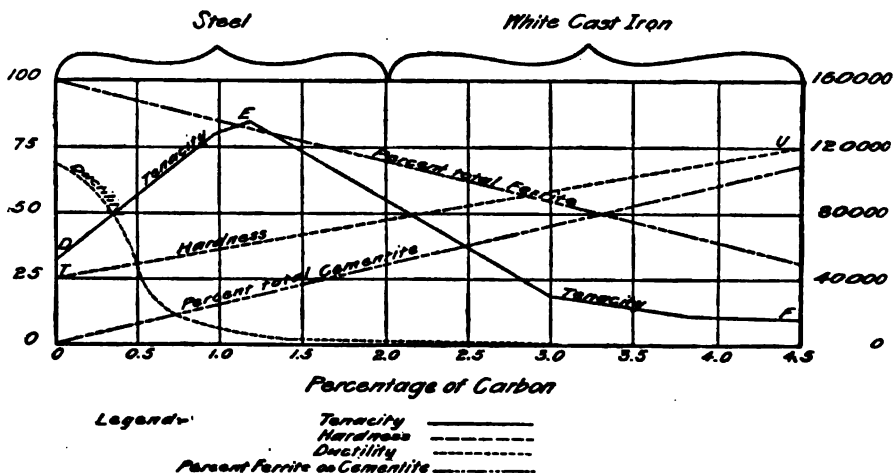

Fig. 59. Physical Properties and Assumed Microscopic Constitution of the Pearlite Series, Graphiteless Steel Slowly Cooled, and White Cast Iron.

NOTE.—By "Total Ferrite" is meant both that which forms part of the pearlite and that which is in excess of the pearlite, taken jointly. So with the "Total Cementite."

neers and metallurgists of to-day sufficiently familiar with this aspect of the subject to speak of it with confidence. But this is the aspect which the practitioners of the near future must face, and it is also that which enables us to understand the relation between the composition and properties of these different classes of iron and steel. Instead of saying that a certain kind of steel, for instance rail steel, contains so much cementite and so much ferrite, it is customary to report simply the carbon which that

cementite represents. For instance, instead of saying that rail steel contains about 7.5 per cent of cementite and nearly 92.5 of ferrite, we habitually and for convenience say that it contains about 0.50 per cent of carbon, which is the quantity represented by the presence of 7.50 per cent of cementite. (For the calculation on which this statement is based see § 153, p. 182.)

Besides these two constituents of prime importance, ferrite and cementite, there are three others of moment; these are graphite, slag, and austenite.

Graphite: Gray Cast Iron. — Graphite is an important constituent of cast iron, especially of gray cast iron, but for our present purpose we may regard it as either absent from steel or, if present, only in unimportant quantities.

Gray cast iron, the only kind of cast iron which can be widely used by engineers, may be regarded as a conglomerate of the second degree; for it consists first of a mechanical mixture of ferrite with cementite quite as steel does; while through this mixture as a matrix* there is scattered much free carbon in the form of sheets of graphite as shown in Fig. 60, p. 164. A weak, foreign body like graphite of course both weakens and embrittles the mass taken as a whole; hence the weakness and brittleness even of gray cast iron.

The graphite itself is pure or very nearly pure carbon in very thin, flexible sheets, which form a more or less continuous skeleton running through the mass of gray cast iron. It appears to be identical with the native mineral graphite (black lead, plumbago).

White cast iron typically would consist of cementite and ferrite quite as structural steel does, but with a much larger proportion of cementite, rising even to 67 per cent (say 4.50 per cent of carbon). Hence the extreme hardness and brittleness of this class of cast iron, so extreme as to exclude it from most engineering uses. But most of the white cast iron of commerce has a constitution intermediate between this extreme type on one hand and gray cast iron on the other; it contains much more cementite than gray cast iron and much less graphite. It is then, like gray cast iron, a conglomerate of the second degree, consisting first of a metallic matrix which is itself a conglomerate

* For meaning of "matrix" as here used see Appendix, § 327.

of much cementite with a variable proportion of ferrite, and second of a small quantity of graphite interspersed through this matrix.

Slag: Wrought Iron. — Wrought iron consists essentially of a metallic matrix identical with low-carbon steel, in which is mechanically mixed a small quantity of slag, a silicate of iron; this slag is not unimportant, yet it is far less important than the ferrite and cementite of the matrix.

Austenite: Hardened Steel. — Steel hardened by sudden cooling from a red heat consists essentially of austenite, a solid solution of carbon in iron of varying degrees of concentration (see



Fig. 60. Gray Cast Iron, cast in sand. Silicon, 1.54 per cent; Sulphur, 0.075 per cent (Sauveur, *The Metallographist*, III, p. 156).

§ 149, p. 179). When austenite contains as much as one per cent of carbon it is intensely hard and brittle; and indeed its hardness and brittleness are roughly proportional to the quantity of carbon which it contains. Hence steels for purposes which require extreme hardness, such as files and other tools for cutting metals and even wood, have from about 0.75 to 2.00 per cent of carbon, enough to give the degree of hardness required for the special purpose, but not enough to cause a prohibitory degree of brittleness; and they are "hardened" by sudden cooling.

Besides the cutting tools, armor-plate and projectiles are habitually made of hardened steel, and therefore consist essen-

tially of austenite. Thus the austeniferous steels are of importance, at least when contrasted with the non-ferrous metals; but the quantity of austeniferous steel in actual use is but an insignificant fraction of the non-austeniferous, that which consists essentially of ferrite and cementite.

On a general diagram or map of the iron-carbon compounds, such as Fig. 68, p. 194, each of these constituents has its normal or indigenous region, with limits of carbon-content east and west, and limits of temperature north and south. Certain of these limits are as yet imperfectly established, and indeed for certain of these territories the normal constituents have not been determined with certainty. Further, these constituents are somewhat vagrant, and often stray far beyond their indigenous region, or rather their theoretical habitat. Nevertheless, this map, which we owe chiefly to Roberts-Austen, Osmond and Roozeboom, aids indispensably in studying this whole question. No student can be said to have a good understanding of iron metallurgy who has not mastered its general outlines.

Table 7, p. 186, gives an approximate idea of the constitution of these various classes of iron and steel.

Heat-treatment.—As has been mentioned in passing, the properties of certain classes of iron and steel are influenced very greatly by thermal treatment. While this appears to act (1) in part by changing the size and arrangement of the microscopic crystalline grains of which the conglomerate mass consists, and probably (2) in part by inducing allotropic changes in the iron proper, yet (3) a very large part of its influence is through shifting the condition of the carbon between the three states of cementite or iron carbide (Fe_3C), austenite or solid solution of carbon in iron, and free carbon or graphite. In view of this latter mode in which heat-treatment affects the properties of the metal, it is but natural that its influence should in general be the more pronounced the more carbon the metal contains. Thus wrought iron and the very low-carbon steels containing from 0.06 to 0.10 per cent of carbon are in general but little affected by heat-treatment; while the high-carbon steels are influenced most strikingly. Cast iron, too, may be affected very greatly by heat-treatment.

Alloy steels, such as nickel, manganese, tungsten, chrome and molybdenum steel, have important specific qualities which

collectively are of importance; but their importance is secondary to that of the great classes which have already been outlined.

To recapitulate, the essential distinction between wrought iron and steel is that the former necessarily contains a small quantity of slag, which the latter lacks. The great and striking distinction between steel and cast iron is that the former contains less carbon than the latter; the boundary between them may be put roughly at two per cent of carbon.

Having thus taken a sort of bird's-eye view of the subject, we may now take up some of the special points in much greater detail.

TABLE 4. — *General Classification of Iron and Steel.*

		With Very Little Carbon	With a Moderate Amount of Carbon	With Much Carbon
Slag-bearing or Weld-metal Series		WROUGHT IRON	<i>Weld Steel</i> <i>Puddled Steel</i> <i>Blister Steel</i>	
		PUDDLED IRON BLOOMARY OR CHARCOAL IRON		
Slagless or Ingot-metal Series	Normal or Carbon Group	<i>Soft Steel or Ingot Iron</i> <i>Bessemer Open Hearth Crucible (Mitis)</i>	MALLEABLE CAST IRON	
	Alloy Group		<i>Half-hard and Hard Normal or Carbon Steel</i> <i>Bessemer Open Hearth Crucible</i>	NORMAL CAST IRON WHITE, MOTTLED, GRAY, SILVERY, WASHED-METAL
			<i>Alloy Steels</i> <i>Nickel Steel</i> <i>Tungsten Steel</i> <i>Manganese Steel</i> <i>Chrome Steel</i> <i>Silicon Steel</i>	ALLOY CAST IRONS FERRO-TUNGSTEN FERRO-MANGANESE FERRO-CHROME FERRO-SILICON SILICO-SPIEGEL
Per Cent Carbon		0 to 0.3	0.3 to 2.0	2.0 to 4.5 to 6.0

NOTE. — In order to make this table clearer, a special type is used for each of the three great classes, wrought iron, steel and cast iron. The wrought iron is given in Roman capitals, all the different varieties of steel in Italics, and all the different varieties of cast iron in Roman small capitals.

140. GENERAL CLASSIFICATION OF IRON AND STEEL. — Table 4 shows the different important varieties of iron and steel. They may be divided (1) according to the presence or absence of slag into (A) the slag-bearing or weld-metal and (B) the slagless or ingot-metal series; (2) according to their carbon-content into (A) low-carbon steel and wrought iron, (B) higher carbon steel and (C) cast iron; (3) according to whether their properties are due chiefly to their carbon or to some other element, into (A) the normal or carbon and (B) the alloy steels and cast irons; and (4) according to the method of manufacture, into (A) Bessemer, (B) open-hearth steel, *etc.*

Of these four bases of classification the second, carbon-content, is decidedly the most important.

141. DIVISION INTO THREE GREAT CLASSES ACCORDING TO CARBON-CONTENT. — Thus divided there are three great classes, which are as follows:

(1) with less than 0.30 per cent of carbon, called *soft* or *low-carbon steel* when free from slag, and *wrought iron* when containing slag; soft, ductile and relatively weak (tensile strength say 50,000 to 80,000 pounds per square inch in case of steel), *i.e.*, weaker than the second class, higher carbon steels, yet far stronger than cast irons, and with relatively little hardening power. (§ 139, p. 164),

(2) with between 0.30 per cent and 2.00 per cent of carbon, called *medium* and *high-carbon*, or *half-hard* and *hard steels*, harder, less ductile, and stronger than the low-carbon steels, more ductile and far stronger than the cast irons, and with marked hardening power. The tensile strength generally lies between say 80,000 and 130,000 pounds per square inch. The hardness and hardening power increase, and the ductility diminishes as the carbon increases, in each case apparently without limit; while the tensile strength increases with the carbon-content till this reaches about 1.00 or 1.20 per cent, and then again decreases,

(3) with more than 2.00 per cent of carbon, called *cast iron*, which is much weaker and much less ductile than classes (1) and (2). Cast iron may be either "white," "gray" or "mottled."

In *white cast iron* most of the carbon is chemically combined with the iron instead of being in the state of graphite.

Gray cast iron contains much of its carbon in the condition of graphite, so that the cast iron itself is a conglomerate of this free or graphitic carbon mechanically mixed with the remainder or metallic part of the mass, which may be called the "matrix."

Mottled cast iron is intermediate in composition between gray and white cast iron, having part of its carbon free or graphitic, and the rest chemically combined with the iron.

Of these three kinds of cast iron, the gray is by far the softest and least brittle, the white is the hardest and most brittle, while the strongest cast iron is between the extremes of the grayest and the whitest.

Gray cast iron may be as soft as the low-carbon steels, and white cast iron may be as hard and perhaps harder than any even of the high-carbon steels; but all these cast irons are both weaker and more brittle than either low or high-carbon steel. Thus all cast irons are weak and brittle, but some are very soft and others very hard.

Fig. 59, p. 162, shows in a general way these three important physical properties, the strength, ductility, and hardness of these three classes of iron (for the moment leaving gray and mottled cast iron out of sight), and how these properties are related to the carbon-content. The whole may be summed up by saying that as the carbon increases, the hardness increases and the ductility decreases, both without limit; but that the tensile strength reaches a maximum with about 1.00 or 1.20 per cent of carbon, and decreases with farther increase of carbon.

Wrought Iron. — The members of the weld-metal class contain a small quantity (usually from 0.20 to 2.00 per cent) of slag or cinder, (in this case a very basic silicate of iron oxide), because they are made by welding together pasty particles of metal at a very high temperature, in a bath of this slag, without subsequent fusion or other means of expelling it completely. Of this series the only member today of importance is wrought iron, which usually contains only a very little carbon. Its characteristic structure is shown in Fig. 61, in which the black streaks are little rods of slag drawn out in the process of rolling or hammering the balls, in which the wrought iron is first made, into bars or sheets. The remainder of the mass is essentially made up of separate crystals of nearly pure iron or "ferrite," interfering with each other and hence misshapen. The differences in tint are due

to differences in the way in which different crystals are acted upon by the nitric acid or other reagent with which the specimen is etched, differences which in turn are due to such causes as difference in orientation, *i. e.*, in the direction of the axes and cleavage of the different crystals.

Wrought iron differs from the low-carbon steels, *e. g.*, from those used for making rivets, fencing-wire, and the sheet iron used for conversion into tin plate by coating with tin, essentially in containing this small quantity of slag. Such steel is practically

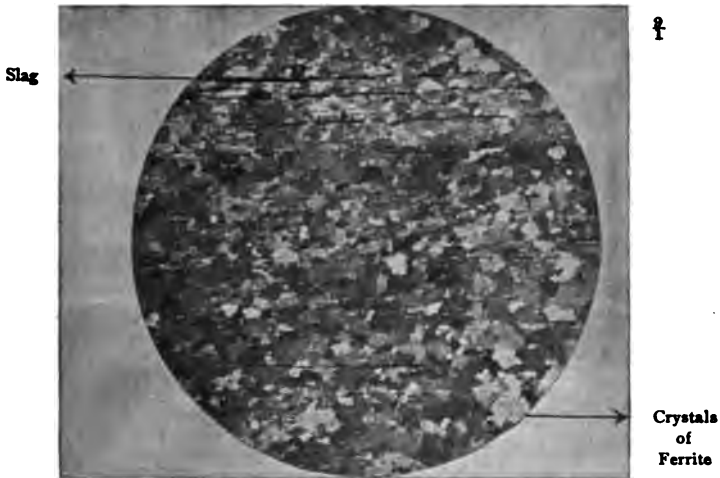

Fig. 61. Wrought Iron Forged. Longitudinal Section.

With the exception of the rods of slag shown in black, the whole of the mass consists of crystals of ferrite interfering with each other and therefore irregular in shape. (Sorby, *Jour. Iron and Steel Inst.*, I, 1887, p. 255, *et seq.*)

free from slag, for the simple reason that it is cast in a very fluid state into ingots or other castings, and that this fluidity enables any slag present to separate by rising to the surface by gravity. The carbon-content of wrought iron and of such steel is substantially the same, and hence their properties are closely alike, save in so far as those of wrought iron are affected by the presence of this small quantity of slag. As such steel is actually made, it usually contains rather more manganese but less phosphorus than most wrought iron; this gives a slight further difference in

properties between most wrought iron and most of such steel; but this difference is neither necessary nor essential.

142. DEFINITIONS. — In considering the foregoing classification we note that there are two distinct bases for the name steel. The "weld-steels" are called steel because they differ from wrought iron in containing a considerable quantity of carbon, and from cast iron in being malleable; the low-carbon steels are called steel because they differ from wrought iron in being slagless, and from cast iron in being malleable. This confusing nomenclature must be endured, at least for the present.

But the matter is not so serious as it looks at first. The weld steels are unimportant. The three important classes are wrought iron, steel, and cast iron. Wrought iron is readily and almost sharply distinguished from the others by its containing slag. And, fortunately, there is one criterion which we may adopt for discriminating between all the various classes of steel on one hand and those of cast iron on the other, a criterion which we may apply to all future varieties of iron when we seek to decide whether they ought to be called steel or cast iron. This criterion is malleableness in at least some one range of temperature; we may adopt it because such malleableness is probably the only important specific property which all steels of to-day have, and all cast irons of to-day lack, if we except the special product known as "malleable cast iron," which really stands in a class by itself, through its genesis, constitution and properties. In the following scheme of definitions this criterion is used.

Cast iron, iron containing so much carbon or its equivalent as not to be malleable at any temperature.

In case of the normal or carbon cast irons, which owe their properties chiefly to their carbon-content, as distinguished from the alloy cast irons (see below), the dividing line between steel and cast iron may for the present be put arbitrarily at 2.00 per cent of carbon. As soon as the boundary between the normally graphitiferous and the normally non-graphitiferous varieties of the iron-carbon compounds shall have been determined, it may be well to adopt this natural division line as the boundary between steel and cast iron, instead of the arbitrary boundary which is here used as a temporary expedient. (See § 163, p. 195.)

In gray cast iron a considerable part of the carbon is present as free graphite; in white cast iron there is very little graphite,

most of the carbon being in chemical combination with the iron. In mottled cast iron an intermediate quantity of graphite is present.

Malleable cast iron, iron which when first made is cast in the condition of cast iron, and is made malleable by subsequent treatment without fusion.

Steel, iron which is malleable at least in some one range of temperature, and also is either (a) cast into an initially malleable mass; or (b) is capable of hardening by sudden cooling; or (c) is both so cast and so capable of hardening. (Tungsten steel and certain classes of manganese steel are malleable only when red-hot.)

Alloy steels and *cast irons* are those which owe their properties chiefly to the presence of an element (or elements) other than carbon.

Wrought iron, slag-bearing, malleable iron, which does not harden materially when suddenly cooled. Most wrought iron today is "puddled iron," *i. e.*, made by the puddling process (§ 274, p. 344).

Ingot iron, (rare), slagless steel containing less than 0.30 per cent of carbon.

Ingot steel, (rare), slagless steel containing more than 0.30 per cent of carbon.

Weld iron, (rare), the same as wrought iron.

Weld steel, (rare), slag-bearing varieties of iron malleable at some temperature, and containing more than 0.30 per cent of carbon. It differs from wrought iron only in containing more carbon.

Some additional definitions are given in Appendix 2.

143. CARBON AND IRON.—In our study of the metallography of iron, which occupies the rest of this chapter, we may confine our attention to the slagless or ingot-metal series, and to the normal or carbon group of that series, leaving both the weld-metal series and the alloy steels and alloy cast irons out of consideration. What we are going to consider, then, is a series of quasi-alloys of iron and carbon, called *steel* when they contain less than say 2 per cent of carbon, and *cast iron* when they contain more.

Let me again emphasize the fact that the properties of the metal are profoundly influenced by its carbon-content. The essential difference between the most ductile rivet steel, nearly as

soft and malleable as copper, and the hardest or most springy tool or spring steel, and the hardest and most brittle cast iron, is due to the differences in the quantity and condition of their carbon. Table 5 illustrates this.

TABLE 5.

PERCENTAGE COMPOSITION OF TYPICAL KINDS OF STEEL						STATE IN WHICH USED	
NAME	C	Si	Mn	P	S		
Rolled or Forged Steel	Rivets04 to .10	.05	.65	.04	.06	Slowly cooled or Pearlite series
	Tubes06 to .08	.01	.60	.12	.06	
	Tires6 to .7	.25	.79	.05	.05	
	Bridge08 to .18	.10	.80	.06	.07	
	R. R. Axles	.25 to .40	.04 to .06	.40 to .80	.06	.05	
	Amer. Rails	.45 to .70	.10 to .20	.80 to 1.10	.06 to .10	.06 to .10	
Steel Castings	Dynamos . .	.15	.12	.04	—	—	Slowly cooled or Pearlite series
	Electrical. }	.25	.20	.45	.08	.05	
	Harder Castings	.10	.25	.10			
		.30 to .50	.35 to .50	.80	.05	.05	
Rolled or Forged Steel	R. R. Car Springs Cutting Tools	.75	.35	.85	.07	—	Suddenly cooled or Austenite series
	Files75 to 1.50	—	—	—	—	
		1. to 1.50	—	—	—	—	
			—	—	—	—	

It is most simple to assume that, in molten iron, all carbon is simply dissolved, and all is alike, no matter what may be the condition of that carbon when the metal solidifies; in short, that all molten carbon-iron compounds are similar solutions of carbon in iron or *vice versa*, differing from each other only in the degree of concentration of this solution.

When, however, the iron solidifies, the carbon may either pass into the condition of free carbon, that is to say, graphite; or it may remain dissolved in the now solid iron, as a solid solution to which the name "austenite" is given. When the metal further cools this austenite and graphite may be preserved and found as such in the cold metal, or they may undergo, partly or wholly, a transformation which leaves the carbon as a definite iron carbide, Fe_3C , called *cementite*.



There are thus three distinct conditions in which carbon can exist in solid iron, (1) as free graphite, characteristic of gray cast iron; (2) as a solid solution of carbon in iron, *austenite*, the characteristic of "hardened," *i. e.*, suddenly cooled steel, and chilled cast iron; and (3) as cementite, an iron carbide Fe_3C , characteristic of normal or slowly cooled steel and cast iron. These and the other constituents of iron will be described in § 145, and at the same time the regions in Fig. 68 (p. 194), in which these constituents ought theoretically to be present, will be enumerated. This figure has already been alluded to in the latter part of § 139, p. 165, and it will be described at much greater length in § 162, p. 193.

144. SOURCE OF THE CONFUSION IN OUR NOMENCLATURE. —

It may be of interest to expose in passing the way in which much of the confusion in our present nomenclature has arisen, both to show the student from what motives these systems may arise, and also to give warning of the sort of trouble which is likely to arise in case we give names based, not on essential and definitive properties, but on accidental ones which are not definitive, no matter how important they may be.

Until about 1860 there were only three important classes of iron, — wrought iron, steel and cast iron. The essential characteristic of wrought iron was its nearly complete freedom from carbon; that of steel its moderate carbon-content (say between 0.30 and 2 per cent), which, though great enough to confer the property of being rendered very hard by sudden cooling, yet was not so great as to make the metal brittle when cooled slowly; while that of cast iron was a carbon-content so high as to make the metal brittle whether cooled quickly or slowly. This classification was based on carbon-content, or on the properties which it gave. Wrought iron, and certain classes of steel which then were important, necessarily contained much slag or "cinder," because they were made by welding together pasty particles of metal in a bath of slag, without subsequent fusion. But the best class of steel, crucible steel, was freed from slag by fusion in crucibles; hence its name, "cast steel."

Between 1860 and 1870 the Bessemer and open-hearth processes introduced a new class of iron, to-day called "mild" or "low-carbon steel," which lacked the essential property of steel, the hardening power, yet differed from the existing forms of

wrought iron in its freedom from slag, and from cast iron in being very malleable. Logically it was wrought iron, the essence of which was, that it was (1) "iron" as distinguished from steel, and (2) malleable, *i. e.*, capable of being "wrought." This name did not please those interested in the new product, because existing wrought iron was a low-priced material. The only justifiable alternative would have been to assign a wholly new name to the wholly new product; but as steel was associated in the public mind with superiority, it appeared more attractive to appropriate its valuable name. This was done with the excuse that the new product resembled one class of steel — cast steel — in being free from slag; and, after a period of protest, all acquiesced in calling the new product "steel," which is now its firmly established name. The old varieties of wrought iron, steel, cast steel, and cast iron preserve their old names; the new class is called steel by main force. As a result, certain varieties, such as blister steel, are called "steel" solely because they have the hardening power, and others, such as low-carbon steel, solely because they are free from slag. But the former lack the essential quality — slaglessness — which makes the latter steel, and the latter lack the essential quality — the hardening power — which makes the former steel. "Steel" has come gradually to stand rather for excellence than for any specific quality.

These anomalies, however confusing to the general reader, in fact cause no appreciable trouble to important makers or users of iron and steel, beyond forming an occasional side-issue in litigation.

145. THE MICROSCOPIC CONSTITUENTS OF IRON AND STEEL. — The general features of the constitution of alloys outlined in Chapter I, may be here recapitulated with the aim of applying them specially to iron and steel.

The great advance which has taken place in our knowledge of the constitution of steel and the other varieties of iron has shown that they resemble very closely the igneous and metamorphic rocks, *i. e.*, exactly those which, like the different varieties of iron, have formed from the cooling of molten or at least pasty masses. Just as a granite on close examination is seen to consist of an aggregation of crystalline fragments of mica, quartz, and feldspar, each of which is a definite chemical compound, with definite crystalline form and definite physical properties in general, so the microscope

shows us that a given piece of steel or iron usually consists of extremely minute crystalline particles of two or more substances, each of which is a definite entity, with definite chemical composition and definite physical properties.

But besides the granitic type, certain varieties of iron seem to represent the obsidian type. In this, as in aqueous solutions, the ratios in which the different chemical substances, the silica, lime, *etc.*, exist are not fixed or definite; they vary from case to case, not *per saltum*, as between definite chemical compounds, but by infinitesimal gradations. The different substances present appear to be dissolved, as it were, in each other in a sort of solid solution which has the indefiniteness of composition, the incapacity of being resolved by any magnification of the microscope, and the feeble chemical attraction between the different components, characteristic of a solution.

The schistose structure of rock masses, their columnar or basaltic structure arranged in columns perpendicular to the cooling surface, their "vugs" or cavities lined with specimens of free crystals, their segregation, *etc.*, are reproduced in a most interesting way in metallic masses.

Of these different microscopic entities which constitute the different varieties of iron, only the following here need consideration:

(1) FERRITE, the microscopic particles of nearly and perhaps perfectly pure metallic iron. It is magnetic, very soft and ductile, but relatively weak, with a tensile strength of about 45,000 pounds per square inch. It is of the isometric system. It always forms a very important part of slowly cooled iron and steel in general (excepting the alloy classes).

It is a normal constituent of regions V, VI and IX of Fig. 68.

When much slag is present, as in wrought iron, and is drawn out into fibers by rolling, the mass as a whole is thereby given a certain kind of pseudo-fibrousness; but even here the metallic or ferrite quasi-fibers usually consist of an aggregation of grains, each of which is equiaxed. (See Fig. 61.)

146. (2) CEMENTITE, a definite carbide of iron, Fe_3C , containing 6.67 per cent of carbon, very brittle, harder than hardened steel, scratching glass and feldspar but not quartz, ($H = 6$), and magnetic. The carbon in slowly cooled steel is chiefly or wholly present as cementite, of which there is therefore $(56 \times 3 + 12) \div$

12 = 15 per cent for each per cent of carbon present. In slowly cooled as distinguished from "chilled" cast iron, too, it is probable that all or nearly all of the combined carbon as distinguished from the graphite is present as cementite. It is one of the constituents of pearlite, and is an important constituent of slowly cooled iron and steel in general, of course excepting the varieties which are nearly free from carbon. Its carbon is often spoken of as *cement-carbon*, and is the *carbide-carbon* of Ledebur.

It is a normal constituent of regions VI, VIII and IX of Fig. 68.

147. (3) PEARLITE, a eutectoid or quasi-eutectic (§ 148), consisting of interstratified plates of ferrite and cementite, in the ratio of about six parts by weight of the former to one of the latter, as inferred from its containing about 0.90 per cent of carbon. The exact composition of pearlite is still in dispute, and I adopt this number of 0.90 per cent only provisionally and for the purpose of fixing our ideas.

Slowly cooled steel consists essentially of a conglomerate of this pearlite plus the excess-substance (see § 34, p. 39), which is ferrite if the carbon-content is below 0.90 per cent, but is cementite if it is above 0.90 per cent. Paraphrasing Osmond, steel may be called "eutectoid," "hyper-eutectoid" or "hypo-eutectoid," according to whether it contains just 0.90 per cent of carbon, or more than that or less. (See Fig. 65, p. 185.)

Slowly cooled cast iron probably consists essentially of a conglomerate (1) of pearlite with its accompanying excess of either ferrite or cementite according to whether the combined carbon is less or greater than 0.90 per cent, and (2) of graphite.

Pearlite is formed by the spontaneous decomposition of austenite, *e. g.*, in cooling past the transformation-point, A_{r1} , PSP' , Fig. 68.

It is a normal constituent of regions VI and IX of Fig. 68.

Fig. 62 shows the structure of pearlite. The black stripes are the ferrite, which, although itself white, here looks black simply because it is so much softer than the cementite that in polishing it is ploughed into deep furrows, which, because they are in the shadow of their own walls, look black.

148. EUTECTOID. — Pearlite is a "eutectoid" or quasi-eutectic; in other words, the solid-solution alloy of the lowest transformation-point. The eutectoid is to these transformations within

the solid solution, the solid metal, exactly what the eutectic is to the freezing of a molten solution, a molten eutectiferous alloy. These transformations may be selective, exactly as the freezing is selective, and as they progress the solid mother-metal, in this case austenite, progressively approaches the eutectoid or pearlite ratio of about 0.9 per cent of carbon, exactly as the mother-metal of a freezing alloy progressively approaches the eutectic composition.

As with a eutectic so with a eutectoid, its most striking properties are:

(1) that for any given solid solution its composition and hence its transformation temperature are constant, no matter what

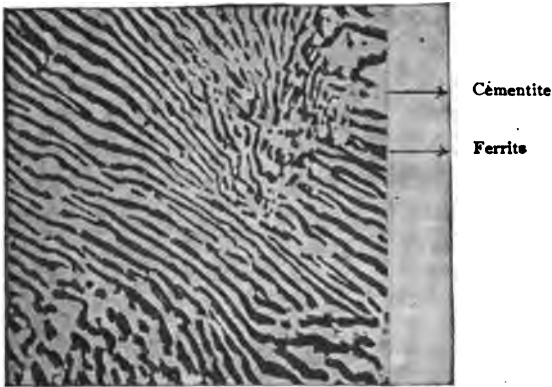

Fig. 62. Pearlite. Steel (carbon about 1 per cent) forged and annealed at 800° C. (F. Osmond, *Baumaterialienkunde*, II, p. 53, *et seq.*, Fig. 17.)

the initial ratio of the constituent substances is (in the present case the ratio of iron to carbon),

(2) that its composition is not, save occasionally and as it were by accident, in simple atomic proportions (see footnote to § 149), and

(3) that it consists of a conglomerate of distinct particles mechanically mixed.

149. (4) AUSTENITE, and the transition forms MARTENSITE, TROOSTITE, and SORBITE, may here be considered together.

AUSTENITE,* a solid solution of carbon (or perhaps of an

* "L'austénite, au contraire, que l'on a des raisons de considérer

iron carbide), in gamma allotropic iron, is hard and brittle when cold, is normal and hence stable at temperatures above the critical temperature A_s , *i. e.*, in regions II, IV and VII of Fig. 68, and is slowly transformed by reaction (9), p. 203, into pearlite with either ferrite or cementite as an excess substance, in cooling across region V or VIII into region VI or IX, in which, as already pointed out, ferrite and cementite are the normal and hence stable forms. When it is of the eutectoid composition, *i. e.*, that of pearlite, 0.90 per cent of carbon, it is sometimes called "hardenite."

Because the transformation takes an appreciable time, and because it is indeed arrested on reaching the common atmospheric temperature, it results that if steel in region IV or VII is cooled very quickly as in the "hardening" process of quenching in water, the transformation has not time to complete itself, and the cold steel, instead of consisting wholly of ferrite and cementite, is by lag preserved in one or more of the successive transition stages of, first, martensite, next, troostite, and third, sorbité. Indeed, part of the austenite itself may be preserved without changing even as far as martensite, for instance when steel containing 1.10 per cent or more of carbon is quenched from above A_s (SE, Fig. 68), in a freezing mixture.* Here and elsewhere carbon seems to retard the change from austenite towards ferrite and cementite; and manganese and nickel have a like effect, so that even without sudden cooling a very large proportion of gamma iron, the characteristic component of austenite, is probably present in certain manganese and nickel steels when cold, giving them very valuable properties.

The difference between these three transition substances and the difference between them and the three primary substances, austenite, ferrite, and cementite, may be only mechanical and quan-

comme non-magnétique, peut représenter les cristaux mixtes gamma in-tacts." Osmond, "Méthode Générale," *Contribution à l'Étude des Alliages*, p. 325, 1901. He restricts the meaning of austenite to the substance present in the cold steel, speculating that it may be identical with the solid solution in gamma iron which exists in regions IV and VII. In breaking away from his definition and defining austenite as the solid solution which exists in these regions, and assuming provisionally that the substance called austenite, which exists in suddenly cooled high-carbon steel actually is identical with it, I hope to simplify the subject so that a larger class of readers may understand it.

* *Idem*, p. 295.

titative, or it may in addition be essential. It may be only mechanical and quantitative, so that these three substances may be simply mechanical mixtures of the three primary substances, differing first mechanically in the size and mode of admixture of the particles of these primary substances, and second quantitatively in the proportion in which these primary substances are present, just as orange, green, indigo and violet really differ only in containing the three primary colors, red, yellow, and blue, in different proportions. Or, in addition to these mechanical and quantitative differences, which are certainly very important, there may be essential differences, *i. e.*, one or more of the transition substances may necessarily and essentially either contain some other primary substance or lack some one of the three known primary substances. Although there is much evidence to support this latter theory, so that many, myself included, believe that martensite, for instance, and the hardened steel of which it is characteristic, owe their properties in part to the presence of beta allotropic iron, yet the evidence is so far from conclusive, opinions differ so much, and the mechanical theory is so much easier to teach and to work with, and it groups together so well the facts important to the practitioner, that it is here adopted provisionally. (See § 342.)

MARTENSITE, the characteristic condition of hardened steel and probably of chilled cast iron, on this theory represents the arrest of the transformation at an early stage, when enough ferrite and cementite have formed within the austenite to modify greatly the properties of the whole, and therefore it is not a definite stage, but it covers a considerable fraction of the course of transformation, though there are convenient boundaries between it and austenite on one hand and troostite on the other, quite as changes in slope form convenient arbitrary boundaries of a mountain, even though it actually shades off without real break into the adjoining plains. In hyper-eutectoid steel it should be chiefly cementite, in hypo-eutectoid steel chiefly ferrite, which has replaced the initial austenite. Its typical structure, apparently that of the austenite from which it forms,* is that shown in Fig. 64, with well marked needles forming three sides of a triangle,

* By etching steel of 1 per cent of carbon when in region IV, where austenite is the natural constituent, Saniter developed a structure much like that of Fig. 64. *Jour. Iron and Steel Inst.*, 1898, I, p. 209.

and often crossing each other, unlike the layers in pearlite which never cross each other. Though the hardness of both austenite and martensite varies very greatly, not only from specimen to specimen, but even in the same specimen,* when austenite and martensite occur together, the martensite is decidedly the harder of the two.† In general it is the harder the more carbon the steel contains, and the more suddenly it is cooled from above the critical range.

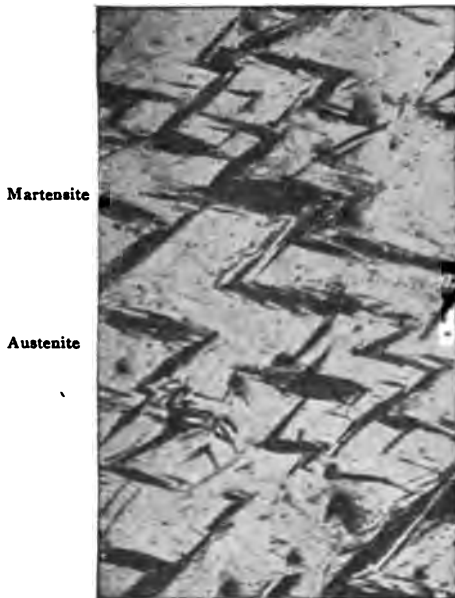

Fig. 63. Martensite (black) in Austenite (white). Steel of about 1.50 per cent Carbon. Quenched at $1,050^{\circ}$ C. in ice water. (Osmond, *The Metallographist*, II, p. 261, *et seq.*)



Fig. 64. Martensite. (Osmond and Cartaud, *Annales des Mines*, XIV, p. 62, 1900; *The Metallographist*, IV, p. 236, *et seq.*)

TROOSTITE,‡ the next stage, should contain less austenite, but more ferrite or cementite or both, than martensite. Tempered steel, *i. e.*, steel which has first been brought to the martensite stage by sudden cooling, and has then had its extreme brittleness “tempered” or mitigated by reheating it until its surface

* Kourbatoff, *Revue de Métallurgie*, III, p. 177, 1905.

† Osmond and Stead, *Microscopic Analysis of Metals*, 1904, pp. 170-172.

‡ It has been held, but without just warrant, to be ferrite. Boynton, *Jour. Iron and Steel Inst.*, 1904, I, p. 262.

is coated with a thin skin of iron oxide, probably represents this troostite stage.

SORBITE, the last stage before the completion of the transformation, probably consists chiefly of pearlite with its excess of either ferrite or cementite, perhaps still retaining some residual austenite. But its constituents cannot be detected by the microscope, probably because although the transformation has nearly completed itself, the particles of ferrite and cementite which it has created have not yet succeeded in coalescing into masses large enough to be distinguished.

It is reasonably thought that the excellent quality which can be given by specially managed cooling is due to the very fine division which is the essence of sorbite. Naturally, sorbite shades off without break into troostite on one hand, and through the stage of sorbitic or badly resolved pearlite into that of true pearlite with its excess of ferrite or cementite on the other hand.

The magnetic properties and their relations to these transition stages are briefly discussed in § 336, Appendix 3.

150. (5) GRAPHITE, a characteristic component of "gray cast iron," of which it usually forms from 2.00 to 3.50 per cent. It is pure or nearly pure carbon. When it forms during the solidification of the metal, as is usually the case, it occurs in very thin laminated plates or flakes, often $\frac{1}{8}$ inch or more in diameter, and curved as shown in Fig. 60, p. 164. When it forms within the solid metal at temperatures materially below the freezing-point, it occurs, at least under certain conditions, in very fine powder, and is then called "temper" graphite, the temper-carbon of Ledebur.

It is a normal constituent of regions III and VII of Fig. 68. When graphite-bearing iron cools out of region VII into regions VIII and IX, all the graphite theoretically should be transformed into cementite by reaction (10) $\text{Gr} + 3\text{Fe} = \text{Fe}_3\text{C}$. (See § 172, p. 200.) But owing to the lagging of this reaction, graphite usually persists and is actually found in the metal in regions VIII and IX.

151. (6) SLAG, the characteristic component of wrought iron, which usually contains from 0.20 to 2.00 per cent of it. It is essentially a ferrous silicate, and is present in wrought iron simply because this variety of iron is made by welding together pasty granules of iron in a bath of such slag, without subsequently melting

the resultant mass or in any other way giving the envelopes of slag thus imprisoned a chance to escape completely.

152. (7) THE EUTECTIC formed in the slow freezing of cast iron, *i. e.*, of any iron containing over say 2 per cent of carbon. It contains about 4.30 per cent of carbon, and is a conglomerate of (1) austenite, saturated and hence containing about 2 per cent of carbon, and (2) graphite; so that the eutectic contains about 1.95 per cent of combined or dissolved carbon present in the 97.6 per cent of austenite, and 2.34 per cent of graphite. It is a normal constituent of slowly cooled, *e. g.*, gray cast iron, which may be called hyper- or hypo-eutectic according to whether it contains more or less than 4.30 per cent of carbon, *i. e.*, according to whether graphite or austenite is present in excess over the eutectic ratio.

153. CALCULATION OF THE CONSTITUTION OR PROXIMATE COMPOSITION OF SLOWLY COOLED STEEL AND OTHER STOICHIOMETRIC CALCULATIONS. — We have already seen (§ 148, p. 178) that slowly cooled steel consists essentially of a conglomerate of pearlite together with either ferrite or cementite as the excess-substance, according to whether the percentage of carbon combined with the metallic iron is below (hypo-eutectoid) or above (hyper-eutectoid) the eutectoid ratio of about 0.90 per cent. In the former case the excess-substance is iron or ferrite, in the latter it is carbon or cementite, according to our point of view.

To avoid confusion let us here distinctly recognize that in any hyper-eutectoid steel, for instance one containing 1.00 per cent of carbon, cementite is the excess and iron the deficit-substance, in that there is more carbon but less iron present than corresponds to the eutectoid or pearlite ratio of carbon 0.90, iron 99.10 per cent; and this is perfectly true in spite of the fact that the percentage of iron by weight is ninety-nine times that of the carbon.

As pearlite itself is a conglomerate of ferrite with cementite, so slowly cooled steel whether eutectoid, hypo-eutectoid or hyper-eutectoid, is composed in reality of ferrite and cementite, of which a part is interstratified in the 6:1 ratio as pearlite, and the rest, ferrite or cementite as the case may be, is present as the excess-substance. Such excess is often spoken of as "structurally free" ferrite or cementite.

How much cementite is implied by the presence of 1 per cent of carbon? The presence of 1 per cent of carbon in the mass in the condition of cementite, Fe_3C , implies the presence of

$\frac{3 \times 56 + 12}{12} = 15$ per cent of cementite and of $\frac{3 \times 56}{12} = 14$ per cent of iron in that cementite. Here 12 and 56 are the atomic weights of carbon and iron respectively. Conversely, the presence of 1 per cent of cementite implies the presence of $\frac{1 \times 12}{56 \times 3 + 12} = 0.0667$ per cent of carbon.

How much carbon does cementite contain? The formula of this substance, Fe_3C , shows that it contains $12 \times 100 \div (56 \times 3 + 12) = 6.67$ per cent of carbon.

What is the percentage of ferrite and cementite in pearlite? As pearlite contains about 0.90 per cent of carbon, and as the carbon is present in this pearlite in the form of cementite, so pearlite contains about $0.90 \times 15 = 13.5$ per cent of cementite; and by difference it must contain about $100 - 13.5 = 86.5$ per cent of ferrite, or $86.5 \div 13.5 = 6.4$ parts by weight of ferrite for each part of cementite. To avoid an unjustified air of accuracy, this ratio is called 6:1 in this work.

How much pearlite and how much excess ferrite correspond to a given percentage of carbon in a hypo-eutectoid steel? To fix our ideas let us consider the case of steel containing 0.50 per cent of carbon. We have just seen that this implies the presence of $0.50 \times 15 = 7.50$ per cent of cementite. With this cementite will be associated $7.50 \times 6.4 = 48.0$ per cent of ferrite in the form of pearlite; so that the total quantity of pearlite will be $7.50 + 48.0 = 55.5$ per cent or say 56 per cent.

The remainder of the steel will then be $100 - 55.5 = 44.5$ or say 44 per cent of free ferrite, over and above that contained in the pearlite or in short of "excess ferrite." To sum this up the constitution will be:

Cementite, $0.50 \times 15 =$	7.50
Ferrite associated with it as pearlite, $7.50 \times 6.4 =$	48.00
Total pearlite	55.50
Excess, or free, or "structurally free" ferrite by difference	44.50
	100.00

In like manner Table 6 and the lines in Fig. 65 have been calculated. In each of these the same principle has been extended so as to cover the graphiteless white cast irons, which really form a prolongation of the hyper-eutectoid steels.

TABLE 6. — *Theoretical Constitution or Microstructural Composition of the Pearlite Series, Slowly Cooled Steel and White Cast Iron, on Sauveur's Plan.*

NAME		CARBON PER CENT	PROXIMATE COMPOSITION PER CENT				
			Pearlite	Excess* Ferrite	Excess* Cementite	Total Ferrite	Total Cementite
Steel	Low-carbon	0	0	100	0	100	0
		0.10	11	89	0	98.5	1.5
		0.20	22	78	0	97.0	3.0
	Medium-carbon	0.30	33	67	0	95.5	4.5
		0.40	44	56	0	94.0	6.0
		0.50	56	44	0	92.5	7.5
		0.60	67	33	0	91.0	9.0
		0.70	78	22	0	89.5	10.5
	High-carbon	0.80	89	11	0	88.0	12.0
		0.90	100	0	0	86.5	13.5
		1.00	98	0	2	85.0	15.0
		1.10	97	0	3	83.5	16.5
		1.20	95	0	5	82.0	18.0
		1.30	93	0	7	80.5	19.5
		1.40	91	0	9	79.0	21.0
		1.50	90	0	10	77.5	22.5
		1.60	88	0	12	76.0	24.0
		1.70	86	0	14	74.5	25.5
		1.80	84	0	16	73.0	27.0
1.90	83	0	17	71.5	28.5		
White Cast Iron	2.00	81	0	19	70.0	30.0	
	2.10	79	0	21	68.5	31.5	
	2.20	77	0	23	67.0	33.0	
	2.30	76	0	24	65.5	34.5	
	2.40	74	0	26	64.0	36.0	
	2.50	72	0	28	62.5	37.5	
	2.75	68	0	32	58.75	41.25	
	3.00	64	0	36	55.0	45.0	
	3.25	59	0	41	51.25	48.75	
	3.50	55	0	45	47.5	52.5	
	3.75	51	0	49	43.75	56.25	
4.00	46	0	54	40.0	60.0		
4.50	38	0	62	32.5	67.5		

* "Excess Ferrite" means the ferrite in excess over the pearlite ratio, or in other words, the free or structurally free ferrite which does not form part of the pearlite. "Total Ferrite" means the sum of this excess ferrite plus that contained in the pearlite. So, *mutatis mutandis*, with "Excess Cementite" and "Total Cementite."

TABLE 7.—Classification of Iron and Steel by Carbon-c

TOTAL CARBON PER CENT	UNHARDENED STEEL AND WHITE CAST IRON OR PEARLITE SERIES								GRA		
	Name	Prominent Uses	Percentage of Carbon		Microscopic Constitution Per Cent				Name	Promi Us	
			As Cementite	Graphite	Ferrite	Cementite	Graphite	Slag			
0.05 to 0.3	Wrought Iron		0.05 to 0.3		99.0 to 93.6	0.75 to 4.5		0.2 to 2.0	} Lat		
	Low-carbon or Mild Steel	Boilers, Ship and Structural Steel	0.05 to 0.3		99.25 to 95.5	0.75 to 4.5					
0.3 to 0.8	Medium-carbon Steel	Axles, Shafting, Tires, Rails	0.3 to 0.8		95.5 to 88.0	4.5 to 12.0	little or none				
0.8 to 2.00	High-carbon Steel unhardened	Little used	0.8 to 2.00		88.0 to 70.0	12.0 to 30.0	usually little or none				
2.0† to 4.5	White Cast Iron, and Chilled Cast Iron after annealing	Treads of Cast Iron railroad wheels, and other "chilled" castings	1.0 to 4.5	0 to 1.0	84.0 to 32.5	15.0 to 67.5	0.0 to 1.0		Gray and Mottled Cast Iron	Gray casting gener (Mott Cast has direct	

* This table is intended to give only a bird's-eye view or very rough classification. series. Mottled cast iron has few direct uses, except, of course, that it, like gray cast i

† For simplicity the limits of total carbon for cast iron are taken as 2.0 and 4.5 pe commercial white cast iron, and the remainder of the carbon is assumed to be present as carbon; but the remaining classes (steel of from 1.5 to 2.0 per cent and cast iron of from

‡ While springs, cutting tools, and like objects may for convenience be regarded in tempering them, the austenite becomes much decomposed, passing towards the condit decomposition.

Microscopic Constitution, Showing the usual Limits.*

IRON OR FE SERIES				TYPICAL HARDENED STEEL OR AUSTENITE SERIES				
Carbon in Per Cent	Microscopic Con- stitution Per Cent			Name	Prominent Uses	Carbon in State of		Microscopic Constitution
	Graphite	Ferrite	Cementite			Cementite	Austenite	
Important				Low-carbon Steel Hardened	Little used			Low-carbon Austenite Chiefly †
				Medium- carbon Steel hardened (and tempered)	Some springs	0.3 to 0.8 chiefly as Austenite		Medium-carbon Austenite, Chiefly †
				High-carbon Steel hardened (and tempered)	Cutting tools, springs	0.8 to 2.0 chiefly as Austenite		High-carbon Austenite, Chiefly †
	1.0 to 4.0	98.0 to 47.0	0.0 to 52.0	1.0 to 4.0	Chilled Cast Iron unannealed		2.0 to 4.5 chiefly as Austenite	

Actual limits in particular are very rough. This is particularly true of the third or austenite conversion into wrought iron and steel.

Percentage of graphite is taken as from 1.0 to 4.0 for gray cast iron and from 0 to 1.0 for steels contain more than 1.5 per cent carbon, and few cast irons less than 3 per cent carbon) are here included so as to embrace the whole field of the iron-carbon compounds. In referring to this series, it is to be understood that in hardening them, and more particularly in the case of steel and cementite. We have as yet little direct information as to the degree of this

154. SUMMARY. — To recapitulate, the chief constituents of the iron-carbon compounds, the steels and cast irons, are:

(1) in the slowly cooled state of both steel and cast iron, *pearlite*, a conglomerate of (2) the soft, weak, ductile *ferrite*, and (3) the hard brittle *cementite*, in the ratio of 6:1, together with whatever excess of ferrite or cementite is present over and above this ratio, (4) also in the slowly cooled state of cast iron, *graphite*, a non-metallic and as it were foreign body, (5) in the suddenly cooled state of both steel and cast iron, *austenite*.

We may classify all our iron-carbon compounds, all our steels and cast irons, according to this grouping.

155. DIVISION OF IRON INTO THREE SERIES ACCORDING TO MICROSCOPIC CONSTITUTION. — In the slowly cooled state the metal will be either (1) pearlite with ferrite or cementite as the excess-substance, in which case we can call the whole series from carbon zero to carbon 4.50 per cent the *pearlite series*; or (2) pearlite plus ferrite or cementite as the excess-substance as before, but in addition graphite, in which case we can call the whole series the *graphito-pearlite series*. In general, but little graphite is present unless there is at least 2 per cent of total carbon, *i. e.*, it is only in cast iron that any important quantity of graphite is usually found. The graphito-pearlite series may then be called also the gray-cast-iron series.

In like manner we may call the suddenly cooled series, from carbon zero to carbon say 4.50 per cent, the *austenite series*.

In each series the metal is called "steel" if it contains less than two per cent of carbon, and "cast iron" if it contains more.

The theoretical constitution, the trade names, and the chief uses of the members of these three series are recapitulated in Table 7. These series are to be regarded as types to which any given piece of iron approaches more or less closely. Thus, while slowly cooled low-carbon and medium-carbon steel is usually exactly of the pearlite-series type, except in so far as its constitution is disturbed by the presence of manganese and other elements, yet slowly cooled high-carbon steel may vary slightly from the type by containing a small quantity of graphite. In particular it is doubtful whether any piece of metal is ever exactly of the austenite type, because no matter how sudden the cooling some of the austenite changes into or at least towards the ferrite and cementite condition, and because some of the carbon may, even after sudden cool-



here, ATP
th
im

in J
omp
or
of t
elo
nt.
ite.
e, i
0,50
erri
ed th
sell c
errit
te n
ands

is 1

AST:20
ld th
ork, s
s to

of th
deed
st sig
g coar
tite.
of /
dark
a dis
round
masse
more
which
are th
Fur

ustenit
to pear
ra mass
Stable
the da
he pro

NOTE TO FIG. 66.

purpose of this illustration is to show how the micro-
the pearlite series, taken from end to end, corresponds
imate constitution of that series as set forth in Table 6

in particular, how, starting with pearlite alone with the
composition, 0.90 per cent carbon, as the carbon-content
or falls below this eutectoid proportion, an increasing
of the excess-substance appears, ferrite as the carbon
below 0.90 per cent, cementite as it increases beyond
ent. The pearlite is dark, the excess ferrite and cemen-
ite, except in *E*, in which the pearlite occupies the
e, its cementite being white and its ferrite black.

0.50 per cent of carbon, there is a well-marked network
ferrite enclosing meshes consisting chiefly of pearlite,
ed through considerably with fine needles of excess fer-
well oriented. With 0.45 per cent of carbon the network
ferrite is thicker. With 0.22 per cent of carbon the
ite now forms the greater mass, and the pearlite is re-
ands in a sea of ferrite. With 0.035 per cent of carbon

eton. is reduced to some thin scattered seams in a mass of

CAS 1.20 per cent of carbon the 5 per cent excess cementite
s and C d theoretically be present is represented by the fine
ork, surrounding the dark meshes of pearlite. As the
s to 1.46 and 1.80 this cementite network increases in

e of the cast irons, *I*, *J*, and *K*, the interpretation is more
eed conjectural. With 3.40 per cent of carbon there
st sight to be a still thicker network of excess cementite,
g coarse meshes of pearlite, probably themselves laced
tite.

e of *J* and *K* the interpretation must be extremely cau-
e dark bat-like or hawk-like well-oriented patches may
s a discontinuous early formed network surrounding the
groundmass. There is much to suggest that these black
masses which froze out as austenite along the line *Aa*
more strictly along a line similar to *mea*, and that the
s which they contain, as shown in the higher magnifi-
are the excess cementite born within them on crossing
f. Further, that the zebra groundmass represents super-
ustenite which froze on crossing line *aB*, and was in turn
to pearlite with excess cementite on crossing region VIII.

ra mass, the white stripes should be this excess cementite
rlite See Table 6 should form between 50 and 60 per cent of this
the dark stripes should be pearlite, too fine to be re-
the present magnification.

ing, be present as graphite, especially if the total carbon is high, *i. e.*, especially in case of the cast irons.

156. *Pearlite series.*—Most of the steel of commerce is of the pearlite series; and of this probably at least 95 per cent is hypoeutectoid, *i. e.*, it contains less than 0.90 per cent of carbon, and it therefore consists of pearlite together with free ferrite as the excess-substance. This is true of all common structural steel such as eyebars, I-beams, angles, channels, steel columns, rivets, plates whether for girders, boilers, ships' hulls or other engineering purposes, railroad axles, tires and rails, fence and telegraph wire, sheet steel for tin plate, *etc.*, *etc.* These all consist essentially of a mixture (1) of ferrite and cementite interstratified as pearlite, plus (2) an excess of free ferrite. The proportion of cementite and hence of pearlite which they contain is varied to meet their particular requirements. In general, the greater the need of ductility, the less carbon do they contain, and hence the less of the hard, brittle cementite; in other words, the greater is the percentage of the soft, ductile, free ferrite and the smaller the percentage of pearlite. On the other hand, the greater the strength and the higher the elastic limit needed, the more carbon do they contain, *i. e.*, the larger is the percentage of cementite and hence of pearlite, and the smaller is the excess of free ferrite.

The microstructure of this series, including hyper-eutectoid steel and white cast iron, is shown in Fig. 66.

The proportions of ferrite and cementite and also that of pearlite for the different parts of this pearlite series are given in Table 6, p. 184, and they are also indicated graphically in Fig. 65, p. 185.

157. *The graphito-pearlite or gray cast-iron series.*—Most of the cast irons used as such, *i. e.*, in the form of gray castings for engineering and indeed for industrial purposes in general, are of the second or graphito-pearlite series. Such cast iron generally contains in the neighborhood of 4 per cent of carbon of which some 2.00 to 3.50 per cent is present as free graphite, and the rest as cementite, or "combined carbon." Here belong all gray iron castings, whether for machinery, for piping, for columns, for girders, or other like purposes. In general the greater the need of softness to facilitate cutting to shape, or "tooling," and of malleableness to resist blows and ill-treatment, the smaller is the proportion of combined carbon and hence of cementite, and the

larger that of ferrite; in short the more closely does the ratio of cementite to ferrite approach that of the low-carbon engineering steels.

The iron founder usually looks at the other side of the question. As we cannot eat our cake and keep it, the less carbon is present as cementite the more must be present as graphite if the total carbon is approximately constant, as is usually the case. Hence the greater the softness and malleableness needed, the more graphite is usually present. Hence the founder regards graphite as a source of softness. But this is simply the opposite view of the same fact, and the whole subject is made much clearer if we look at the other side of the shield, and recognize that softness and malleableness are to be had by having the soft and malleable ferrite and the soft graphite instead of the hard, brittle cementite. From this point of view the whole matter is as clear as crystal; from the opposite it is foggy. (See §§ 327 to 332, pp. 431 to 437.)

Without here* developing this view at greater length, let us recognize clearly that, as the gray-cast-iron or graphito-pearlite series as a whole appears to be simply the pearlite or steel-white-cast-iron series plus graphite, so any individual gray cast iron is simply a metallic matrix of steel or white cast iron, as the case may be, in which flakes of a wholly non-metallic and as it were foreign body, graphite, are scattered.

158. THIS CONCEPTION TESTED.—As this conception of matrix plus graphite is essential, we may here see how well it tallies with the grayness itself of this iron, by which we mean the grayness of its fracture. It usually contains some 4 per cent of carbon all told, of which perhaps 3 per cent by weight or about 10 per cent by volume is in the form of flakes of graphite of considerable size, often $\frac{1}{8}$ of an inch across, existing within the iron as a nearly continuous skeleton. When such iron is broken, rupture, following the path of least resistance, travels along the weak faces of the flakes of graphite, instead of through the strong metallic matrix, with the consequence that in the fracture nothing but graphite is seen. But that the graphite which we now see is nothing but a veneering is readily shown by brushing one of these fractures with a wire brush. The flakes of graphite are quickly scraped off, exposing the whiteness of the metallic

* The Author has elaborated this subject in the *Proceedings of the American Society for Testing Materials*, II, p. 246, 1902.

matrix beneath, a whiteness to be sure still stained by the adhering traces of graphite, as our fingers after pencil-sharpening are still stained after we have blown away the powdered graphite shavings.

Of course interspersing a weak, foreign substance like graphite through a metallic matrix of steel must both weaken and embrittle that steel. Hence the relative weakness and brittleness of cast iron; against which are to be weighed, first, its greater cheapness, since all steels are the product of purifying cast iron and hence are more expensive than it; and further the cheapness with which; thanks to its fusibility, fluidity, and expansion when solidifying, it is cast into forms into which the more infusible steel can be cast only with difficulty, and can be forged or rolled only with great outlay of power, and of fuel for heating it to a forging heat.

159. THE AUSTENITE SERIES. — To this belong all forms of hardened, and of hardened and tempered steel, such as cutting tools, whether for cutting wood, metals or other substances, springs, dies, the points of armor-piercing projectiles, and the face of projectile-resisting armor.

As the pearlite and graphito-pearlite series increase in hardness and brittleness as their cementite or "combined" carbon increases, so does the austenite series as its carbon-content increases. Whence we may generalize and say that each of these three series increases in hardness and brittleness as its combined-carbon-content increases. But increasing carbon-content increases the hardness and brittleness of the austenite state far more than that of the pearlite state. Thus the hardness and ductility of low-carbon steel, say of 0.10 per cent of carbon is but slightly affected by sudden cooling; whereas steel of say 0.50 per cent of carbon, while it can be bent double without cracking when cooled slowly, *i. e.*, when in the pearlite state, yet when in the hardened, *i. e.*, suddenly cooled or austenite state it can take no appreciable permanent set before breaking. Fig. 67 illustrates this.

Much the same is true of the hardness proper, the resistance to abrasion and indentation. When slowly cooled, *i. e.*, in the pearlite state, the hardness of such steel is about what should be expected in view of its ductility. It is indeed harder under the file than low-carbon steel, but the difference is not a conspicuous one. But whereas very low-carbon steel when suddenly cooled

is not appreciably harder than when cooled slowly, high-carbon steel (of say 1.25 per cent of carbon) when suddenly cooled is so hard as to scratch glass.

In short the hardening power, whether measured by the hardness or by the brittleness induced, increases with the carbon-content.

160. USES OF THE AUSTENITE SERIES. — Although there are very many and very varied uses for the austenite series, yet the actual quantity of metal used for most of them is relatively small, when compared with the enormous quantities of the pearlite and

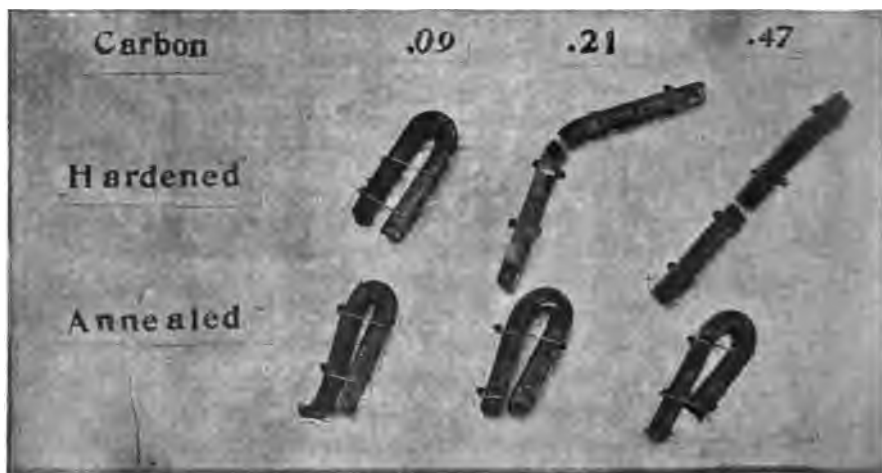

Fig. 67. The Hardening Power Increases with the Carbon-content.

graphite-pearlite series in use. Not only is the sudden cooling, upon which the preservation of the austenite state depends, in itself expensive because of the care which it requires, but the metal itself is brittle, both from its very nature and from the stress which the sudden and hence unequal cooling induces. Hence members of this series are in general used only where their hardness (cutting tools, dies, projectiles and armor) or their high elastic limit (springs) is indispensable; and in many cases the brittleness which accompanies this hardness has to be specially guarded against by putting only one part of a given object into this austenite condition, and uniting this brittle part

integrally with a backing, which is in the ductile pearlite state. Thus the cutting edge of a cold-chisel is hard and brittle because it is in the austenite state thanks to its sudden cooling, *i. e.*, hardening; and this brittle edge is prevented from breaking by its integral union with the shank of the chisel, the temperature of which has been so manipulated as to leave the metal in the pearlite state, malleable and relatively stressless. So with the hardened point of a projectile, integrally united with its unhardened body; the hardened face of the armor-plate integrally united with a back of low-carbon steel, which, even in the austenite state, is relatively malleable.

161. THE AUSTENITE NEVER PURE. — It is true that these objects are, more accurately speaking, intermediate between the austenite and the pearlite state, as has been pointed out in § 149, p. 179, *i. e.*, they never consist solely of pure unaltered austenite. Even in objects which are used in the suddenly cooled or hardened state without subsequent drawing of the temper, the austenite is more or less altered, because no cooling, however rapid, can completely prevent its alteration towards the condition of pearlite. In the more common cases such as springs and most cutting tools, in which the suddenly cooled object is afterwards slightly tempered by slight reheating, the change from the austenite towards the pearlite state goes still further. Nevertheless, for our present purpose we may regard all these objects as of the austenite series in the broad sense that we owe their properties chiefly to their austenite.

162. FREEZING-POINT CURVES AND TRANSFORMATION CURVES OF THE IRON-CARBON COMPOUNDS. — The inflections which we have studied in Chapter II in our cooling curves are due to the liberation of heat, or in other words to the change of energy in passing from the molten to the solid state. But as was pointed out in § 12, p. 19, every change, chemical or physical, within the metal after it has solidified will probably be accompanied by the evolution (or more rarely by the absorption) of heat, and these will in like manner cause inflections in the cooling curves, which thus will record automatically not only the progress and method of solidification, but also all changes of constitution which take place in cooling from the freezing-point downwards. And this brings us by an easy stage to Roberts-Austen's diagram (Fig. 68) which shows us simultaneously the freezing-point curves and the trans-

formation curves of the iron-carbon compounds, as well as the constitution corresponding at different temperatures to these different percentages of carbon.

Regarded in a broad way, this diagram really consists of two sets of the familiar underscored V curves, of the family which as we have seen, habitually represents the freezing of a eutectiferous alloy.

The first or upper set, *ABC, aBc*, indeed represents the freezing of just such a eutectiferous series, for that is what the iron-carbon compounds really are. The eutectic contains about 4.30 per cent of carbon, and its two constituents are (1) the solid solution of carbon in iron, austenite, and (2) graphite. The austenite should normally be saturated with carbon, in short a saturated solid solution, like those in other eutectics. About 2.00 per cent of carbon should saturate it.

Eae is clearly a fragment of the saturation-point or critical curve, showing the supposed percentage of carbon which at each temperature suffices to saturate the austenite.

The second or lower set, *GHSE, PSP'*, represents a parallel transformation within the solid metal, closely comparable with the freezing of a eutectiferous alloy. That is to say, just as the freezing of a series of eutectiferous alloys yields a series of conglomerates, each consisting of the eutectic plus an excess-substance; so this transformation within the solid metal in cooling causes the solid solution, austenite, to break up into a conglomerate consisting of a quasi-eutectic or "eutectoid" plus an excess-substance. And as in the freezing of a eutectiferous alloy this transformation from molten solution to solid conglomerate takes place along this underscored V set of lines, so this present transformation within the solid austenite, the solid solution, takes place along this underscored V set of lines.

The eutectoid or quasi-eutectic is pearlite, and its constituents are ferrite, Fe, and cementite, Fe C.

The Terms Ar₁, Ac₁, etc. — These are explained in § 192, p. 215.

The present diagram, like similar ones for other series of alloys, represents the freezing-points as distinguished from the melting-points, and the transformation-points in cooling as distinguished from heating. The corresponding lines for rising temperature and for melting should theoretically coincide with these;

actually owing to lag there are considerable discrepancies. (See § 164.)

In general the meaning and indeed the position of the lines to the right of the 1.50 per cent carbon ordinate are by no means well established. In particular, since the first edition of this book was written grave doubts have been thrown upon the then accepted interpretation of the line *BC*, which may represent the formation of cementite.

163. POSITION OF THE STEEL CAST-IRON BOUNDARY AS RELATED TO THE SATURATION-POINT OF SOLID AUSTENITE. — Just as it is in general desirable that the boundaries of countries should be natural ones, such as mountain ranges or bodies of water, so it is desirable that our different classifications of iron and steel should as far as practicable be based on such natural divisions, instead of being purely arbitrary. In this work the dividing line between cast iron and steel has been arbitrarily drawn at 2.00 per cent of carbon, in rough accordance with commercial usage. But this arbitrarily chosen line has the advantage of being very near to the great natural division between the normally non-eutectiferous range and the normally eutectiferous range. So soon as the position of this natural boundary has been determined with reasonable accuracy, it may be well to adopt it as the dividing line between steel and cast iron. Steel would comprise the normally non-eutectiferous and cast iron the normally eutectiferous carbon-iron compounds.

While this plan is attractive in case of pure iron-carbon compounds, it may not be practicable to apply it to impure irons, for the reason that the boundary of the eutectiferous range may shift widely with variations in the proportions of the impurities. Should this be the case, then instead of such a precise basis of demarcation we may have to use the vaguer one adopted in § 142, p. 170, according to which the distinction between those steels which approach cast iron in nature and those cast irons which approach the nature of steel is that steel must be forgeable in at least some one range of temperature, while the cast iron is not.

164. GENERAL DIVISION; CONSTITUTION; LAG. — This diagram is divided by these freezing-point and transformation-point lines into nine important regions. To each of these, according to our present theories, a certain constitution normally corresponds. As the metal cools from one of these regions into another,

its constitution ought theoretically to change from the theoretical constitution of the region it is leaving to that of the region which it is entering. But owing to what we may call lag or molecular inertia, these transformations which should occur on crossing such a boundary may be suppressed partly, and perhaps even completely. In other words, these transformations, especially those which occur within the solid metal, require a certain length of time; and they are opposed by the cold; so that if the cooling across a given boundary is rapid, the transformation due at that boundary may be incomplete there, and if the temperature falls quickly to the cold, this transformation may be permanently arrested, and thus remain permanently incomplete.

This lag is a matter of very great importance, and to it we are in large part indebted for our power of giving to a given piece of steel or cast iron a great variety of different properties by different methods of heat-treatment. These methods act chiefly by inducing certain desirable degrees of lag, or by stimulating some reaction which has already lagged, and thus reviving it under favorable conditions. We shall in due time see that this is true of the hardening, tempering and annealing of steel, the chilling and annealing of cast iron, and the manufacture of malleable iron castings.

One effect of this tendency to lag is to cause transformations represented by these different lines of Fig. 68 to take place in cooling at temperatures considerably below what may be called the theoretical temperatures, and in particular below the temperatures at which they occur during rise of temperature. There is also a certain amount of lag during rise of temperature, but this is generally much less marked.

Hence the observed position of the transformation lines in cooling may actually be much lower than that observed during rise of temperature.

Certain foreign elements, such as nickel and manganese, appear to act through lowering the temperatures at which these transformations occur, and a large part of the important influence of these foreign elements has been referred to their thus lowering these temperatures.

These nine regions will now be enumerated, and at the same time their theoretical constitution and the transformations which should theoretically occur in cooling through them will be given.

Equations will be given representing these transformations, and these equations will be grouped together in Table 8, p. 203.

165. REGION I, *ABCF*, MOLTEN SOLUTION OF CARBON IN IRON. — This has for its lower boundary the upper freezing-point curve *ABC*; and it represents simply molten steel and molten cast iron, each of which is a molten solution of carbon in iron. The boundary between them is imaginary. It will simplify our ideas if we assume that when solid iron containing graphite melts, the graphite in melting loses completely its graphitic nature, and becomes simply carbon dissolved in iron, exactly as if before fusion it had existed in solution or combination, instead of as graphite.

166. REGION II, *AaB*, *Selective Freezing Occurs*, MOLTEN CARBURETTED IRON AND SOLID AUSTENITE. The metal in this region consists of (1) solid austenite, a solid iron-carbon solution, the excess-substance, together with (2) the mother-metal of molten carbon-iron solution.

The theoretical reactions on cooling through this region are as follows:

A. For all compositions at the left of the 2.00 per cent carbon ordinate (line *ea*), selective freezing:

(1) molten solution = solid austenite.

B. For compositions between 2.00 and 4.30 per cent of carbon, in cooling through this region, down to but not including the transit across the lower boundary, *aB*, selective freezing:

(2) molten solution = solid 2.00 per cent austenite + molten eutectic.

(By 2.00 per cent austenite is meant austenite containing 2.00 per cent of carbon dissolved in it.)

On crossing the lower boundary *aB*, freezing of the eutectic:

(3) molten eutectic = solid eutectic = 2.00 per cent austenite + graphite.

Taking both the passage down to the lower boundary and the crossing of that boundary, the sum of reactions (2) and (3) may be written thus:

(4) molten solution = 2.00 per cent austenite + graphite.

This transformation from molten solution into graphite appears to be relatively slow, unless stimulated by the presence of silicon. Hence if the metal is free or nearly free from silicon and

is cooled at any usual rate, the resultant austenite may contain much more than 2 per cent of carbon. Instead of reaction (4) we then have:

(5) molten solution = supersaturated austenite + graphite,
or

(5) molten solution = (2 +) per cent austenite + graphite.

It is probably to this suppression of the formation of graphite, this substitution of reaction (5) for reaction (4), that we are indebted for the existence of white cast iron.

167. REGION III, *CBC*, *Selective Freezing Occurs*, MOLTEN CARBURETTED IRON AND GRAPHITE. — The mass in this region probably consists of (1) solid graphite, the excess-substance, together with (2) the still molten mother-metal of iron-carbon solution.

The theoretical reactions in this region are as follows:

In cooling through this region, down to but not including the transit across its lower boundary *Bc*, selective freezing:

(6) molten solution = molten eutectic + graphite.

On crossing the lower boundary *Bc*, freezing of the eutectic:

(3) molten eutectic = solid eutectic = 2.00 per cent austenite + graphite.

Taking both the passage down to the lower boundary and the crossing of that boundary, the sum of reactions (6) and (3) may be written thus:

(4) molten solution = 2.00 per cent austenite + graphite.

The remarks as to the lagging of reaction (4) made in case of region II apply here also, so that reaction (5) is probably substituted for the theoretical reaction (4) in most cases.

168. REGION IV, *AaESHK'G*, AUSTENITE, solid iron-carbon solution, resulting from reaction (1). Theoretically no transformation should occur in cooling through this region.

169. REGION V, *GHSP*, *Selective Transformation Occurs*, AUSTENITE AND FERRITE. — Ferrite as the excess-substance, and austenite the still untransformed solid mother-metal. Above the line Ar_2 the ferrite is *beta*, below it is *alpha*. (See § 191, p. 214.)

To explain, just as in selective freezing the excess-substance progressively freezes out, and the remaining molten mother-metal correspondingly approaches the eutectic ratio, so in cooling through this region, iron which may be regarded as the excess-substance,

progressively separates* in the free state, *i. e.*, as ferrite, within the solid red-hot austenite, which consequently becomes enriched in carbon, and approaches the "hardnite" or quasi-eutectic or eutectoid ratio of 0.90 per cent of carbon, reaching it when the temperature in falling reaches the eutectoid transformation-temperature *PSP'*. The reaction may be written

(7) austenite = hardnite + ferrite, or

(7) austenite = 0.9 per cent austenite + ferrite.

And just as, when the temperature falls past the eutectic freezing-point, this eutectic in turn breaks up into its constituents; so here when the temperature falls past the eutectoid transformation-temperature, the remaining untransformed solid mother-metal is now transformed into ferrite and cementite, interstratified as pearlite. The reaction may be written

(8) hardnite = pearlite = ferrite + cementite, or

(8) 0.9 per cent austenite = pearlite = ferrite + cementite.

The sum of these transformations (7) and (8), the progressive transformation in region V plus the transformation of the eutectoid on leaving this region, may be written thus:

(9) austenite = ferrite + cementite.

The whole of the cementite is interstratified with ferrite as pearlite in the ratio of 1 : 6, and the remainder of the ferrite in excess of this ratio is the excess-substance, the "structurally free ferrite" of Sauveur.

170. REGION VI, *PSH'O*, PEARLITE AND FERRITE resulting from reaction (9).—Of these ferrite is the excess-substance, and pearlite the eutectoid, or quasi-eutectic. Theoretically no reaction occurs in cooling through this region.

171. REGION VII, *aERc*, 2 PER CENT AUSTENITE AND GRAPHITE resulting from reaction (4).

Our theories as to this region still lack proof: they must therefore be accepted very cautiously.

* When it is said that ferrite "separates" within the solid austenite, it is not meant that this ferrite removes itself bodily away from the mother austenite; the little particles of ferrite as it were remain in the womb which conceives them, for the simple reason that the degree of plasticity of this red-hot austenite, while sufficient to enable the ferrite made free by reaction (7) to unite into particles large enough to be detected by the microscope, is yet far too slight to permit those microscopic particles to remove themselves out of the mother-mass.

Part of the austenite and part of the graphite are associated as the eutectic, which as already pointed out is a mixture of graphite with saturated austenite, and contains 4.30 per cent of total carbon.

At the left of the eutectic ordinate the mass is a conglomerate of the eutectic plus the excess-substance, austenite; at the right of this ordinate it is a conglomerate of the eutectic plus the excess-substance, graphite.

As already explained, owing to the lag of reactions (1) to (4) the austenite may contain more than 2 per cent of carbon, *i. e.*, may be supersaturated, especially if there is but little silicon present, an element which appears to stimulate reaction (4), or at least to stimulate the passage of carbon into the state of graphite.

Theoretically no reaction occurs in cooling through this region.

172. REGION VIII, *ESP'R Selective Transformation Occurs*, AUSTENITE AND CEMENTITE. — GRAPHITE also is habitually present through lag, though theoretically absent. Cementite is the excess-substance, and austenite the still untransformed solid mother-metal. This region thus mates region V; region VIII is hyper-eutectoid, region V is hypo-eutectoid.

Our theories as to this region still lack proof: they must therefore be accepted very cautiously.

An extremely important reaction occurs theoretically on entering this region, *i. e.*, on cooling past the line *ER*. The graphite existing in region VII should, on crossing this line, react with part of the iron of the austenite which accompanies it to form cementite, thus:

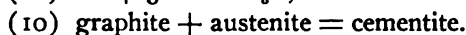
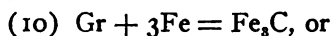

The sheets of graphite which exist in region VII are naturally those with which we are familiar in gray pig iron, coarse, thick, and at a considerable distance apart. Now it is relatively easy for the graphite to react with the molecules of iron in the layer of austenite with which it is in immediate contact. But these molecules are by no means enough to convert the whole of that graphite into cementite by reaction (10). The rest of the graphite cannot undergo that reaction unless it can, through molecular migration or otherwise, actually reach the molecules of iron in other layers

of austenite with which it is not initially in contact. Hence it is not surprising that reaction (10) should lag, and should indeed habitually be extremely far from complete; in short that most of the graphite which we have reason to believe exists in region VII is habitually found in the cold cast iron, passing undecomposed through regions VII, VIII, and IX. Hence the existence of gray cast iron.

Because the austenite of the eutectic as it comes into existence at the end of the freezing, *i. e.*, on cooling past line aBc , should theoretically be saturated with carbon, and because reaction (10) should remove iron from that austenite, the austenite should thereby become supersaturated with carbon. To meet this condition, we may suppose that this supersaturation will, if equilibrium is reached, cure itself by a further combination of part of the carbon and part of the iron of the austenite to form more cementite.

Returning now to the selective transformation which occurs on cooling through this region down to but not across line SP' , it of course consists in the progressive formation of more and more cementite within the solid red-hot austenite, by the union of part of its iron and part of its carbon. The reaction may be written:

(11) 2 per cent austenite = hardenite + cementite, or

(11) 2 per cent austenite = 0.9 per cent austenite + cementite.

As cementite contains 6.67 per cent of carbon, or much more than the austenite itself, this formation of cementite progressively impoverishes the austenite in carbon until it eventually reaches the hardenite or eutectoid composition of 0.90 per cent of carbon, simultaneously reaching the eutectoid transformation temperature. On cooling past this point, the remaining austenite, now called hardenite, in turn transforms into pearlite. The reaction may be written:

(8) hardenite = pearlite = ferrite + cementite, or

(8) 0.90 per cent austenite = pearlite = ferrite + cementite.

The sum of these transformations may as in case of region V be written thus:

(12) 2.00 per cent austenite = ferrite + cementite

Or, taking reactions (10), (11), and (8) collectively, the end reaction for the total journey through this region, including both upper and lower boundary, may be written:

(13) 2.00 per cent austenite + graphite = ferrite + cementite, or

(13) 2.00 per cent austenite + graphite = pearlite + cementite.

173. REGION IX, *SP'fh'*, PEARLITE AND CEMENTITE. — GRAPHITE also is habitually present through lag, though theoretically absent. The pearlite and cementite result from reaction (9) which occurs in crossing and leaving region VIII. The graphite is that which formed in freezing, and failed to be converted into cementite by reaction (10) on crossing *EB'R*.

Theoretically no reaction occurs in cooling through this region.

Our theories as to this region still lack proof: they must therefore be accepted very cautiously.

174. SUMMARY. — First there are two very important regions, the austenite region above *GSER*, and the ferrite and cementite or pearlite region below *PSP'*.

Next there are two transition regions, the upper, including the selective freezing regions II and III and the lower including the selective transformation regions V and VIII.

Beyond this the austenite region may be divided into two parts, region VI, the non-graphitiferous, and region VII, the graphitiferous. The graphite of region VII through lag habitually persists in cooling and is present in regions VIII and IX except in their left-hand parts, to the left of the line *eaEd*.

The several reactions which have been given in the preceding sections, 165-173 inclusive, are here summed up in Table 8.

Having thus studied as it were the geography of the iron-carbon compounds in a general way, let us pass on to consider certain features in more detail, particularly with the aim of finding the correspondence between the transformations in the freezing and cooling of the iron-carbon compounds, and the transformations in the freezing of other alloys, as set forth in Chapters II to V inclusive.

175. THE FREEZING-POINT CURVE, *ABC, aBc*; ITS GENERAL FEATURES. — The left-hand part *AB, aB* is evidently of the family of the freezing-point curve of the bismuth-tin alloys, of the limited solubility type, Figs. 33 and 49, pp. 75 and 136, eutectiferous in the middle but not at its ends. The right-hand side of the diagram here given stops short at about 5.70 per cent of carbon; if

TABLE 8. — *Tabular Statement of Reactions in the Freezing and Transformation of the Iron-carbon Compounds.*

THE REACTION	THE REACTION IS THE THEORETICAL ONE, OR IS DUE TO LAG	CLASS TO WHICH THE REACTION APPLIES	REGION TO WHICH THE REACTION APPLIES*
Freezing	(1) molten solution = solid austenite	hypo-eutectic	II
	(2) molten solution = solid 2% austenite + molten eutectic	hypo-eutectic	II
	(3) molten eutectic = solid eutectic = 2% austenite + graphite	hypo- and hyper-eutectic	(II-VII),* (III-VII)
	(4) [(2) + (3)] molten solution = 2% austenite + graphite	hypo- and hyper-eutectic	II, (II-VII) III, (III-VII)
	(5) molten solution = supersaturated austenite + graphite, or	hypo- and hyper-eutectic	"
	(6) molten solution = (2 +) % austenite + graphite	hypo- and hyper-eutectic	III
Transformation	(7) austenite = hardenite + ferrite, or	hypo-eutectoid	V
	(7) austenite = 0.9% austenite + ferrite	hypo-eutectoid	V (V-VI) (VIII-IX)
	(8) hardenite = pearlite = ferrite + cementite, or	hypo- and hyper-eutectoid	"
	(8) 0.9% austenite = pearlite = ferrite + cementite	hypo- and hyper-eutectoid	V, (V-VI) VIII, (VIII-IX)
	(9) [(7) + (8)] austenite = ferrite + cementite	hypo- and hyper-eutectoid	" (VII-VIII)
	(10) Gr + 3Fe = Fe ₃ C, or	hyper-eutectoid.	"
	(10) graphite + austenite = cementite	hyper-eutectoid.	VIII
	(11) 2% austenite = hardenite + cementite, or	hyper-eutectoid.	"
	(11) 2% austenite = 0.9% austenite + cementite	hyper-eutectoid.	"
	(12) [(11) + (8)] 2% austenite = ferrite + cementite	2% carbon or more	VIII, (VIII-IX)
	(13) [(10) + (11) + (8)] 2% austenite + graphite = ferrite + cementite, or	2% carbon or more	(VII-VIII) VIII, (VIII-IX)
	(13) 2% austenite + graphite = pearlite + cementite	2% carbon or more	"
	(14) molten x% solution = x% austenite	Lag	—

* By Region II-VII, III-VII, etc., is meant the boundary between regions II and VII, III and VII, etc.

completed the diagram would of course run from carbon 0, iron 100, on the left, to iron 0, carbon 100, on the right. As to the prolongation of this freezing-point curve to the right beyond carbon 5.50 per cent we have little information; our attention thus is confined to what is really but a fragment of the whole freezing-point curve.

The known part of the right side of this diagram is apparently not of the limited solubility but of the complete insolubility type, which was assumed for simplicity for the salt-water and lead-tin cases (§§ 21, 48, pp. 26 and 62). Thus taking the freezing-point curve ABC , aBc as a whole, its two sides are of different types, the left being of the limited solubility, bismuth-tin type, while the right is of the complete insolubility, salt-water and lead-tin type.

B is evidently the eutectic, corresponding to 4.30 per cent of carbon, and 95.70 per cent of iron. AB is the upper freezing-point curve when iron is the excess-metal, *i. e.*, when carbon is below 4.30 per cent and iron above 95.70 per cent, austenite (the solid solution of carbon in iron) beginning to freeze out when the temperature falls to any point on this line. BC is the upper freezing-point curve when carbon is the excess-substance, *i. e.*, when carbon is above 4.30 per cent and iron below 95.70 per cent, carbon in the form of graphite beginning to freeze out when the temperature falls to any point on this line.

176. REGIONS IV AND VII, CONSTITUTION OF IRON AT 1050° IN THE DIFFERENT RANGES OF COMPOSITION. Let us assume that the temperature has fallen from the molten state to say 1050° , so that the freezing is complete, the metal is solid throughout, but that the transformations represented by the transformation group of lines $GSER$, PSP' have not yet begun; and let us consider the constitution.

(1) *Region IV, Non-Eutectiferous or Steel Range.* In this region the red-hot or even white-hot metal consists essentially of austenite, the solid solution of carbon in iron, its concentration or in other words its carbon-content increasing progressively as we pass from left to right. When of the eutectoid composition, carbon 0.90 per cent, it is sometimes called *hardinite*.

177. (2) *The Eutectic*, of which cast iron containing 4.30 per cent of carbon consists at this temperature, is intermediate in character between the eutectic of the bismuth-tin or of the

metals *H* and *G*, or limited solubility type of alloys, and that of the lead-tin or complete insolubility type. It of course consists of alternate particles of its two constituents. Its left-hand member, austenite, corresponds to the saturated solid solution, saturated bismuth-bearing tin, of the tin-bismuth eutectic, and should for this reason be a solid solution of iron saturated with carbon, *i. e.*, saturated austenite. Its right-hand member, graphite, corresponds to the assumed lead-less tin at the right-hand of Fig. 24, p. 54. At least the graphite appears to be wholly free from iron; and if not wholly free, is at least nearly free; so that solid iron is certainly very nearly and perhaps quite insoluble in solid carbon. But in either case we may regard this graphite as a saturated solid solution of iron in carbon; since, algebraically speaking, zero per cent of iron would saturate carbon if this insolubility of iron in carbon should prove to be complete.

178. (3) REGION VII, EUTECTIFEROUS OR CAST IRON RANGE. — Just as points between *a* and *B* and *c* in Figs. 33 and 49 represent a conglomerate of the eutectic plus the excess-metal, bismuth or tin and metal *H* or metal *G*, as the case may be, saturated or not according to whether diffusion has or has not effaced the initial heterogeneousness; so here hypo-eutectic cast iron containing between about 2 and 4.30 per cent of carbon is a conglomerate of (1) the eutectic and (2) the excess-substance, austenite, a solid solution of carbon in iron, saturated or not according to whether diffusion has or has not effaced the initial heterogeneousness of deposition; while hyper-eutectic cast iron containing over 4.30 per cent of carbon is a conglomerate of this same eutectic plus the now excess-substance, carbon, in the form of graphite.

Recapitulating, since at this temperature all cast iron, *i. e.*, all iron containing over about 2 per cent of carbon, is the eutectic (austenite + graphite) either alone or plus austenite or plus graphite, so it is all a conglomerate of austenite plus graphite. The truth of this statement is not affected by the fact that part of these two substances is intermixed as the eutectic, which in turn is intermixed with an excess of one or the other.

If he would avoid confusion, the beginner should here clearly recognize that in any hyper-eutectic cast iron, say in one containing 5 per cent of carbon and 95 per cent of iron, the carbon is the excess-substance and the iron the deficit-substance, in that the

carbon is present in excess over the eutectic ratio, and the iron is below that ratio; and this is true in spite of the fact that the percentage of iron is 19 times as great as that of carbon, and that there are about four times as many atomic equivalents of iron as of carbon present. (See § 34A, p. 40.)

As already pointed out, theoretically the austenite should be exactly saturated. If, to fix our ideas, we assume that 2 per cent of carbon just suffices to saturate it, then the percentage of graphite present should simply be whatever excess of carbon is present above this 2 per cent. But in freezing the carbon appears reluctant to pass from its initial state of solution into that of graphite (reaction (4), Table 8) and to tend rather to remain in solution after freezing. In other words, the passage of the carbon from the state of solution into that of graphite appears to lag, so that the austenite often contains much more than 2 per cent of carbon, and thus appears to be far supersaturated.

179. GENESIS OF THIS 1050° CONSTITUTION. — Let us next consider how the constitution which exists in regions IV and VII comes into existence; and let us follow in Fig. 68 the cooling, from 1600° to 1050°, of typical kinds of iron, *i. e.*, of different irons each containing a typical percentage of carbon. Let us select (1) eutectic cast iron, (2) steel of 1 per cent of carbon, (3) hypo- and (4) hyper-eutectic cast iron. For simplicity we will ignore lag, and assume that the transformations complete themselves as they fall due.

For the purpose now in hand it is well to remember that this steel which we are about to consider differs essentially from these several cast irons in that it is non-eutectiferous, while they are eutectiferous, at least theoretically.

180. (1) 4.30 per cent. *Eutectic cast iron* with 4.30 per cent of carbon undergoes but one change, its freezing and simultaneous splitting up into its alternate plates of graphite and of saturated austenite at temperature *B* (1130°). The cooling curve is like that of any other eutectic, Figs. 10 and 28 *E*, and the correspondence is as follows:

Fig. 28*E*

AC
CD
DE

Fig. 68

Q''B
B
BB'

Molten eutectic cast iron cools.
It freezes at constant temperature.
The solid eutectic cast iron cools.

181. (2) 1.00 per cent. *Steel of 1 per cent of carbon, (Q),* on cooling to q on the line AB begins to freeze selectively quite like our alloy of metals H and G , q in Fig. 49. The first freezing layer or nucleus has composition p ; and, as the temperature further falls the temperature and composition of the mother-metal slide along AB from q to s as it becomes progressively enriched in carbon by the selection; those of the layers in the act of depositing slide from p to s as they become correspondingly enriched in carbon, following a line somewhere near the ps here sketched; and those of the frozen mass (assuming that diffusion effaces the initial heterogeneity of deposition), slide simultaneously along Aa from p to r as it too becomes progressively richer in carbon; or, if diffusion is incomplete, then by some other path to some point necessarily on the ordinate QW , since the final composition of the wholly frozen mass must be that of the initial molten metal, $Q = 1$ per cent.

The cooling curve is like that of Fig. 30, p. 71, the correspondence being as follows:

Fig. 30 Fig. 68

AB	Qq	Molten steel cools.
BC	qr	It freezes selectively forming unsaturated austenite.
CE	rr'	Solid steel cools.

182. (3) 2.50 per cent. *The cooling of hypo-eutectic cast iron,* containing say 2.50 per cent of carbon, Q' , is like that of a eutectiferous alloy of limited reciprocal solubility when solid, n , Fig. 49. On cooling to n (1280°), as before, selective freezing begins with the freezing out of austenite, and the temperature and composition of the mother-metal slide from n to B as selection enriches it: those of the layers in the act of freezing slide from m to e , thence to a , and thence skip to B , as they pass successively through the stages of (1) unsaturated austenite, (2) saturated austenite, and (3) the eutectic; while those of the frozen mass as a whole slide from m to a , as a solid solution; they then slide from a to B as a conglomerate of austenite and eutectic. The cooling curve is like that of Fig. 31, and the correspondence is as follows:

Fig. 31 Fig. 68

<i>AB</i>	<i>Q'n</i>	Molten hypo-eutectic cast iron cools.	} Selective Freezing period.
<i>BB'</i>	<i>nn'</i>	Unsaturated austenite freezes.	
<i>B'C</i>	<i>i:n''</i>	Saturated austenite freezes.	
		Subsaturation division:	
		Saturation division:	
<i>CD</i>	<i>i."</i>	The eutectic freezes at constant temperature.	
<i>DE</i>	<i>i".i'''</i>	The wholly frozen hypo-eutectic cast iron cools.	

183. (4) 5.00 per cent. *The cooling of hyper-eutectic cast iron*, finally, is like that of our salt-water solution and lead-tin alloys, the components of which we assumed for simplicity to be wholly insoluble in each other. Selection then is rigid, the excess-substance, carbon (which when the mass was molten would be regarded by some as the solvent), freezing out wholly free from the deficit-substance, iron.

During the selective period of the freezing, *TT'*, then, it is pure graphite which freezes out, the mother-metal becoming correspondingly enriched in iron, *i. e.*, impoverished in carbon, its temperature and composition sliding from *T'* to *B*, and its carbon-content falling to the eutectic ratio of 4.30 per cent and simultaneously reaching the eutectic freezing-point of 1130°. Now begins the unselective or eutectic-freezing period, during which the mother-metal in freezing forms the eutectic.

The mass when wholly frozen, then is a conglomerate of (1) graphite frozen out between *T'* and *T''* and (2) the eutectic frozen out at *T''*.

The cooling curve is like that assumed for ice, lead, and tin, Figs. 8, 28 *B* and 28 *F*, and the correspondence is as follows:

Figs. 28*B* and 28*F* Fig. 68

<i>AB</i>	<i>TT'</i>	Hyper-eutectic molten cast iron cools.
<i>BC</i>	<i>TT''</i>	Graphite freezes out, selective period.
<i>CD</i>	<i>T''</i>	The Eutectic freezes out at constant temperature, <i>T''</i> .

184. CONDITIONS AFFECTING THE QUANTITY OF GRAPHITE FORMED. — It is a familiar fact that the presence of silicon favors the formation of graphite. All carbon in molten cast iron may be regarded as combined with or dissolved in the iron, because otherwise it would rise to the surface. Of this carbon a variable amount turns into graphite during cooling, the proportion increasing (1)

with the slowness of the cooling, and (2) with the silicon-content of the metal, at least until this latter reaches 0.75 per cent,* but diminishing with the sulphur-content, and under certain conditions with the manganese-content. In foundry parlance, iron either nearly free from silicon, or rich in sulphur or manganese, is apt to be "white," *i. e.*, its fracture reveals little or no graphite; but iron containing at least a moderate proportion of silicon, especially if it is relatively free from sulphur and manganese, is usually gray, *i. e.*, its fracture passes along the plates of graphite which have formed within it during solidification.

So, too, other things equal, the more slowly cast iron is cooled, the grayer it is, *i. e.*, the more graphite is seen in its fracture, because the slowness of cooling favors the formation of graphite during freezing and especially favors its crystallizing in large plates, which readily determine the path of rupture; and hence are the more prominent in the fracture.

The fact that slow cooling stimulates the formation of graphite may reasonably be explained by its giving greater opportunity for the lagging reaction (3) [or (6)] to take place. But it is probably the slow cooling through the freezing-range, and also through region VII, which should stimulate the formation of graphite; and slow cooling through region VIII should lessen the percentage of graphite, by increasing the opportunity for reaction (10), also a lagging reaction, to take place.

These effects of silicon, sulphur, and the rate of cooling are in iron foundry practice played against each other, in order to give to the castings of cast iron the percentage of graphite desired, and through this to ensure their having the proper constitution, *i. e.*, the proper ratio between ferrite and cementite in their matrix. Thus if the percentage of sulphur is greater than usual, the percentage of silicon should be increased. Again, if the castings are going to cool rapidly, either (1) because they are to be thin, or (2) because they are to be cast in green (*i. e.*, moist) sand moulds, or even in iron moulds, instead of in baked (*i. e.*, dried), sand moulds, then since this rapid cooling will tend to restrict the formation of graphite by reaction (3) [or (6)], the percentage of silicon in the iron should be increased so as to offset this, by stimulating the formation of graphite.

*The author, *Trans. Am. Inst. Mining Engineers*, XXX, p. 731, 1900.

185. THE ROLE OF SILICON is not yet clearly established, though Tiemann's* results, as well as Royston's,† indicate that it has a direct stimulating effect on the formation of graphite. But the phenomena of the blast-furnace casting house suggest that, beyond this, silicon probably shifts the eutectic composition to the left, and sulphur probably shifts it to the right, as will now be explained.

In hypo-eutectic cast iron, the formation of graphite should occur only when the metal has cooled down to the eutectic freezing-point, *i. e.*, after the austenite which forms during selective freezing, say from n to n'' , has already frozen; in short after the metal has so far frozen that the graphite as it forms could hardly be expected to separate by gravity, because it would be greatly entangled in the already frozen austenite. But in case of eutectic and hyper-eutectic cast iron, graphite forms in the very first freezing, and therefore at a time when not enough of the metal should have frozen to entangle and mechanically retain the graphite, which is so light that its tendency to remove itself bodily out of the metal by gravity is very great. The great difference in density puts this case into sharp contrast with those of most alloys, in which, as pointed out in § 37, p. 44, the difference in density between the different constituents is too slight to cause perceptible stratification.

Now when cast iron is stored in the great mixers of the blast-furnace casting-house, it is very close to its upper freezing-point, and it is often so cool as to suggest strongly that it is below that point, so that a considerable amount of selective freezing occurs. Indeed a thick crust often forms. Under these conditions a large quantity of graphite rises to the surface of the molten cast iron and is blown thence about the building. This is true even when the iron contains considerably less carbon than the proportion here given as the eutectic ratio, *viz.*, 4.30 per cent. This separation of graphite, and indeed the very presence of this graphite, indicate that the selective freezing which is occurring is the formation of graphite; and this in turn indicates that the metal is hyper-eutectic, in spite of having less than 4.30 per cent of carbon. This, however, implies that the eutectic carbon-content, instead of

* *Metallographist*, IV, pp. 313, 319 to 321.

† *Journ. Iron and Steel Inst.*, 1897, I, p. 166.

being 4.30 per cent, is a considerably smaller quantity, or in short that the silicon which such cast iron always contains has shifted the position of the eutectic to the left.

The fact that, if cast iron contains much sulphur, no graphite is seen blowing about the casting-house, is quite in accordance with this supposition, for this is just the result which we should expect if sulphur were to shift the eutectic position to the right, quite as we have supposed that silicon shifts it to the left.

The fact that cast iron which contains silicon often has very much less than 2 per cent of its carbon in the combined state as cementite, suggests that the presence of silicon has the further effect of shifting the saturation-point line *Eae* to the left. For if the theoretical reactions were to take place to their full extent there should be in the cold cast iron at least enough carbon as cementite to have saturated the austenite when the cast iron was in region VII. Any lag of the transformations would seem to work in the opposite direction of increasing the percentage of carbon as cementite above this saturation ratio rather than in the direction of reducing it below this saturation ratio.

Thus, (1) the fact that such cast iron, though containing all told perhaps 4.00 or 4.50 per cent of carbon, contains very much less combined carbon, very much less carbon as cementite, than would saturate the austenite if its saturation-point were in the neighborhood of 2.00 per cent, together with (2) the fact that such cast iron ought to contain enough combined carbon to have saturated that austenite at the time when it existed, — these facts jointly suggest strongly that the silicon has lowered the saturation-point of the austenite, or in other words has shifted the line *Eae* to the left.

186. AREAS IV TO VII INCLUSIVE. TRANSFORMATION CURVES, *GHSE*, *PSP'*. — The underscored V curve *GHSE*, *PSP'* is closely comparable with the freezing-point curves of our complete-insolubility series of alloys, eutectiferous throughout their length, the type to which we assumed for simplicity that salt-water and the lead-tin alloys belong. But instead of representing true freezing-points, *i. e.*, a passage from the molten to the solid state, it represents transformations which take place within the solid but still red-hot and plastic steel. As we have seen composition *S*, about 0.90 per cent of carbon, is that of a definite eutectoid or quasi-eutectic (§ 148, p. 178), pearlite, composed of alternate

plates of ferrite or iron, and cementite or the definite iron-carbide, Fe_3C , in the ratio of about 6 parts of the former to one of the latter.

187. GENESIS OF THIS CONSTITUTION. — While this has indeed already been treated at some length, especially in §§ 145 to 149, 169 and 172, yet a second presentation of the matter in a different and more concise form may be acceptable to some readers. To this end let us follow the cooling of steels of three typical compositions, *viz.*, 0.90, 0.50 and 1.00 per cent of carbon respectively, *i. e.*, eutectoid, hypo-eutectoid and hyper-eutectoid steel, looking particularly at the manner in which the constitution found in the steel when cold comes into existence, or in short, the genesis of this constitution. In each case let us suppose that the cooling metal has previously been cooled from the molten state to 1150° , at which temperature we have already seen (§ 168, p. 198), that the metal is unsaturated austenite.

188. (1) EUTECTOID STEEL, 0.90 per cent carbon. Austenite of this composition, or eutectoid austenite, has received the special name of "hardenite." In cooling this undergoes no transformation until the temperature has fallen to S . On passing S the hardenite is transformed into the eutectoid pearlite already described.

The cooling curve is like that of any eutectic, Figs. 10 and 28 E, and the correspondence is as follows:

Fig. 28E

Fig. 68

AC	hS	The solid but red-hot hardenite cools.
CD	S	The hardenite is resolved into the eutectoid pearlite.
DE	Sh'	Pearlite cools.

189. (2) HYPO-EUTECTOID STEEL, 0.50 carbon. — In cooling from 1130° , h'' , the first transformation begins on reaching the line HS at h''' . As the temperature begins to descend from this point to the point h^{iv} on the line PS , the excess-metal, iron or ferrite, begins to separate out within the plastic mass in the form of distinct grains or imperfect crystals, and this separation of ferrite within the plastic mass continues from h''' to h^{iv} .

This separation is clearly parallel with the selective freezing of lead from a lead-tin alloy rich in lead, or of ice from a salt-water solution. It is a progressive separating out of the excess-substance, iron, and is therefore accompanied by a correspond-

ing enrichment in carbon of the residual plastic mother-metal, so that as the temperature falls the composition and temperature of the mother-metal at successive instants are represented by points in the line HS between h''' and S , or in other words, the temperature and composition of the plastic mother-metal slide from h''' to S . Consequently by the time the temperature has fallen to 690° or h^{iv} , the mother-metal has reached the eutectoid composition of hardenite, and simultaneously the eutectoid transformation temperature. On farther fall of temperature this hardenite splits up into alternate layers of ferrite and cementite, or in other words is resolved into pearlite.

The cooling curve is like that of an alloy of two metals reciprocally insoluble, such as lead and tin, Fig. 28 B, C, D and F , or like that of salt water, Figs. 8, 9 and 11.

The correspondence is as follows:

Figs. 28 B, C, D , etc. Fig. 68

AB	$h''h'''$	Hypo-eutectoid red-hot austenite cools.
BC	$h'''h^{iv}$	The excess-substance, ferrite, separates out, and the mother-metal is enriched in carbon till it becomes hardenite, <i>i. e.</i> , austenite of 0.9 per cent carbon.
CD	h^{iv}	Hardenite is resolved into pearlite.
DE	$h^{iv}h^v$	The conglomerate of pearlite plus ferrite cools.

190. (3) HYPER-EUTECTOID STEEL, 1 per cent carbon, $r'W$.
The cooling is undisturbed from $r' 1130^\circ$ until the temperature falls to L on line SE , but here the excess-substance, carbon, begins to form or separate out in the shape of crystallites of cementite permanently imprisoned within the plastic metal in which they are born. The cementite continues to form as the temperature falls from L to U on the line PSP' . This birth of cementite like the birth of ferrite in the last case, is parallel with the freezing out of the excess-metal from a molten alloy of the complete insolubility type, or of salt from salt water. The separating out from the initial austenite of the crystallites of cementite, which contain 6.67 per cent carbon, impoverishes the mother-metal in the excess-substance, carbon, and enriches it in the deficit-substance, iron, and this impoverishment in carbon continues as the temperature falls, so that, as it were, temperature and composition slide

along the line *LS*. Hence when the temperature has fallen to the eutectoid transformation-point, *S*, the composition of the mother-metal has reached this same point, or in other words, the austenite has been impoverished in carbon until it has reached the hardenite ratio 0.90 per cent carbon, 99.10 per cent iron.

With further cooling this hardenite as before splits up into pearlite, at approximately constant temperature, *S*, and once this transformation is complete the further cooling is without any further transformation that requires our present attention.

The cooling curve is like that of the hypo-eutectoid steel and therefore like that of any alloy of two metals of the complete insolubility type, Figs. 28 *B* to 28 *D*, etc. The correspondence is as follows:

Figs. 28*B* to 28*D*, etc. Fig. 68

<i>AB</i>	<i>rl</i>	Red-hot plastic hyper-eutectoid steel cools.
<i>BC</i>	<i>LU</i>	Cementite, the excess-substance, forms within the plastic mass impoverishing the mother-metal in carbon till it reaches the hardenite ratio, 0.90 carbon.
<i>CD</i>	<i>U</i>	The hardenite mother-metal splits up into pearlite at approximately constant temperature.
<i>DE</i>	<i>UW</i>	The conglomerate of pearlite plus cementite further cools.

Transformations parallel with those in solid iron appear to occur in some alloys when solid, for instance those of copper and tin,* and those of copper with antimony, Fig. 51, p. 150.

191. DIFFERENT ALLOTROPIC STATES. — A complication is introduced by the fact that the iron of the austenite of region IV is in an allotropic condition different from that of the iron which is liberated as ferrite as the metal cools from region IV into regions V and VI. In region IV the iron in the austenite is in the allotropic state known as *gamma* (γ) iron; but the iron liberated as ferrite by the transformation in passing from region IV into that part of region V which lies above the line *MH*, is in the *beta* (β) state. Moreover when the temperature falls past the line *MH* this *beta* iron again changes to *alpha* (α) iron.

* Wm. Campbell, "Microscopical Examination of the Alloys of Copper and Tin," *Proc. Inst. Mechanical Engineers*, Dec. 20, 1901.

192. SPECIAL NOMENCLATURE OF THE TRANSFORMATION CURVES, *GHSE, PSP'*. — In order to indicate with precision the nature of the changes which correspond to each of the steel transformation curves, and further to indicate clearly the correspondence between the transformations during cooling and those during rise of temperature, Osmond instituted a special set of names, now in general use, based upon Tschernoff's original nomenclature.

The temperature at which *gamma* iron changes to *beta* (which is the temperature at which free iron or ferrite begins to separate out of the austenite, *e. g.*, *K'* in the case of the 0.20 per cent carbon steel), is known as Ar_3 ; that at which *beta* changes to *alpha* is known as Ar_2 ; that finally at which the residual mother-austenite which has remained undecomposed during the fall from *K'* to *K'''* and at *K'''* changes into pearlite, is known as Ar_1 .

Between *H* and *S*, Ar_3 and Ar_2 occur together, as do Ar_2 and Ar_1 between *S* and *P'*, and Ar_3 , Ar_2 , and Ar_1 at *S* itself; so that these critical points in these special cases are called Ar_{3-2} , Ar_{2-1} , and Ar_{3-2-1} respectively. The corresponding critical points which occur during rise of temperature, with the reverse transformations, are called Ac_1 , Ac_2 , Ac_3 , *etc.* Here *A* (Tschernoff) is their generic name, *r* refers to falling temperature (*refroidissant*), and *c* to rising temperature (*chauffant*).

When A_1 is spoken of without indicating whether Ar_1 or Ac_1 is referred to, it should be understood that this transformation is looked at in a general way, both the Ac_1 transformation in heating and the Ar_1 transformation in cooling being in mind.

As to the shifting of the temperature of these transformation curves see the last part of § 164, p. 196.

193. PROPERTIES OF THE ALLOTROPIC STATES. — As to the properties of these three allotropic states of iron a word may not be out of place.

Alpha iron is iron in the state in which we habitually know it in the softest and most ductile varieties of steel and wrought iron, a relatively weak, ductile metal strongly magnetic. This is the variety stable at all temperatures below Ar_2 and is characteristic of wrought iron and slowly cooled low-carbon steel. In other words, the molecules of iron which constitute the ferrite of wrought iron and low-carbon steel are apparently in the *alpha* state, a fact which harmonizes with the softness and ductility of these varieties of iron. Doubtless this softness is to be referred

in chief part to the fact that these varieties are composed chiefly of the soft ferrite and in only small part of the glass-hard cementite; but the ductility and softness are probably exaggerated by the fact that this ferrite is in the *alpha* state, instead of being in the *beta* or *gamma* state. There is important evidence in support of this view.

Beta iron is non-magnetic (in the usual sense of being very feebly magnetic), is stable between Ar_2 and Ar_3 , is probably very hard and brittle, and is probably characteristic of certain self-hardening steels, such as manganese steel containing 7 per cent of manganese, and perhaps also of normal or carbon steel when hardened by sudden cooling from a red heat.

Gamma iron also is non-magnetic, and it is stable at temperatures above Ar_3 . It is probably characteristic of nickel and high-manganese steels (say of 12 to 14 per cent of manganese), and is probably relatively hard yet ductile.

That iron becomes stronger, harder, and less ductile as its carbon-content increases, must be in very great part referred to the mechanical influence of the cementite, Fe_3C , which that carbon forms, in the ratio of 15 parts of cementite to each part of carbon; but it also may be due to the brake action of this carbon, inducing part of the free iron or ferrite to remain, during its cooling from the high temperature at which it is cast or forged, in one of its harder and stronger allotropic states, *beta* or *gamma*.

194. TRANSFORMATION PARALLEL WITH FREEZING. — To recapitulate, our transformation phenomena in steel in its critical range are closely parallel with those that occur in the freezing of a lead-tin alloy, or a salt-water solution. Thus, our slowly cooled steel will consist of pearlite plus an excess of cementite or of ferrite according to whether carbon is present in excess above the pearlite ratio 0.90 per cent, or is below that ratio. The V-shaped transformation curves, the horizontal transformation line PSP' which underscores them, the separation of an excess-substance beginning at the V-shaped curves, the corresponding progressive change of the mother-metal in composition until at the transformation line PSP' it reaches the hardenite ratio, the ensuing transformation of the hardenite into interstratified plates of its components in the form of pearlite, the fact that the pearlite is of constant composition, independent of the initial composition, and that its composition is not in simple atomic ratio; the occurrence

of surfusion giving rise to the recalescence; all these facts are exactly parallel with what occurs in the freezing of a eutectiferous alloy. Pearlite, the eutectoid, differs from a true eutectic only in being generated by a transformation within a plastic solid, instead of by the solidification of a fluid. Hardenite is the untransformed, pearlite the transformed and split eutectoid.

CHAPTER IX. — THE HEAT-TREATMENT OF STEEL AND CAST IRON

195. THE HEAT-TREATMENT OF STEEL AND CAST IRON. IN GENERAL. — The properties of steel and cast iron can be modified profoundly by thermal treatment. The two chief principles involved are the control of the lagging reactions, especially (4), (9) and (10), and the control of the structure.

By the control of the lagging reactions, I mean causing them to occur to a predetermined degree, so as to control the proximate constitution of the alloy, for instance so as to give it exactly the desired proportion of austenite on one hand, and of ferrite and cementite on the other. We control these reactions either by restricting them by proper rapidity of cooling when they naturally tend to occur spontaneously in the cooling of the metal from the high temperature at which it is made, cast, forged, or rolled; or by stimulating them so as to cause them to occur to a greater degree than would be natural under normal conditions of cooling. The reactions upon which we play are probably chiefly the following:

(4) molten solution = 2 per cent austenite + graphite (§§ 166 and 167, pp. 197 and 198);

(9) austenite = ferrite + cementite (§ 169, p. 199), and

(10) graphite + austenite = cementite (§ 172, p. 200).

Reaction (9) is characteristic of both steel and cast iron; reactions (4) and (10) are characteristic of cast iron only.

While all three of these reactions are subject to lag, *i. e.*, while they all take an appreciable length of time, reaction (9) is very much more rapid than either of the others. It appears to take usually at most but a few minutes, whereas reactions (4) and (10) are much slower. Reaction (4) indeed, for reasons already

In this figure ordinates represent temperature, while abscissæ represent, not time from the beginning of the observation, but the interval of time occupied in cooling through a given number of degrees Centigrade. Point *B* represents the upper limit of region VIII, *i. e.*, *Ar_s*. The part *DE* is not given in the original, but is sketched in here by eye.

This phenomenon is by no means an isolated one. Person reported in 1847 a like recalescence by d'Arcet's alloy, which solidi-

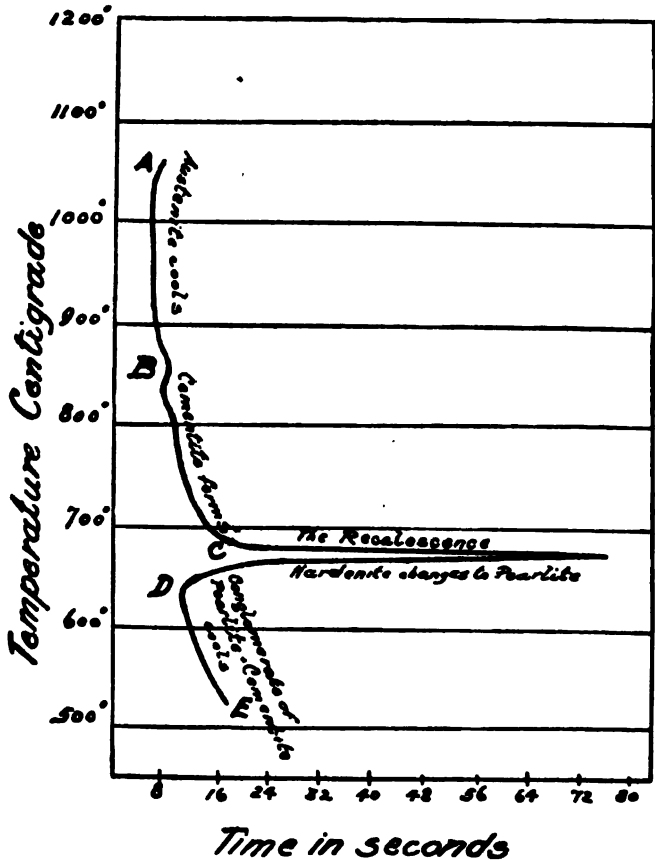

Fig. 69. Retardations in the Undisturbed Cooling of Hard Steel of 1.25 per cent Carbon.

(F. Osmond, "Transformations du Fer et du Carbone dans les Fers, les Aciers et les Fontes Blanches," Paris, 1888, pl. 2.)

fies at 96° , then cools regularly to 57° and then suddenly recalesces one or two degrees.*

This actual rise of temperature through the rapid evolution of heat due to the rapidity of the transformation once it sets in well, reminds us of the bumping of solutions. They rise very slightly above their proper boiling-point, boiling begins, and because this temperature is above the true boiling-point the boiling is violent, or bumping.

198. THE HARDENING AND TEMPERING OF STEEL.—The foregoing puts us in a position to understand the more prominent features of the heat-treatment of steel, such as hardening, tempering, *i. e.*, mitigating the hardening, and annealing.

To recapitulate, if steel is cooled suddenly from above the critical range A_1 to A_3 , it is thereby made harder and less ductile or even extremely brittle, and is said to be "*hardened.*" The degree to which it is thus hardened increases with the carbon-content, so that, whereas very low-carbon steel is affected only very slightly, steel with 1.00 per cent of carbon is made as hard and nearly as brittle as glass.

The hardness and brittleness induced increase with the rapidity of cooling without limit, but they are apparently nearly independent of the temperature from which the sudden cooling begins, provided that this is distinctly in regions IV or VII of Fig. 68, *i. e.*, provided that the quenching temperature is above the transformation range, regions V and VIII of Fig. 68. As, in a series of pieces quenched from different temperatures, the quenching temperature progressively rises from specimen to specimen through the transformation range, so do the resultant hardness and the brittleness of the quenched steel. In short, the hardening power is acquired in rising through the transformation range, and is lost progressively in slow cooling through that range.

The tensile strength at first increases with the intensity of hardening, but reaches a maximum and then declines. In case of high-carbon steel a moderate rapidity of cooling may give the highest tensile strength; but in case of low-carbon steel the tensile strength seems to increase with rapidity of cooling without limit.

* *Comptes Rendus*, XXV, p. 444, 1847.

Hardened steel is "*tempered*," *i. e.*, the hardening is mitigated or let down, by slight reheating, say to 200° or 300°; and the steel is "*annealed*," *i. e.*, the hardening is completely removed, by reheating farther, say to 600°. After this reheating to 200° or 300° it is immaterial whether the steel is then cooled suddenly or slowly; the degree of tempering is the same in either case; and the same is substantially true of the higher heating to 600°, or *annealing*.

The reason why this sudden cooling from above the critical range thus hardens and embrittles steel is, as is now generally admitted, that the rapid cooling denies the time needed for the completion of the change from the condition of austenite into that of ferrite and cementite, with the consequence that the suddenly cooled steel actually consists of austenite, which is much harder and more brittle than the mixture of ferrite and cementite into which the steel tends to change at all temperatures below the critical range.

The tendency to change appears to increase as the temperature passes farther and farther from the normal transformation temperature; but as the temperature descends, a resistance to this change arises, a resistance which grows more rapidly than the tendency to change; so that by the time the metal has reached the room-temperature, the change, which is still tending to occur, is prevented by this resistance which we may assume provisionally is frictional in its nature. In hardened steel the molecules are locked in the abnormal condition of austenite by what we may call the frictional resistance of the cold. This will be farther elucidated in § 201, p. 225.

The pearlite, either alone or with the excess of ferrite or cementite, into which austenite is resolved in slow cooling, is much softer and more ductile than austenite, in spite of the fact that cementite itself is harder than austenite. But this cementite is accompanied by a quantity of ferrite so great as to outweigh greatly its influence. Thus, slowly cooled steel containing 1.00 per cent of carbon would have only 15 per cent of cementite, mixed with 85 per cent of ferrite. The bearing of this is of course uninfluenced by the fact that the 85 per cent of ferrite together with 13 out of the 15 per cent of cementite, are interstratified as pearlite, so that the steel consists of $85 + 13 = 98$ per cent of pearlite plus 2 per cent of free cementite, *i. e.*, cementite in excess

of the eutectic ratio, and hence structurally free from that pearlite.*

The higher the carbon-content of the steel as a whole, (1) the higher is the carbon-content of the austenite which is preserved by sudden cooling, and (2) the harder is the suddenly cooled steel. Fact (2) may be referred to fact (1), or to the apparent brake action of the carbon which retards the transformation from the hard, *beta* or *gamma* brittle iron to the soft, ductile *alpha* iron; or better to both causes jointly.

The much greater hardness of austenite than of the mixture of ferrite and cementite into which it is resolved in slow cooling, suffices to explain readily the hardness and brittleness which its retention by sudden cooling causes, and there is general agreement that this is the cause of the hardening, though as to the constitution of austenite it appears that some have not yet been convinced.

199. THE HARDENING INCREASES AS THE QUENCHING TEMPERATURE RISES THROUGH THE CRITICAL RANGE, BUT IT IS INDEPENDENT OF THE TEMPERATURE ABOVE THAT RANGE.—The following table shows how the tensile strength and hardness of

* Should it appear strange that hardened steel is actually very much harder, indeed incomparably harder, than the same steel when annealed, in spite of the fact that the cementite present in the latter is actually harder than the austenite of which the former consists, a simile may explain the apparent anomaly.

To fix our ideas let us consider the case of eutectoid steel, which when annealed consists of about 6 parts by weight of ferrite to each part of cementite. Compare with the steel in its hardened and its annealed states respectively (1) bronze, and (2) a mechanical mixture of finely-ground dust of glass in impalpable powder with six times its volume of lead. (Those unfamiliar with the properties of bronze and lead may substitute putty for lead in this comparison.)

Such a mixture of glass dust with an overwhelming excess of lead, while doubtless stiffer and harder than the lead alone, must clearly be incomparably softer than a like mass of solid bronze, although the glass itself is much harder than that bronze. Quite so the mixture of which our annealed steel consists, of one part of hard cementite in impalpably fine grains with an overwhelming excess of soft copper-like ferrite, is naturally softer as a whole than a mass of austenite of which hardened steel consists, although the cementite in the annealed steel is itself harder than that austenite. The thing to look at is the great excess of the soft ferrite in which the microscopic particles of cementite in annealed steel are drowned.

TABLE 9. — Influence of Quenching Temperature on the Physical Properties, Carbon Condition, and Micro-structure of Steel of 0.21 per cent of Carbon. (Howe and Sauveur.*)

No.	Quenching Temperature, Degrees C.		Tensile, Pounds per Square Inch	Hardness, Width of Scratch, mm.	Elongation		Contraction per Cent of Area	Missing Carbon, per Cent	Micro-structural Composition, per Cent		
					Per Cent	Inches			Marten-site	Pearlite	Free Ferrite
6	880	Above Ar ₃	224,600	—	3.50	2.5	—	Average 0.094	100	}	0
7	836		207,500	0.0276	3.00	4	5		0.095		
4	797		218,200	0.0285	6.00	4	—		0.102		
16	761		193,516	—	1.25	4	1.01		0.082		
15	733		220,868	0.0290	4.50	4	—		0.095		
12	714	Beginning of Ar ₃	221,300	0.0281	7.50	4	—	0.102	97.20	}	2.80
18	713		211,316	0.0303	2.50	4	1.54	0.093	86.00		14.00
9	698	Middle of Ar ₃	206,673	0.0293	3.75	4	3.53	0.096	70.20	}	29.80
5	652	Between Ar ₃ and Ar ₁	145,000	—	2.25	4	3.17	0.100	35.20		64.80
14	650		142,000	0.0298	4.75	4	5.68	0.084	30.80		69.20
21	633		128,237	0.0333	4.25	4	5.87	0.084	32.00		68.00
10	626		125,756	0.0320	5.50	4	5.94	0.084	31.50		68.50
22	620		Beginning of Ar ₁	121,058	0.0329	6.25	4	5.60	0.091	30.02	1.60
11	600	End of Ar ₁	91,600	0.0333	13.50	4	44.40	0.034	4.00	17.50	78.50
3	599		89,000	0.0332	13.00	4	46.50	0.047	2.00	22.20	75.80
8	575	Below Ar ₁	93,400	0.0343	19.75	4	38.60	0.029	}	21.10	78.90
19	532		82,771	0.0343	21.25	4	51.34	0.005		23.20	76.80
13	512		82,100	0.0350	26.00	4	54.40	0.018		23.00	77.00
17	340		79,362	—	23.75	4	53.54	0.000		22.60	77.40
20	263		76,523	—	22.50	4	55.64	0.000		24.80	75.20
23	20	73,956	0.0305	22.75	4	52.29	0.008	23.60	76.40		
24	Not treated at all	93,707	—	18.75	4	53.89	—	—	—	—	
25		94,340	0.0331	17.50	4	51.14	—	—	—	—	
Total loss or gain			150,644	0.0086	22.75	—	—	0.102	—	—	—

steel of 0.21 per cent carbon increase as the quenching temperature rises through the critical range (600° to 714°), how the ductility correspondingly diminishes, and how the pearlite and ferrite are progressively replaced by austenite (variety martensite). The table further shows when once the quenching temperature has risen above the transformation range (733°), further rise of the quenching temperature is without material influence on the properties of the hardened steel.

200. THE HARDENING INCREASES WITH THE RAPIDITY OF COOLING WITHOUT LIMIT. — The following table illustrates this fact:

TABLE 10. — *Influence of the Rapidity of Quenching on the Properties of Steel of 0.21 per cent of Carbon. (The Author.)**

(The steel experimented on is the same which is represented in Table 9)

COOLED IN	TENSILE STRENGTH lbs. per sq. in.	ELASTIC LIMIT lbs. per sq. in.	ELONGATION per cent in 2 inches	CONTRACTION OF AREA per cent
Iced Brine	237,555	237,170	2.0	1.30
Cold water	216,215	—	1.5	1.67
Oil	174,180	—	2.9	1.403
Air	86,797	54,342	27.76	57.829
In furnace	80,103	44,221	28.15	54.749

Here the tensile strength was increased about three-fold while the ductility, originally very great, was nearly completely destroyed by the most rapid of the coolings employed.

Further, as the rapidity of cooling increases from case to case, so does the tensile strength increase continuously and the ductility decrease but more suddenly.

201. LIKE PHENOMENA IN ALLOTROPIC CHANGES. — We saw in §§ 194 and 197, pp. 216 and 219, that the phenomena of the recalcence of steel, the surfusion and reheating, are closely like those of both aqueous solutions and molten metals and alloys in freezing. It is instructive to note both sets of phenomena are like those of the allotropic changes of state in solids. Thus in case of sulphur the prismatic state is the normal and stable one at temperatures between 95.6° and its melting-point, but the octahedral

* Unpublished data.

state is the normal one below this temperature. (See Fig. 70.) When octahedral sulphur is heated above 95.6° it changes to prismatic, not instantaneously, yet the faster the higher the temperature is raised, so that the faster the rate of heating is, the higher will be the temperature at which occurs the crest of the change, if we may so speak, that is to say, the most rapid part of it. Conversely, when prismatic sulphur is cooled from above 95.6° it changes into the octahedral variety with a rapidity which at first increases as the temperature descends farther and farther below 95.6° , reaches a maximum rate of transformation at about 60° , and then is slackened, so that prismatic sulphur, by rapid cooling to -30° can be preserved without an appreciable degree of transformation, and remains unchanged at that temperature indefinitely.*

The conditions of these transformations are somewhat as follows. On cooling to the normal transformation temperature, the substance tends to change its state; this impulse is opposed by what may be likened to molecular inertia, static-frictional resistance, or, as it were, unwillingness of the atoms to shift from their initial molecular arrangement into that which has now become normal. As the substance cools farther and farther below the normal transformation-point, the impulse to change is increased, so that, as it were, the actual tendency to change, the transformation-moment, is the product of the normal impulse at 95.6° to change, multiplied by the lever-arm of the temperature-interval, *i. e.*, the number of degrees that the existing temperature is below 95.6° , or multiplied by some function of that lever-arm. This, at least, will serve as a simile, without pretence to rigorous accuracy.

On the other hand, the lower the temperature the greater is the molecular rigidity, the molecular inertia, the frictional resistance to molecular transformation. Hence the net effect, or the rapidity of change, at first increases as the temperature sinks below 95.6° , the normal transformation-point; then, as the increasing molecular rigidity offsets the increasing temperature lever-arm, the rapidity ceases to increase, *i. e.*, reaches a maximum;

* These assertions as to sulphur are based on Le Chatelier, *Revue Gen. des Sciences*, 1897, p. 13, where may be found a very lucid discussion of the theories of the hardening of steel. Older determinations gave 100° to 114° or 105° to 115° as the range in which the prismatic state of sulphur is the normal one.

then it decreases, until in case of sulphur it becomes zero at -30° , and in the case of steel, at or above the room-temperature.

When, however, octahedral sulphur is heated above the transformation-point 95.6° every increase of temperature both increases the temperature lever-arm and lessens the molecular rigidity, so that the transformation-moment increases with the temperature without limit (except of course that it vanishes at the melting-point).

Fig. 70 is an attempt to represent this state of affairs.

Column 1 indicates the strength of the impulse to change, increasing with the lever-arm of the temperature-distance from 95.6° ; column 2 indicates the strength of the resistance corre-

	1	2	3
	<i>Impulse to Transform</i>	<i>Molecular Resistance to Transformation</i>	<i>Resultant Speed of Transformation</i>
95.6°	<i>Slight</i>	<i>Slight</i>	<i>Moderate</i>
0°	<i>Greater</i>	<i>Greater</i>	<i>Maximum</i>
-30°	<i>Greater</i>	<i>Greater</i>	<i>Great</i>
-100°	<i>Greater</i>	<i>Greater</i>	<i>Complete Arrest</i>

Fig. 70. The Transformations of Sulphur.

sponding to the existing temperature; and column 3 the rapidity with which the transformation actually occurs, a rapidity determined by the ratio between impulse and resistance.

These phenomena are closely reproduced in the hardening and recalcence of steel. (1) The faster the cooling, the lower is the temperature at which the recalcence occurs. (2) A sufficiently rapid cooling suppresses this transformation almost completely or at least to a very great degree. (3) Steel in which it has thus been suppressed remains indefinitely at the room-temperature without undergoing this transformation appreciably if at all, *i. e.*, the suppression is permanent. (4) The transformation in rising temperature, *i. e.*, from pearlite to austenite, takes place

at a much higher temperature than the recalescence or transformation in cooling as already pointed out, the difference being usually from 30° to 40° , but depending greatly upon the rate of cooling. (5) The conception that molecular friction or rigidity increases as the temperature descends is in harmony with the fact that while the transformation in cooling usually occurs so far below the normal transformation temperature that, once it has set in, its longer temperature lever-arm causes it to be so rapid that the heat evolved may raise the temperature by some 10° *, yet the reverse transformation in rising temperature, which of course must be accompanied by an equal absorption of heat, occurs so much nearer the normal transformation temperature that the actual refrigerating effect (if one may so speak of a cooling of a few degrees at a red heat) is relatively slight, and indeed is very often replaced by a simple retardation of the rise of temperature.*

202. SIMILE TO THE STRUGGLE BETWEEN TRANSFORMATION AND RESISTANCE. — In the sudden cooling of steel or sulphur we recognize two opposing forces, the tendency of the overdue transformation to accomplish itself, and opposed to it the frictional resistance or rigidity of the cold. The former tendency increases with the lever-arm of the temperature distance below the true transformation-point; the latter increases with the cold, and finally masters the former.

The simile which I now offer may help to fix this conception in the mind, though I do not think that it really throws any light on the nature of what we have called "frictional resistance."

I am asleep on the ground, exhausted. Someone wakes me; I see fifty yards away the warm camp-fire. I am not quite warm enough; I should like to go to the fire, but is it worth while? Only after a struggle do I rise and move to the fire.

Next evening some one wakes me under like conditions; this time I am uncomfortably cold; I arise, though reluctantly, and walk to the fire.

The next time I am shivering with the cold, and some one has just thrown ice-water over me; I am cold and wet; I run to the fire.

The next time some one half wakes me by shaking; I am be-

* Osmond, "Contribution à l'Étude des Alliages," p. 376, 1901; *The Metallgraphist*, IV, p. 158, 1901; the author, *Trans. Am. Inst. Mining Engineers*, XXIII, pp. 484 to 488, 1893.

numbed with the cold; in my sub-consciousness I am faintly aware of a terrible need of warmth; if I do not go to the fire I die; but I am so benumbed and stupified that I cannot rouse myself; I sink back.

In each case we have the motive, the desire for needed warmth which prompts me to arise and go to the fire; in each case we have the resistance of inertia, which in the last case is so greatly exaggerated by the cold as to master completely the motive to act.

203. EVIDENCE SUPPORTING THIS THEORY. — That the preservation of the austenite is the cause of hardening is shown in a variety of ways, for instance by the data in §§ 199 and 200, and also by other experiments of the author which will now be outlined. If steel of 1.10 per cent of carbon is heated carefully to 700° and then suddenly cooled in water, it does not become hardened. If, on the other hand, the steel is heated to a temperature considerably higher, say 880°, then cooled to 700° slowly, and then quenched in water from 700°, it is hardened. The explanation is very simple: in the former case the transformation from ferrite and cementite to austenite has not yet occurred: the steel at the moment of quenching is still ferrite plus cementite. In the latter case, although the quenching temperature is the same as in the former, and is in all probability several degrees below the normal transformation temperature, yet, because of lag, the transformation [reaction (9)] has not yet taken place, *i. e.*, the austenite has not been transformed into ferrite and cementite, but is present to be preserved by sudden cooling, which thus hardens the steel. And in general the author found that the steel was hardened if it was quenched before the recalcence occurred, no matter from what temperature it was quenched. On the other hand it was not hardened if quenched even from higher temperatures, provided the reverse change from pearlite into austenite had not taken place,* so that the metal was not in the condition of austenite.

It is only by thus preserving our austenite by sudden cooling, that we are able to examine it in the cold. And this preservation

* *Trans. Am. Inst. of Min. Eng.*, XXIII, 1893, pp. 498 to 520.

Osmond had previously obtained strong indications that the loss of the hardening power coincided with the recalcence ("Transformations du Fer et du Carbone," pp. 38 and 87, 1888).

is never complete. In spite of the suddenness of the cooling the austenite so far transforms towards the condition of ferrite and cementite as to reach at least the decomposition-stage called martensite. Instead of remaining pure unmagnetizable austenite, enough magnetizable ferrite and cementite arise to make the mass as a whole highly and permanently magnetizable.

To sum up: the hardening of steel is due to the preservation of the austenite condition by cooling the metal so suddenly that we deny the time necessary for the change from austenite into pearlite, etc. We say that, once the metal has been completely cooled, this change can no longer occur, because the molecules are locked in the unstable condition of austenite by the rigidity which this low temperature causes.

204. THE TEMPERING OF HARDENED STEEL by slightly reheating it say to between 220° and 320° (temperatures which we recognize by the pale yellow and dark blue coatings of oxide which form on the surface of the metal, Fig. 68), appears to act by slightly lessening this molecular rigidity, giving such freedom of molecular change that a little of the unstable austenite retained by the sudden cooling may follow its natural impulse to change into pearlite, etc.; *i. e.*, to follow the course which it would have taken on cooling, through the transformation range (region V or VIII), had its passage been sufficiently slow to permit these changes to occur.

The higher this reheating is carried the more does it relax this molecular rigidity, this frictional resistance to the change from the existing abnormal condition of austenite to the normal condition of ferrite and cementite. Hence it is that, while reheating even to 66° effects a very slight tempering, reheating to say 230° (at which temperature the iron oxide which forms on any brightened face of the metal is of a straw color), effects a much greater tempering, so that the metal thus tempered is far less brittle than it was when initially hardened by sudden cooling. Hence, too, it is that reheating to say 300° (at which temperature the oxide on any brightened face assumes a permanent blue color), effects a still greater tempering, so that the hardness and brittleness resulting from the initial sudden cooling are removed to a much greater extent still.

Steel tempered at 230° is suited for use in the form of instruments like razors, lancets, etc., for these require great hardness,

so that they may cut sharply; while a marked degree of brittleness can be tolerated in them, because they are not exposed to shock. On the other hand, if a rock drill or a cold chisel was tempered only at 230° , it would be too brittle to endure the violent shocks to which these tools are exposed. Therefore we have to temper them farther, by reheating them to say 300° ; so as farther to remove their brittleness. In doing so we indeed lessen their hardness and cutting power; but this is the less of two evils. We have to endure this loss of hardness, which while regrettable is tolerable, in order to reduce the brittleness to a degree which can be tolerated.

205. THE ANNEALING OF HARDENED STEEL, by heating it to a low red heat and cooling it thence slowly, allows the change from austenite to pearlite, *etc.*, to perfect itself.

Moreover, since the red-hot metal is no longer rigid but very plastic, mere reheating to redness relieves the stress (§ 209, p. 236), which had been induced by the differences in the rates at which different layers had cooled in hardening the steel, thanks to the suddenness of that cooling. The now red-hot plastic metal flows under stress, which thus effaces itself. The slow cooling from this reheating, and the greater evenness of the contraction thus induced among the different layers, simply prevents the introduction of new stresses. Beyond this, if the temperature of the annealing is raised above A_1 , the recombination of the layers of ferrite and cementite of the pearlite to reconstitute austenite, and the molecular migration which accompanies this, minute as are the distances traversed, appear to break up any coarseness of structure and to remove the brittleness to which that coarseness leads.

one breath

206. A SIMILE TO EXPLAIN TEMPERING AND ANNEALING. — In § 202 we considered a simile the object of which was to give a clearer mental picture of the struggle between the tendency of the suddenly cooled steel to transform itself from the state of austenite into that of ferrite and cementite, and what we called the frictional resistance offered by the cold; or in other words a mental picture of the condition which exists both during the sudden cooling of steel, and in the suddenly cooled or hardened steel.

With these same general ideas of tendency to transform and the frictional resistance to transformation before us, let us consider another simile, offered with the purpose of explaining the

phenomena of tempering as distinguished from those of hardening. To recapitulate, in hardened steel the molecules are locked in the condition of austenite which is abnormal below the transformation range, and they are prevented from following their natural tendency to change back into ferrite and cementite by frictional resistance.

This condition of affairs we may liken to that of a bent bow, held bent by friction. Let us suppose that the friction is applied

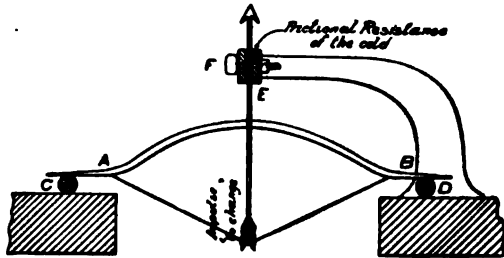

Fig. 71.

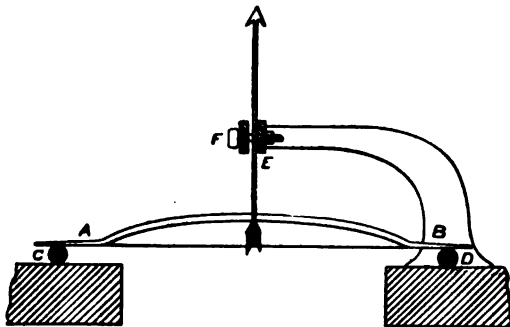

Fig. 72.

Figs 71 and 72. A Similie to Explain the Phenomena of Tempering Hardened Steel.

to an arrow which holds the bow bent, as shown in Fig. 71. The analogy would indeed be closer if we supposed that the friction was applied to the bow directly, instead of by means of the arrow; this, however, would be harder to illustrate to the eye.

The ends of the bow are prolonged as at A and B, and these prolongations are supported by the rolling cylinders C and D, on which the bow is free to slide. The arrow is held by the friction-

clutch *E*. If the bow was wholly free, it would straighten itself so as to reach the shape shown in Fig. 72; this is its straightening tendency; this tendency is resisted by the friction offered by *E*.

Now in our suddenly cooled steel the tendency to change from austenite into ferrite and cementite may be likened to this straightening tendency of the bow; and ~~the molecular resistance which prevents this change may be likened to the friction offered by the friction-clutch *E*.~~

If, by giving the set-screw *F* a slight turn, we slightly lessen the friction of *E*, the bow begins to straighten itself, and the arrow slips a little way through *E*. But in doing this, the tension on the bow itself, its tendency to straighten, weakens. Following Hooke's law, "*ut tensio sic vis*," the more fully the bow straightens itself, the less is the residual tendency towards further straightening; and so this tendency very soon falls to a point at which it is again balanced by the residual friction of *E*, and the bow ceases to straighten. Relax *E* a little more, and the bow again begins to straighten itself, and again this straightening ceases as soon as the tension remaining in the bow becomes so small that it is again equalled and mastered by the present friction of *E*.

We have much the same condition of affairs in our hardened steel. Reheat it to say 66°, and we thereby very slightly relax the resistance which the low temperature offers to the change of austenite into ferrite and cementite (reaction (9)), and because this resistance is lessened, this reaction immediately begins to set in. But as it progresses, and the quantity of austenite remaining grows less, so the tendency of that austenite to change back to ferrite and cementite decreases. The less austenite there is, the less is the tendency of that austenite to change into ferrite and cementite, the more easily is it held in check by the frictional resistance of the low temperature. If we reheat it beyond 66°, say to 200°, we relax farther the frictional resistance of the low temperature, and more of the austenite changes into ferrite and cementite; but this change is again arrested as soon as the quantity of austenite remaining is so small that the tendency which it exerts to change further into ferrite and cementite is again just balanced by the diminished frictional resistance represented by the temperature 200°.

Reheat it farther to 600°, and the frictional resistance to further change becomes so slight as to be insignificant; apparently

the whole of the remaining austenite changes into ferrite and cementite; reaction (9), which ought to have occurred on cooling past the critical range but was there prevented because insufficient time was given to effect it, now completes itself, and the hardened steel reaches the condition which it would have reached had the cooling been slow instead of sudden; the steel is *annealed*.

207. WHY THE RATE OF COOLING AFTER TEMPERING IS IMMATERIAL. — When we wish to harden a piece of steel, the cooling from above the critical range must needs be rapid, to restrain the tendency which arises as soon as the temperature falls below Ar_1 , to change from austenite to ferrite and cementite; hardening consists then in preventing or greatly restricting this change. But when we reheat a hardened piece say to 200° , and thereby allow this same suppressed change to take place to as great a degree as corresponds to the diminished frictional resistance of 200° , there is no motive, save that of convenience, for cooling suddenly. At 200° the change takes place with extreme rapidity to the degree which this temperature permits; hold the steel at 200° for an hour, and the change will not go materially farther than in the first few seconds. As soon as we begin to cool it again, as soon as the temperature begins to fall below 200° , the frictional resistance begins increasing, and now certainly no farther change can take place. If the friction at 200° sufficed to arrest farther change, surely the greater resistance at 199° will not permit any farther change. So no change will take place during this cooling, whether it is fast or slow; and hence it is immaterial whether the cooling is sudden or gradual.

Somewhat the same is true of the cooling after annealing, provided always that the temperature reached in annealing does not rise into the transformation range (regions V and VIII), because at least part of the ferrite and cementite, the condition which the metal would assume during the rise of temperature from the cold to say 500° or 600° , would again change back into austenite if the temperature rose into the transformation range above Ac_1 . If the reheating does not reach the transformation range, then the rate of cooling is relatively unimportant, save that rapid cooling from a temperature so high as 600° is likely to induce severe internal stress, because the cooling of the interior would lag behind that of the outside by so many degrees of temperature that the contraction consequent upon that cooling would

be markedly irregular in the different layers of the piece, a condition naturally resulting in internal stress.

The following diagram, Fig. 73, illustrates this principle, that while the rate of cooling from above (or indeed from within) the transformation range to the cold is of the greatest moment, the rate of cooling from any temperature below that range is relatively unimportant.

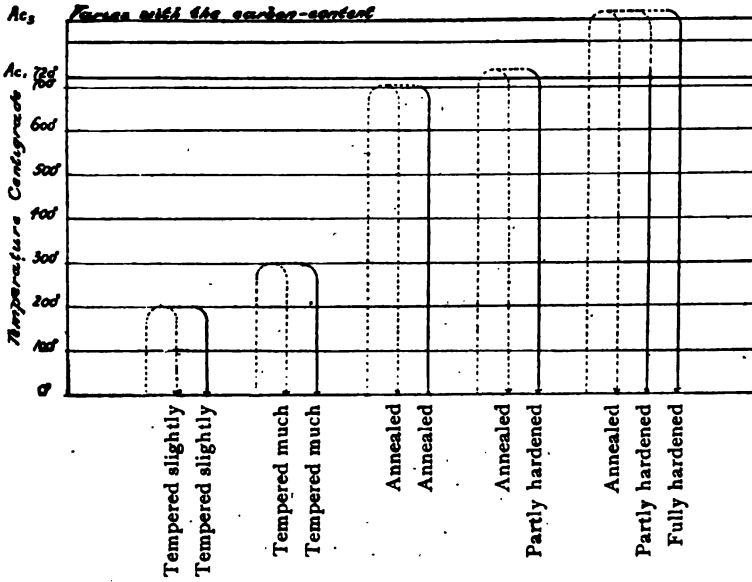

Fig. 73. The Rate of Cooling from below the Transformation Range is Immaterial, from above that Range is Decisive.

NOTE.—In each case the steel is supposed to have been hardened before undergoing the thermal treatment here indicated. Solid lines represent sudden changes of temperature, broken lines slow changes. The words below the several arrow heads indicate the final state of the metal after undergoing the temperature changes represented by the lines leading to the arrow head.

208. VERIFICATION OF THE LOSS OF THE HARDENING POWER AT THE RECALESCENCE. — The recalescence, and the recovery of the magnetic properties which accompanies it, as the iron changes from the allotropic, non-magnetic condition to the magnetic condition normal at the room-temperature, may be detected by means of a very simple experiment. To a wire $\frac{1}{16}$ inch in diameter,



of high-carbon steel, preferably eutectoid steel (0.90 per cent carbon), attach a fine wire of platinum or of manganese steel as a support. Neither copper nor common iron wire is suitable for a support, the former because it conducts the heat away so quickly, the latter because it is itself magnetic.

Heat the steel wire to a yellow heat in a Bunsen burner, and hold it near a magnetic needle which has no protecting glass case. At first the wire will not attract the needle, but as it cools down it suddenly becomes magnetic, and at the same time brightens perceptibly, *i. e.*, recalesces. This can best be seen in a dark room, but a practiced eye can detect it even in a light room.

By quenching a series of wires just above, during, and just after the recalescence, and then determining their ductility by trying to bend them, and their hardness by filing them, the student readily finds that the recovery of the magnetic properties on passing through the recalescence is accompanied by the loss of the hardening power; but that these transformations are spread out over a considerable range of temperature, so that the wire does not lose the last traces of its hardening power until it is cooled many degrees below the recalescence, *i. e.*, until perhaps fifteen seconds after it has begun to recover its magnetic properties.*

209. STRESS IN HARDENED STEEL. — Austenite itself is an extremely hard and a brittle substance; but the brittleness of hardened steel is doubtless due in some part to the residual stress which the sudden cooling induces. This stress is in turn due in large part to the fact that the cooling of the interior of a suddenly cooled object lags behind that of the exterior, so that during the latter part of the cooling, when the outer part is already cold and rigid, the interior has still to cool through a considerable range of temperature. Such residual cooling should cause corresponding contraction; but the effort of the interior to accomplish this contraction is resisted by the now rigid exterior, with which the interior is integrally united. Hence the exterior is left in a state of compressive, and the interior in a state of tensile stress, a state of affairs readily detected by sawing open a suddenly cooled piece of steel, say of 0.20 per cent of carbon. Before such a piece is sawn open the stresses are generally nearly symmetrical, so that they balance one another and do not greatly deform the piece as

* "Metallurgical Laboratory Notes," the author, Experiment 2, p. 10.

a whole. If, however, we saw the piece open we destroy this balance, and certain of the stresses, no longer counterbalanced, distort the object farther.

The stress in hardened steel is probably much intensified in another way which I will now explain. Even in sudden cooling, a considerable amount of transformation from austenite into ferrite and cementite evidently does occur, especially in the interior of the piece, which must cool much more slowly than its very skin. To whatever degree this transformation takes place, to that degree is the cooling and the consequent contraction of the layer in which transformation is occurring retarded. As the cooling of the interior must always lag behind that of the exterior, so it will happen that this retardation of the contraction of the interior must occur later than the corresponding though slighter retardation of the exterior. In other words, after the contraction of the exterior has undergone its slight retardation and is again proceeding at full speed, the contraction of the interior undergoes its greater retardation, thus tending to crack the exterior by resisting its tendency to contract.

210. SIMILE TO EXPLAIN INTERNAL STRESS. — Let an illustration make clear this conception of the state of stress which exists between the several layers of a suddenly cooled piece of steel or other substance. Suppose that through some disease both of my hands have swollen to double their natural size, though they retain substantially their normal shape. Suppose that while they are in this condition I put upon my right hand an iron glove which exactly fits it in its now swollen state, and that the hand and glove are firmly glued together by some efficient cement. Suppose that my health is now restored and that my left hand contracts back to its normal size. Evidently, my right hand at the same time will endeavor to contract in the same way to its normal size, but it will be prevented by the cement which glues it firmly to the incompressible iron glove. My hand will now be in a state of tension, endeavoring to reach its normal size, and through this endeavor it throws the glove into compressive stress. Here then we have a permanent state of stress between hand and glove. We have much the same condition of things between the different layers of a piece of suddenly cooled steel.

211. STRESS MAY WEAKEN OR STRENGTHEN. — Let us now consider another case, that of a guitar, the strings of which have

been tightened up in the usual way. In such a guitar the strings are evidently in a state of tensile stress endeavoring to contract, and their endeavor is resisted by the rigidity of the body of the guitar: hence this body is in compressive stress. The arrows in Fig. 74 indicate the direction of the stress in the strings and the body respectively. Many of us have learned by experience that, if we leave a tuned guitar over night at the sea-shore with-



Fig. 74. The Influence of Internal Stress upon Strength, *i.e.*, the Power to Resist External Stress.

out taking the precaution of slackening the strings, in the morning we may find these strings snapped. This means that the damp air has dampened the strings and so increased their desire or tendency to contract, and that this is resisted firmly by the body of the guitar. This endeavor to contract has resulted in tensile stress which has increased to such a degree that it has snapped the strings in two. Quite in the same way we often find that if we harden a piece of steel too violently, *i.e.*, if we cool it in water too suddenly, we induce stress so violent as to crack the skin of the piece quite as the excessive stress breaks the strings of the guitar.

Suppose now that while our guitar is in this state of stress indicated in Fig. 74, we hang it by means of the point *A*, and attach to one of the strings at *B* a weight, *W*, which is just the weight that the string would be able to sustain without breaking if it were not under tensile stress. The string will break. Clearly if my muscular strength is such that when I am unencumbered I can lift just 1000 pounds and no more, then if somebody places a load of 500 pounds on my shoulders I shall have strength sufficient to lift only an additional 500 pounds. I cannot eat my cake and keep it. If half of my strength is temporarily in use in sustaining a load on my shoulders, only the remaining half of my strength is available for lifting any additional weight. Exactly in the same way, inas-

much as the string of the guitar is under initial tensile stress, its power to resist an external load is correspondingly diminished.

Suppose next, that we hang a weight, W' , to the body of the guitar at the point C . As this body was initially under compressive stress, so it is capable of upholding a greater weight at W' than if it was not under this compressive stress.

Now looking at the guitar as a whole and considering its strength, *i. e.*, its power to resist loads applied to it from without, we see that the degree to which the existence of the internal stress affects this power to endure external loads depends upon how those loads are applied. If an external tensile stress is applied to the part of the guitar which is already under tensile stress; then the initial stress weakens the guitar. If, on the other hand, the tensile stress is applied to the body of the guitar which is initially under internal compressive stress, then that initial stress in effect strengthens the guitar. Thus we see that it may occur that internal stress may actually strengthen a piece taken as a whole, as regards its power to resist external stress applied in certain specific well-defined ways.

If now we load the tuned guitar as it were uniformly, *i. e.*, making the load W' just that which the body of the guitar would be able to sustain if free from initial stress, and W just that which the string would be able to sustain if also free from initial stress, then the fact that the string is initially under tensile stress will cause that string to break; this will throw the whole load, $W + W'$, upon the body of the guitar, and will thus break it in turn.

The useful strength of a steel object may be defined as the power of resisting external stress. When a steel object is to be used for a great variety of conditions not accurately defined beforehand, it is in general better that it should be well adapted to resist well every variety of probable systems of external stress rather than that it should have great power to resist a particular set of external stresses applied in some particular way, and very little power to resist another probable system of external stresses applied in some other probable way. In short for indiscriminate use what may colloquially be called "good all around strength" is what is needed. On this account the presence of internal stress in a steel object, while useful for certain cases, such as that of gun-jackets, in which the direction of the chief external stresses

to be endured in use is well understood, initial internal stress may be very valuable and may greatly strengthen the object for its one and only use; yet the existence of internal stress is in general undesirable in case of objects which in use are to be subjected to widely varying and indeterminate systems of important external stresses.

It was formerly thought that the hardening of steel was due to stress induced through sudden cooling; but while stress no doubt does exist and does contribute to brittleness in a material degree, yet it is perfectly clear that it is not the true cause of the hardening of steel. Two of the many reasons are quite sufficient to show this.

In the first place, if the hardening were due to stress then it should increase regularly with the temperature from which the sudden cooling occurs, or in short, with the quenching temperature. But in point of fact, far from this being the case, no true hardening takes place unless the quenching temperature is as high as the transformation range. And moreover, once this range is past, further elevation of the quenching temperature does not further increase the hardening. In other words, the hardening power is acquired in passing the critical range. In the case of eutectoid steel, that is to say steel of 0.90 per cent carbon, in which the critical range is extremely narrow, the whole of the hardening power is acquired in rising through this very narrow range of temperature.

The second reason is that if hardening were due to stress, then the other metals in general ought to be hardened by sudden cooling. But this is not the case. Manganese steel is made very ductile by sudden cooling, instead of being made brittle as carbon steel is. The fact that the hardening power is a special property which belongs chiefly to the iron-carbon compounds, and indeed is shared probably by very few other substances of any kind whatsoever, is in itself sufficient proof that the hardening is not the result of stress. Indeed, looking back now, it is astonishing that this stress explanation of hardening should have been put forth by such eminent writers for so long a period.

*The Heat-treatment of Steel, Processes Operating Chiefly
Through Control of the Structure*

212. IMPORTANCE TO THE ENGINEER. — This subject of the structure of steel, its relation to the properties of the metal and to the thermal and mechanical treatment which it has undergone, is probably of much more direct practical importance to the young engineer than any other subject considered in this work. Its importance may be made clearer by means of an example. May its patness atone for its homeliness.

You cannot make a bad beefsteak good by the cooking; you can cook it better or worse, and it will be a worse or a less bad beefsteak, but always bad. On the other hand you can easily spoil a good beefsteak by bad cooking. Now, just as cooking is to food so is heat-treatment to steel. Indeed, a pedantic cook might reasonably call cooking heat-treatment. Bad steel, steel of bad chemical composition, cannot be made good by heat-treatment; we can give it different degrees of badness, but we cannot cure that badness. On the other hand we can easily make good steel bad.

In one case as in the other the excellence or the defects of the treatment can in large part be recognized by simple external symptoms.

The cooking, its effects, and its symptoms are of immediate importance to the housewife, because they are under her control through her employees. In exactly the same way and for pretty much the same reasons heat-treatment, and its symptoms, the structure of the metal, are of great importance to the practicing engineer, not only because it influences the properties of his metal very greatly, but especially because the heat-treatment itself is often given by his own employees, his smiths and his other workmen; and moreover because the symptoms of that heat-treatment are open to those employees, and, best of all, to himself.

Here the simile ceases to hold good, because whereas a burnt beefsteak cannot be made good, an overheated piece of steel can be restored nearly to its best condition.

Thus, the structure of steel, whether as revealed by the microscope or in the fracture of the metal, is an index, not only to the properties of the metal but to a certain extent also to the

treatment, especially the heat-treatment which it has undergone, and of the further heat-treatment which is necessary to cure any injury which has already been caused.

213. HEAT-REFINING DEFINED. — This is a process for curing by thermal treatment the injury which is done to steel by overheating, *i. e.*, by allowing it to cool undisturbed from an unduly high temperature. This injury is accompanied by a material coarsening of the structure, and indeed this coarsening is probably the immediate cause of the injury. To facilitate the discussion I shall provisionally assume this causal relation.

Before studying this curative process itself, we must, however, familiarize ourselves with the disease which it aims to cure, and with the symptoms of that disease. This we will do in the following sections.

Five important matters require our attention. These are as follows:

(1) The structure may be learned either by microscopic examination, usually of polished and etched sections, or by an examination of the fracture, usually with the naked eye.

(2) Each variety of iron or steel has its own normal type or types of fracture to which it naturally inclines; a type (usually the finest of all), corresponding to the best condition of the metal, another (usually the coarsest), corresponding to the worst condition, *etc.*

(3) Yet the structure of each variety of iron and steel varies very greatly with the heat-treatment which it has undergone.

(4) In particular, the structure of steel, especially of high-carbon steel, is made coarse by overheating, and this coarsening of structure is accompanied by a great injury to the quality of the metal.

(5) The coarseness and the accompanying injury can be removed by a process of heat-treatment called "heat-refining," or by mechanical means which for brevity we may call "mechanical refining" or "hammer-refining."

214. THE STRUCTURE OF IRON AND STEEL. — The micro-structure of the metals in general as determined by examining polished and etched or heat-tinted specimens under the microscope, gives more direct and far more detailed information as to their structure than we can hope to find in the fracture itself; and no doubt we are approaching rapidly the day when microscopic

examination will in very many cases give a trustworthy diagnosis. At present, although the microscope has given invaluable information which has been essential in developing our present knowledge of the metallography of iron and steel, yet its indications are as yet so hard to interpret, thanks partly to the fragmentary nature of the evidence, to the very richness and complexity of the indications in each microsection, to the newness of this method of examination, and to the present very imperfect correlation of our data, that to-day the fracture probably gives, in many cases, indications more trustworthy than those of the microscope.



Fig. 75. Barked Wrought Iron, Stumm.

When a piece of metal is broken, rupture follows the surfaces of least resistance under the existing conditions; and these surfaces are what we see in the fracture.

Certain classes of iron incline readily to yield certain types of fracture; other classes to yield other types. Thus a very fibrous fracture, while readily induced in very ductile specimens of wrought iron, is harder to induce in the less ductile specimens, and cannot be induced at all either in cast iron or in normal high-carbon steel. A very fine, porcelanic fracture can readily be induced in high-carbon tool steel, but cannot be induced readily if at all in low-carbon steel or in cast iron.

Before going on to consider the structure of the metal further, the reader must be cautioned as to the very different kinds of fracture which may be given to one and the same piece of metal by breaking it under different conditions. Thus a bar of wrought iron nicked on one side only, and broken by bending it away from the nick by a succession of light blows, naturally yields a fibrous fracture, of which an extreme case is shown in Fig. 75; but, if nicked on all four sides and broken with a single sharp blow, it yields a bright crystalline fracture. This difference, however, is due to the fact that the surfaces of least resistance vary with the conditions under which rupture occurs. It warns us that tricks may be played in rupture to yield a desired fracture, and that we should be cautious in drawing inferences from the appearance of fractures, especially of those made in our absence.

Finally, and this is the important point to which attention is particularly called, for a given specimen of steel and for given conditions of rupture, the fracture varies very greatly with the thermal and mechanical treatment which the metal has undergone; and as the fracture varies so do the mechanical properties of the metal. Thus, if we know how a test or specimen bar has been broken, either from seeing it broken ourselves or from trustworthy report, the fracture may give very valuable information as to the condition of the metal and the thermal and mechanical treatment which have caused both that condition and that particular form of fracture. What the relations are between the fracture, properties, and treatment will shortly be explained.

215. A COARSE FRACTURE SUGGESTS A COARSE STRUCTURE. — As the surfaces of least resistance which we see in the fracture are in general either crystal faces or cleavages, and as coarse cleavages are naturally associated with coarseness of the crystallization proper, so our natural working hypothesis is that a coarse fracture is simply a symptom of coarse crystallization; and that where the fracture is coarse, there we may expect to find the crystallization coarse. The converse we may also expect, though not so confidently; for fineness of fracture might readily be due to fineness, not of the true crystal size, but of the cleavage. Large coarse crystals might have very poorly defined cleavage, so that when rupture traverses them, instead of traveling long distances along a given cleavage surface, and so revealing large faces in the fracture, *i. e.*, yielding a coarse fracture, it might travel only

a very short distance along a given cleavage plane before leaping across to another, and it might thus reveal in the fracture only minute portions of a great number of different cleavage planes, *i. e.*, a very fine fracture. But as far as our studies of iron and steel have gone, coarseness and fineness of fracture and of crystalline structure seem in general to go hand in hand; and in what follows, the teachings of fracture have to be supplemented in some cases by those of microstructure.

In short, when we speak of the coarseness of the grain of steel as shown in the fracture, we refer naturally to the size of the facets which we there see. And their size is probably in turn proportional to the coarseness of the crystals themselves, or to the coarseness of the network between the crystals of which the metal is made up.

To simplify the discussion we will hereafter refer jointly to the degree of coarseness of the fracture and the degree of coarseness of the microstructure as determined in polished sections under the microscope, as the "grain-size," assuming provisionally that the coarseness of structure in one of these respects is proportional to the coarseness in the other respect. We will further assume, provisionally, that the condition of any given variety of steel is the better the finer is the structure. It is this assumption that gives interest to the whole discussion, and indeed makes it of great importance to the practicing engineer. We shall see later that this assumption, while true in a general way, yet must be modified somewhat to meet varying conditions. For instance, while the general merit of the steel for miscellaneous uses may well be the greater the finer is the grain-size, yet for certain special conditions of use the qualities which accompany the very finest grain attainable may be less desirable than those accompanying a slightly coarser grain.

216. GENERAL LAWS CONCERNING FRACTURE AND TEMPERATURE. — Certain laws will now be formulated, representing some of our present information on this general subject. Let it be distinctly understood that these are simply early attempts to bring together into condensed form the results of our observations, that none of these laws is likely to prove rigorously true, and that most of them may have to be greatly modified later. Nevertheless it is thought that they will be of use as a temporary expedient, that by their aid our present fragmentary knowledge may be not only

more easily used, but also more easily extended, and that our errors may be corrected.

Laws Affecting Region IV of Fig. 68, the Structure of Austenite.— For given kind of steel it appears that for each temperature of region IV there is a normal size or diameter of grain (see end of § 216), and that the grain-size increases with the temperature. (Fig. 76a.) Let

D^n = the normal grain-diameter for given temperature T of region IV, for given steel.

The grain which actually exists at a given temperature in this region may or may not be of the size D^n . Let us call the existing size of the grain of the austenite then D^a to distinguish it from D^n , or

D^a = the existing grain-diameter of a given specimen when at a given temperature in region IV.

It appears that the normal size of grain increases with the temperature throughout region IV; this may be expressed by the following law:

$$[1], D^n : D^{n'} = T : T'.$$

Whether the normal grain-diameter is strictly proportional to the temperature as law [1] indicates, or whether it is proportional to some function of the temperature, remains to be seen. The line *JDG* in Fig. 76 is an attempt to represent this law. Prof. Sauveur and the author obtained for a certain specimen of steel* the expression $T^{\max} = 680 + 281,250 \cdot a$ in which T^{\max} equals the temperature reached, and a equals the actual area of the grain in square millimeters under a magnification of 250 diameters. This goes to show that the normal grain-size is strictly proportional to the temperature. It is in accordance with this that the lower part of this line has been drawn straight. But the curve by which Tschernoff represented the relation between the grain-size and the temperature differed from the line *JDG* as here drawn, in curving to the right through its whole length, from *J* upwards. As his results covered a higher range of temperature than ours a simple explanation is that, whereas the normal grain-size at relatively low temperatures or until the boundary *Aa* of

* The composition of the steel was: carbon, 1.10 per cent; silicon, 0.02 per cent; and manganese, 0.41 per cent. *Eng. and Min. Jour.*, LX, p. 537, Dec. 7, 1895.

region II is reached, is closely proportional to the temperature, yet at higher temperatures it may increase more rapidly than the temperature. With this in view, I have curved the upper part of this line.

We may, however, for simplicity, retain the form of law [1] already given, although it strictly implies that the line JDG

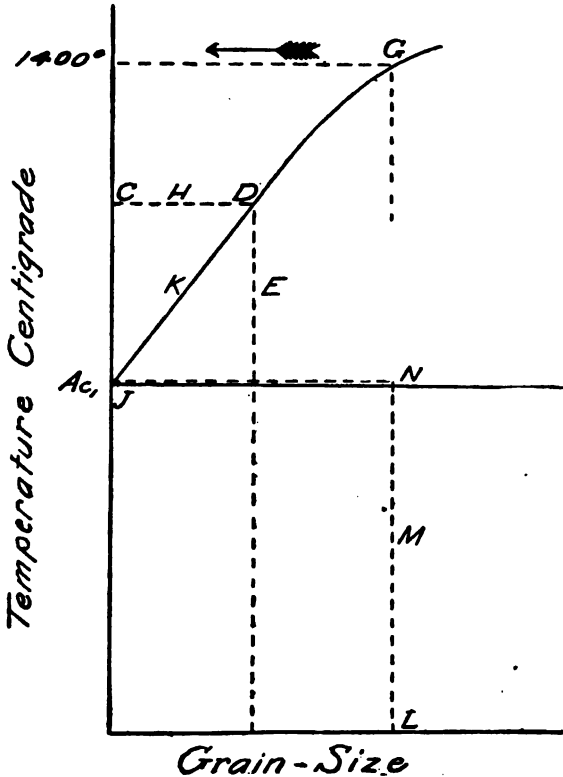

Fig. 76. Law [1]. The Normal Grain-size of Eutectoid Steel in Region IV. First Approximation.

is straight throughout. The slight inconsistency implied need not trouble us, if we remember that both the line JDG and the formula of law [1] are given as first approximations only; and that a formula prepared to fit the line as drawn might well deceive in implying for our knowledge a far greater degree of accuracy than it has.

Second Law of Grain-size. — At any given temperature in region IV, if the existing grain is smaller than that normal for the temperature, then the grains grow until they reach the normal size; or

[2] if $D^a < D^n$, D^a grows to D^n .

This growth is by no means instantaneous, but may occupy many hours. It is probable that the growth is at first very rapid, and becomes slower and slower as the existing size approaches the normal size.

Third Law of Grain-size. — If the existing grain is larger than that normal for the existing temperature in region IV, it does not shrink back towards the normal size, or

[3] if $D^a > D^n$, D^a does not shrink towards D^n .

An example may illustrate this. If in Fig. 76 we heat a piece of steel to say temperature C , and if we assume that the grain at the moment of reaching that temperature is of the size represented by H , then if the temperature remains at C the grain will progressively grow until it reaches the grain-size D , corresponding to C . If now, having reached this size, the steel is cooled to temperature E , the grain will remain of the size D , and therefore be far to the right of K , which represents the normal size for the temperature E .

Fourth Law of Grain-size. — If, now, we let

T^{\max} = the highest temperature reached in the last sojourn in region IV,

and if we assume that the changes of temperature have been very slow, so that the grain has had opportunity to grow approximately to the size normal to T^{\max} , then it follows from laws [1], [2] and [3] that the existing size of grain should be proportional to T^{\max} ; hence law [4],

[4] $D^a : D^{a'} = T^{\max} : T^{\max'}$.

This represents in a general way the law governing the size of the grains which we find in hardened, *i. e.*, suddenly cooled steel, which we may take to represent the size which the grain of austenite reached at the highest temperature touched in region IV.

As far as our present purpose is concerned it would have sufficed to define T^{\max} as the highest temperature reached, without adding "in the last sojourn in region IV"; but we shall shortly see why this restrictive clause is added.

Laws Affecting Region VI and probably the left-hand part of region IX. Regarding this region from the point of view of its consisting of pearlite together with an excess of either ferrite or cementite over the pearlite ratio, we may let

D^p = the diameter of the grains of this region, or the pearlite diameter.

When steel cools from region IV into region VI it appears that the size of the grain which arises in region VI is at least roughly proportional to the grain which has existed in region IV, or law [5],

$$[5] D^p : D^{p'} = D^a : D^{a'}$$

Indeed there is reason to think that the grain-size existing in region IV is the same as that to which it gives rise on passing into region VI: or in short (law [6])

$$[6] D^p = D^a.$$

Or in other words there is apparently no change of grain-size in steel on cooling past the critical range.

Thus it appears that there is no special grain-size to which each temperature in regions VI and IX corresponds; but that the steel in these regions simply inherits the grain-size which it had received in region IV.

Seventh Law of Grain-size.—From laws [4] and [5] it follows that if the steel has been exposed long enough to the highest temperature reached in region IV to grow to the size corresponding to that temperature, then the grain-size even after slow cooling will be proportional to that highest temperature, or law [7],

$$[7] D^p : D^{p'} = T^{\max} : T^{\max'}$$

Indeed, this law should hold good in a rough way even if the foregoing conditions are not accurately complied with. Thus, if two like pieces of steel are heated to different temperatures in region IV, but at approximately like rates, then even if their sojourn at their highest temperature is not long enough to give each the full grain-size corresponding to that temperature, yet each will approach that limit of size towards which it tends. The grain-size of the more highly heated, growing towards its greater limit of size, will be correspondingly greater than the grain-size of the less highly heated, because the limit towards which the former tends is greater than that towards which the latter tends. Of these two pieces, then, it will be roughly true

that the grain-size is proportional to the highest temperature reached in region IV, which is law [7].

Fig. 76a shows how the grain-size of the slowly cooled steel, or D^p , increases with the temperature to which the steel has been heated in region IV. Note the very coarse meshwork of the steel heated to 1339° , the finer meshwork of that heated only to 1212° , and the still finer meshwork of that heated only to 966° .

A most important inference from this law is that an inspection of the fracture, or of the microstructure in a polished section, indicates whether the steel has been unduly heated or not. To

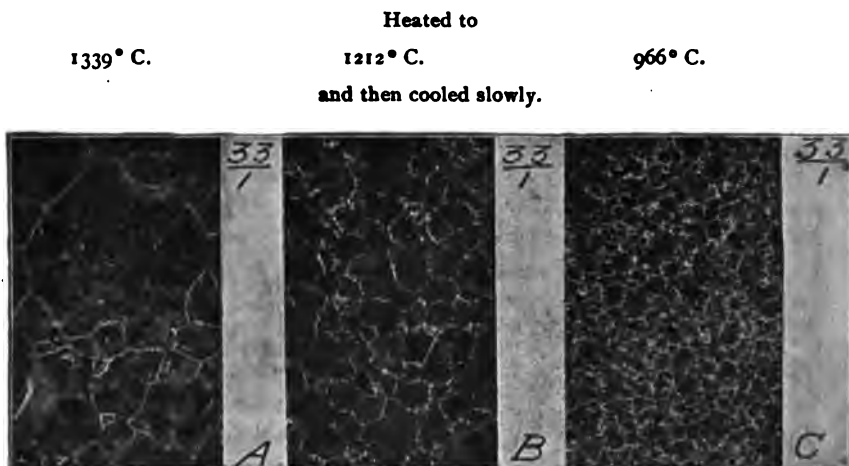

Fig. 76a. Influence of the Highest Temperature Reached (T_{max}) on the Size of the Grain of Slowly Cooled Steel. 33 Diameters.

Steel of 0.50 per cent of carbon.

Wm. Campbell, in the Author's Laboratory.

the practiced eye it indeed gives a surprisingly close measure of the temperature reached in region IV, of course not absolutely in degrees Centigrade, but relatively. It is probable that before many years we shall be able to formulate these laws with some precision, so that even the relatively unskilled can tell from the grain-size in the polished section to what temperature in region IV the steel has been heated, if the composition is known, and if the known conditions of the case tell us in a general way what the rate of heating has been. Such information can often be had

from the known conditions of the heating-furnace, the size of the piece treated, etc.

217. *Eighth Law, HEAT-REFINING.*—This is probably of more direct practical importance to the practicing engineer than any of the other matters here considered. We may consider two sets of conditions, 1st, that applying to steel of about 0.90 per cent of carbon, *i. e.*, æolic steel, and 2nd, that applying to steel containing less carbon, *i. e.*, hypo-eutectoid steel.

Heat-refining of Eutectoid Steel.—If a piece of eutectoid steel which has been made coarse-grained by high heating in region IV, is cooled into region VI (whether to the room-temperature or only to some higher temperature in region VI), and is then reheated into region IV, during this passage across its narrow transformation region (represented in Fig. 68 as the point *S*), the old coarse grain, D^a , is broken up and a new finer grain results. This new grain will then become proportional to the temperature reached in this present sojourn in region IV. To show this let us turn again to Fig. 76. Let us suppose that a piece of steel has been heated to 1400° and has acquired the coarse grain of the size G , corresponding to that temperature, and let us further suppose that it is then cooled completely.

The grain-size of the cold steel may be represented by letter L . Suppose now that this steel is again reheated as shown by the dotted line LMN . Apparently no change in the grain-size is reached until the temperature rises past Ac_1 , *i. e.*, until the steel enters region IV. But when this occurs, the old coarse grain appears to be completely wiped out, and a new grain, extremely fine, is established. The grain-size seems to follow line $LMNJ$. This may be called "Heat-refining."

This gives us law 8, *heat-refining, if the temperature of eutectoid steel is raised past the transformation-point Ac_{1-2-3} , the pre-existing grain is effaced and replaced by an extremely fine grain.*

The grain acquired in thus rising past Ac_{1-2-3} is so fine that the steel is often said to become amorphous; let this give us an idea of the extreme fineness, although it is more accurate to speak of such fine grain as porcelanic than as amorphous.

If, now, the temperature is further raised, then, quite as in the previous sojourn in region IV, the grain-size begins increasing with the rise of temperature along line JDG ; and, after the steel is again cooled, its new grain-size, D^p , will represent the highest

temperature reached in this last sojourn in region IV. It is thus the last sojourn in this region that determines the grain-size, both D^a and D^p ; and it is for this reason that T^{\max} was defined as the highest temperature reached in the last sojourn in region IV. We see that law [7] should hold good with this T^{\max} thus defined.

Let it be distinctly understood that this refining is a thing which accompanies a rise past Ac_{1-2-3} but does not accompany cooling past the corresponding Ar_{2-2-1} . In other words overheated and coarsened steel is refined by heating from region VI or IX into region IV, but it is not refined by cooling from region IV into region VI or IX.

Hypo-eutectoid Steel. — The heat-refining changes which in case of eutectoid steel occur together at the triple critical point Ac_{1-2-3} , are in case of hypo-eutectoid and probably also of hyper-eutectoid steel, spread out over the whole of the transformation range, regions V and VIII.

The conditions of heat-refining here seem to be that pre-existing coarse structure is gradually weakened, without being changed in degree of coarseness, as the temperature rises from Ac_1 to Ac_3 , *i. e.*, rises across region V; that the coarse structure finally disappears when the temperature enters region IV; and that during its weakening a new growth of grain-size within it occurs, starting at Ac_1 and continuing both across region V and through region IV. If Ac_3 is far above Ac_1 , as happens when the carbon is very low, then by the time the old grain has been wiped out by the passage across Ac_3 the new grain which will have formed will be of considerable size; hence there is no such sharp refining effect with this steel as we find in case of eutectoid steel, because the old coarseness cannot be wiped out fully except by permitting a considerable growth of the new grain to occur.

If, on the other hand, Ac_3 is but little higher than Ac_1 , *i. e.*, if region V is short (as in case of steel which is but slightly hypo-eutectoid), then the wiping out of the old coarse grain at Ac_3 takes place at so short a temperature-interval above that at which the new grain-growth has begun, that this new grain reaches only a small size; hence the heat-refining of such steel is nearly as complete as that of eutectoid steel.

In order to understand this condition of affairs, let us refresh our memory as to what it is that occurs as the temperature

crosses region V (Fig. 68). In cooling from region IV, when the temperature crosses *GHS* and enters region V, the excess of iron present over the eutectoid ratio of 99.1 per cent iron and 0.90 per cent carbon begins to separate out within the austenite, under many conditions forming a network, the coarseness of which depends upon the temperature which has been reached in region IV. In other words, the ferrite-excess which separates out as the temperature sinks below A_r , habitually segregates itself as a network, which may be continuous or rudimentary. But whether continuous or rudimentary its coarseness, in the sense of the size or width of the meshes which it encloses, is the measure of the grain-size. If these meshes are coarse, the grain-size is coarse; indeed each mesh with its bounding network may be considered as a grain. The size of these grains increases with T^{\max} .

As the passage across region V continues, the separation of ferrite progresses, so that the ferrite network between the remaining austenite grains progressively thickens and becomes more strongly marked. This continues until the temperature reaches A_{r1} , the lower boundary of region V, by which time the remaining meshes of austenite have gradually expelled into the encircling network all excess of iron over the pearlite ratio, *i. e.*, the hardenite ratio of 99.1 iron: 0.90 carbon; so that we now have a ferrite network of maximum thickness, encircling meshes of hardenite, *i. e.*, austenite of eutectoid composition. As the temperature sinks past A_{r1} , *i. e.*, as the recalescence takes place, the austenite meshes change into pearlite, apparently without changing the encircling ferrite meshwork. For simplicity of description I pass by the progressive nature of these transformations, from austenite through the conditions of martensite, sorbite, and troostite, into pearlite. These are important, but not for our immediate purpose here.

As cooling continues through region VI this structure seems to persist unchanged, and indeed to remain unchanged during subsequent heating, until, as in heat refining, region V is again reached. On recrossing this region the changes which we have just traced again occur, of course in reverse order. That is to say, as the temperature rises past A_{c1} the pearlite of the meshes changes back into austenite of eutectoid ratio; as the temperature rises farther the network of ferrite is progressively reabsorbed by the austenite meshes, and thus grows thinner and thinner, but apparently with-

out changing the size of the network. On thus reheating pieces cut from an ingot of hypo-eutectoid steel (carbon 0.56, silicon 0.14, manganese 0.18, phosphorus 0.02, sulphur 0.02), I could see, by comparing different pieces heated to different temperatures in region V, how the ferrite network gradually melted away, quite as narrow spines of ice would if floating in warm water. By the time the upper boundary of region V, Ac_3 , had been reached, this network completely disappeared; its absorption by the austenite meshes had completed itself.

This progressive re-absorption of the ferrite network is what causes the gradual weakening of the old coarse structure, developed during the prior high heating in region IV. And the fact that this reabsorption is unaccompanied by any change in the situation of the individual members of the network, or in other words in the coarseness of the meshes which that network encloses, is the reason why the old coarse structure, as it fades and becomes feebler, still retains its old degree of coarseness. It has less and less effect in determining the path of rupture; but in so far as rupture follows this old coarseness, it yields the same old degree of coarseness of fracture.

But, while the old coarse structure has thus been fading away, a new and quasi-independent structure has been building up. For, following law [1], $D^n : D^{n'} = T : T'$, the austenite of the meshes is forming itself into new grains within the old network. These grains are grains of austenite not surrounded by any new network of ferrite, unless, having raised the temperature part way across region V we again lower it, in which case the ferrite which falls out of solution in the austenite as this cooling through region V progresses will form a new ferrite network, which will encircle these new austenite grains. In this case if we cool the steel completely, we find a two-fold network, (1) the remains of the older coarse structure, more or less effaced according to whether the temperature has risen much or little above Ac_1 ; and (2) within it the new, finer, ferrite network formed in the excursion into region V which has just taken place.

Thus it is that steel which is much hypo-eutectoid is not thoroughly refined by this process of heat-refining, because if the excursion into region V goes far enough to efface thoroughly the old coarse network, then the new ferrite network will, because of the extent of this excursion, because of the temperature interval

between Ac_1 and the limit of that excursion, be of very considerable size.

The researches of Mr. K. F. Göransson* when a student in my laboratory went to show that this is true of hyper-eutectoid steel also, in a general way.

217A. TO FIND THE TEMPERATURE OF HEAT-REFINING. —

In case of steel containing between 0.40 and 0.90 per cent of carbon, the upper critical point, Ac_{2-3} , at which refining is completed, is that at which the magnetic properties are lost, apparently by the change of the magnetic *alpha* ferrite to the non-magnetic *gamma* iron of the austenite. So it comes that the refining temperature, in the sense of that necessary to complete the refining, is that at which the metal ceases to be magnetic. This temperature may readily be detected by noting whether the steel is or is not magnetic. A dipping needle can readily be made by hardening a high-carbon steel wire, magnetizing it, and mounting it in a small wooden roller. In seeking to learn the refining temperature, the steel which we are treating is heated slowly and from time to time removed and held beside such a needle, so as to learn whether it is still magnetic. In case of large steel objects a small piece of the same steel should be heated alongside of the large piece, and used for testing for magnetism.

217B. STEAD'S BRITTLINESS.—The fact that the proportion between the free ferrite and the pearlite in very low-carbon steel is very different from that in high-carbon steel, naturally leads to somewhat different phenomena of heat-treatment, of which a very important one has been discovered by Stead.†

He found that, if the carbon-content is extremely low, say between 0.025 and 0.12 per cent, then the grain grows progressively coarser as the temperature rises from about 500° C., and instead of being refined, continues growing as the temperature passes Ac_1 , say 700°, and beyond this continues growing, apparently until the temperature reaches Ac_2 . From this point on no material change in size appears to take place until a temperature of about 900° C. (Ac_3), is reached, when the coarse grain is broken up and becomes refined.

* "The Effect of Reheating upon the Coarse Structure of Over-Heated Steel," *Trans. Am. Inst. Mining Engineers*, to appear.

† *Journal Iron and Steel Institute*, 1898, I, p. 145, and 1898, II, p. 137.

His results are expressed graphically at *A* in Fig. 77, and for ease of comparison the corresponding behavior of eutectoid steel is roughly sketched at *B* in the same figure. The dotted line in part *A* of this figure is to indicate that the grain of the austenite which is present at temperatures above Ac_1 , begins increasing in size from the time when it begins to form, *i. e.*, as soon as the temperature rises above Ac_1 .

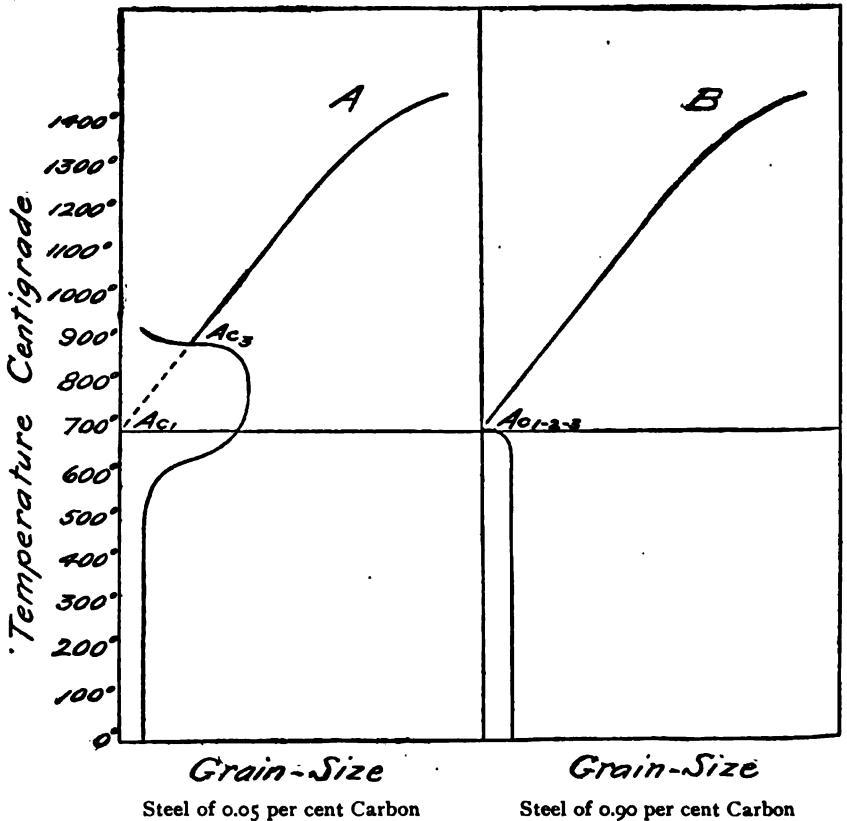

Fig. 77. Conjectured Relation between Temperature and Size of Grain of Steel. First Approximation.

In both classes of steel we have the phenomenon of the refining on passing Ac_3 ; in the low-carbon steel we have in addition the coarsening and embrittling on slow rise of temperature through the upper part of region VI. It is noteworthy and indeed natural,

that both forms of brittleness, that caused by overheating higher carbon steel, and that due to long exposure to a temperature of 500° to 700° in case of low-carbon steel, are cured and the metal is refined on heating past Ac_3 ; for in each case what here occurs is that the absorption of the ferrite by the austenite completes itself. In heating toward Ac_3 the quantity of free ferrite becomes progressively less; but as its absorption by the austenite progresses, its geographical position, if I may say so, does not appear to change; so that, as already pointed out, the size of the grain remains unchanged. It is on passing Ac_3 that the absorption of the ferrite completes itself, that this ferrite, the coarse granulation of which has caused the coarse grain and brittleness, itself disappears, and with it much or even in some cases all of the coarse grain and brittleness which had been caused.

So far, then, the two classes of steel behave in general alike, as is to be expected. But that they should behave differently on rising slowly through the upper part of region VI is not surprising, as the least reflection shows us. For if the carbon is from say 0.45 to 0.85 per cent, then the steel as a whole, in its slowly cooled or pearlite state, consists of a large important ground mass of pearlite, penetrated by a rather thin network of ferrite. If the carbon is very low, say from 0.025 to 0.12 per cent, as in the steels studied by Stead, then on the contrary the pearlite, instead of forming the greater part or at least an extremely important part of the whole, forms simply small scattered masses, in a great excess of ferrite. Under these conditions the coarsening and embrittling of low-carbon steel in the upper part of region VI are naturally referred to a coarsening of the ferrite, rather than to any change in the pearlite.

It remains to be seen how far like effects can be induced in higher carbon steel. Should it prove that steel of this kind is not subject to this ailment, or only subject to a mild form of it, we need not be surprised; for we naturally refer the grain-size of this steel to the size of the meshes of pearlite enclosed in the network of ferrite, rather than to the grain-size of the ferrite in that network.

218. BURNING.—Up to this point we have been considering only moderate overheating. But if the overheating is extreme, then the cohesion between the adjacent grains becomes so feeble that they are forced apart to a certain extent by gas evolved from

within. This gas probably consists, at least in part, of carbonic oxide, formed by the union of the infiltrating atmospheric oxygen with the carbon of steel; though dissolved gases, hydrogen and nitrogen, may also contribute, being thrown out of solution by the rise of temperature. Such steel is said to be "burnt" as distinguished from that which is simply overheated; and we may provisionally adopt this distinction, that burning consists in a mechanical separation of the grains on extreme overheating.

There is another feature of burning, the great thickness of the network of ferrite which forms when this highly overheated and hence very coarse-grained steel cools through region V.

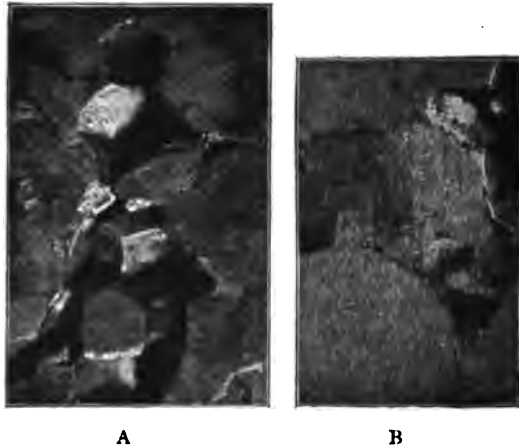

Fig. 78. Burnt Steel of 0.50 Carbon. 33 Diameters.
Made by W. Campbell, Ph.D., in the Author's Laboratory.

Burnt steel is recognized by its extreme brittleness both hot and cold, its coarse, shining fracture, and the oxide coating which we often find in that fracture. It is quite possible that the coarseness of this ferrite network may contribute to the effects of burning; but it is not easy to understand how it should come about that this alone and by itself should suffice to make the steel so incurably brittle. It should be possible to break up, by mechanical kneading, if not indeed by simple thermal treatment, the effects of this microscopic segregation of ferrite.

Fig. 78 shows the microstructure and also (in A) part of the fracture of burnt steel. The fracture was polished down, and the

parts here shown as level were then etched. They show the coarse grain of the austenite, especially when the small magnification (33 diameters) is taken into account. The depressed parts in A show the brightness of the fracture, and the smoothness of the surfaces along which rupture passes.

Burning, at least if extreme, cannot be cured by either heat-refining or mechanical refining. That heat-refining cannot cure it is natural enough. This process acts through inducing a metamorphic change in the continuous parts of the metal; its very nature shows us that it can have no power to close up mechanical gaps actually existing.

The following results obtained by one of my assistants illustrate roughly how the injury caused by overheating increases with the temperature reached, and how the curative power of heat-refining diminishes as the temperature passes from region IV into region II. Although these results have been on exhibition in my museum for some years, I owe this suggested generalization, that burning sets in with the passage from region IV into region II, to Professor Stansfield. Note that although exposure to a temperature of 1250° made the steel so brittle that it broke when bent through 14°, yet after refining it bent 144° before breaking. With higher heating the brittleness was only slightly increased, but the remedy which refining caused was relatively slight.

TABLE II. — *Brittleness Caused by Overheating, and its Cure by Heat-refining.*

APPROXIMATE TEMPERATURE (C.) TO WHICH THE STEEL WAS HEATED	DUCTILITY OF $\frac{5}{16}$ INCH SQUARE BARS OF STEEL OF 1.20 PER CENT CARBON ANGLE THROUGH WHICH THE PIECE BENT BEFORE RUPTURE	
	Bar not Refined	Bar Refined
1250°	14°	144°
1300°	7°	21°
1350°	4°	10°
1400°	3°	0°

It is in conformity with this idea that high-carbon steel is so much more liable to be burnt than low-carbon steel. The difference between these two classes in susceptibility to burning is too

great to be referred to the difference in the temperature at which freezing begins; it is to be referred rather to the steepness of the left-hand boundary *Aa* of region II. A natural inference, which should be tested, is that it is this boundary which determines the forging limit of temperature, as well as the temperature of burning. It is, indeed, to be expected that in any event the steel should be unforgeable in region II, because here it normally consists of a mechanical mixture of frozen austenite and of molten carburized iron. Such a mixture, part molten, part solid, could hardly be forgeable; the blows of the hammer should squeeze out the molten matter, and the whole should fall to pieces. This, indeed, is one of the familiar things which happens when we try to forge steel while it is at a burning heat.

As a palliative for burning, mechanical refining by rolling, *etc.*, is much more effective than heat refining, as we should naturally expect. For while heat refining should be powerless to close up even the most minute cracks, the compression and kneading which accompany mechanical refining should have a powerful effect in closing cracks even of considerable size, especially if their sides have not become coated with iron oxide.

218A. WHY DO NOT INGOTS AND OTHER CASTINGS BURN IN COOLING THROUGH THE BURNING RANGE?—It will at once be asked, how then is it ever possible to put into good condition any steel which has been cast in a molten state into ingots or other castings, since these evidently have in their initial cooling passed through every temperature between their melting-point and the cold, and hence necessarily through this range in which "burning," this incurable disease, occurs? Certain it is that ingots and other castings in thus cooling do not undergo burning, although steel bars heated to this temperature, whether cooled suddenly or slowly from it, are found when cold to have been incurably burnt.

Three explanations suggest themselves:

(1) That the burning is connected with the rise as such of temperature, and that simple cooling through this temperature cannot induce burning.

True it is that heating through a given range of temperature may have quite a different effect from cooling through it. But it often happens that a steel ingot, of which the outer shell has solidified while its interior is still molten, is set in a special form of heating-furnace called a soaking-pit; and parts at least of the

already frozen shell then are reheated very close to the melting-point by the heat of the still molten interior. Yet such ingots are not thereby burnt, although there has been a rise of temperature through the very range in which a bar of steel is burnt. Here then this explanation breaks down, and we reject it as incompetent.

(2) That burning is due to oxidation of the faces of the crystalline grains which compose the metal, by the inward diffusion of the atmospheric oxygen. These films of iron oxide, thin and discontinuous though they may be, may indeed be so distributed as to cause great weakness along certain planes; hence the injury which the high temperature causes. But when an ingot or casting is cooling from the molten state it gives off much hydrogen which had been dissolved as such or "occluded" in the molten metal. The outward working of this hydrogen may both mechanically restrain the oxygen from entering, and also counteract it. This explanation seems reasonable. It could be tested by learning whether a bar of steel heated close to its melting-point in *vacuo* or in an atmosphere of hydrogen is incurably burnt.

The explanation then is that in this burning range ingots and castings in their initial cooling are not burnt because protected by their evolution of hydrogen; but that bars of steel made from those ingots, having lost that hydrogen, are burnt in this range by penetration of the atmospheric oxygen along the crystal faces.

(3) That whether the burning is due to extreme coarseness of grain and to setting between the adjacent grains a network of ferrite so thick that to break it up and redistribute it is very difficult; or whether it is due to intergranular oxidation, the mechanical distortion and kneading which an ingot undergoes in rolling or hammering down into a bar is much greater than that which a bar can undergo in rolling or hammering down into a smaller bar; and that the former greater kneading suffices to break up and undo the work of burning much more thoroughly than the latter. The greater kneading which an ingot undergoes cures burning, while the slight kneading possible in reworking a steel bar does not.

This explanation does not suffice to show why a steel casting, which undergoes no mechanical work at all, is not burnt by cooling through the burning range. It is therefore incompetent to explain the phenomenon by itself. But, as castings in cooling

are generally protected from atmospheric oxidation by their moulds, this third explanation may be valid as contributory to the second. In other words, the fact that steel bars are burnt in a range in which ingots are not, may be due jointly to (2) the protection of the ingot by its own hydrogen from oxidation, and (3) to the more thorough breaking up of such thinner films of oxide as do form into relatively harmless minute separated particles through the greater kneading of the ingot.

We may therefore provisionally accept the second explanation, with the third as perhaps contributory.

219. MECHANICAL REFINING. — The coarse grain and its attendant brittleness induced by heating steel to the upper part of region IV can be cured by such mechanical distortion as occurs in rolling, hammering, and like operations. As austenite appears to belong to the isometric or cubic system, so its grains are normally equiaxed. The mechanical distortion in rolling and hammering elongates these grains in the direction of rolling and shortens them in the plane of the pressure; this appears to throw the metal crystallographically into unstable equilibrium, with the result that the old grains thus distorted break up, and that the metal re-arranges itself into new and equiaxed grains.

But these new grains assume a size normal, not to the temperature at which the old ones had formed, but rather to the temperature now existing; during the rolling or hammering the temperature is constantly falling; each pass through the rolls, and each blow of the hammer tends more or less fully to break up the pre-existing grain, and to substitute for it a new grain of a size more nearly normal to the now lower temperature. To speak more accurately, the new grain-size approaches that normal for the existing temperature; but the result is much the same. For if each of a succession of passes through the rolls breaks up the existing grain, and substitutes for it a new one, then each new grain will be smaller than the preceding, because the normal towards which it tends is smaller than the normal towards which its predecessor tended at the higher temperature then existing. (See end of § 219*A*.)

Fig. 79 attempts to express this condition of affairs graphically. Here ordinates represent temperature and abscissæ coarseness of grain. The line Ac_1A may be taken as representing roughly the normal size of grain, D^n , which steel of given com-

position tends to assume with varying temperature, or the line of normal coarseness of grain. If the grain is smaller than the normal for existing temperature it always tends to grow and to approach that normal (law [2]). If it is coarser than that normal it does not tend to shrink back towards the normal (law [3]), except when the temperature is *rising* past Ac_3 (law [8]).

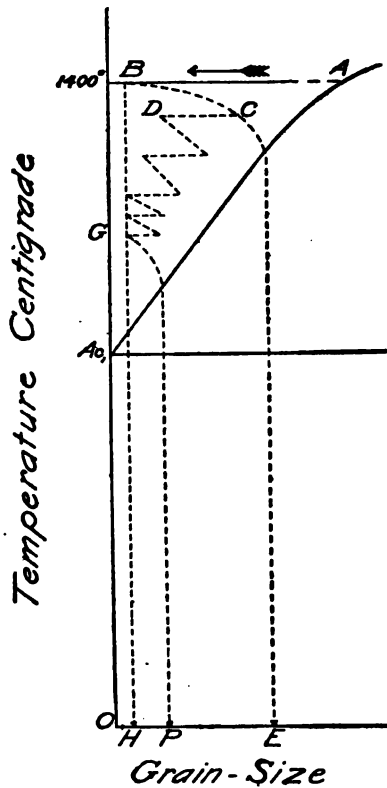

Fig. 79. The Influence of the Finishing Temperature on the Size of Grain.

Let us suppose that we cease rolling a piece of steel while its temperature is at B , the mechanical work of the rolls having broken the grain down. During subsequent cooling the grain will grow, somewhat as sketched in the line BCE . If, however, we resume rolling when the grain has reached C , we will again break down

the grain, and drive it back, say to D . And so, keeping on, between passes the grain grows and the temperature simultaneously falls, while at each pass the squeeze which we give the metal breaks up the grain, and the curve of grain and temperature follows the zigzag line $BCDG$.

If we cease rolling when the temperature has fallen to G , then the grain will grow as the metal cools, till the line of the actual size of grain intersects that of the normal size, the line Ac_1A ; with further cooling no further growth ensues, and the final size of grain is OP . If we had quenched the metal while at G , the final size of grain would have been OH . If we had ceased rolling when the temperature was at B , the final size of grain in the cooled steel would have been OE . Needless to say, far from pretending that these curves are drawn to scale, I cannot even insist that their general teaching is true: but it certainly seems to harmonize with our phenomena.

219A. FINISHING TEMPERATURE. — If the foregoing views are correct, then it follows that the size of the grain will be the smaller the lower is the temperature at which the last distortion occurs, whether this distortion is caused by the last pass in the rolls or by the last effective blow of the hammer. Or roughly speaking, the grain-size will be the coarser the higher the finishing temperature; this we may call the ninth law, or that of finishing temperature,

$$[9] D:D' = FT:FT',$$

in which FT represents the effective finishing temperature.

Fig. 79a illustrates this principle. This shows the microstructure of two like bars of the same steel, of which each had first been heated to 1394°C ., then cooled slowly to the temperature indicated in the figure, then rolled, and then cooled slowly, so that these temperatures are the "Finishing Temperatures." Note how much coarser the meshes are in A , finished at 963°C ., than in B , finished at 837° .

This principle of governing the grain-size by means of the finishing temperature is of very great importance. In general we should be inclined by considerations of economy of power to roll or hammer steel as hot as we dare, because the hotter it is the softer it is, and the less power is consumed in rolling or hammering. But this would naturally lead to a high finishing temperature, and thus to coarseness of grain and brittleness. Hence a

some cases when part of the rolling from bloom to rail has been done, and when the metal in the intermediate stage of "billet" is reheated slightly, the part which is to form the head is purposely kept cooler than the rest by keeping the billet as it were on its head, *i. e.*, by putting the head part down in contact with the furnace bottom, while the part which is to form the flange lies uppermost and is fully exposed to the heat. Again, during the rolling, the part which is to form the head may be specially cooled by strong jets of cold water.

In particular the Kennedy-Morrison process* interrupts the rolling before the last pass, so as to allow the rail to cool and thus to give it a lower finishing temperature.

For welding, the two pieces which are to join are in general so shaped beforehand as to be much thicker at the point of junction than the finished and welded piece is to be. Hence, after welding proper, *i. e.*, after the first few blows which cause the two pieces to cohere firmly, the smith continues hammering so as to reduce the local thickness here to that aimed at in the finished piece, and this hammering is prolonged until the temperature has sunk to a harmlessly low point. The ultimate object of all this procedure is to give the metal at and about the weld, which has perforce been very highly heated so as to permit welding, a relatively fine grain and its attendant good qualities through having the finishing temperature low. The object, in short, is to permit this "mechanical" or "hammer" refining of the necessarily overheated parts.

We are only just beginning to accumulate data as to the therapeutic effect of mechanical refining. It is hardly to be supposed that, in rail-rolling, if all the passes except the last take place at a very high temperature, and that then the last pass only is at a proper temperature, this last pass will cure completely and surely the injury done by the previous high heating, especially if the amount of mechanical work, *i. e.*, the reduction of cross-section, in this last pass is very slight, as is almost necessarily the case. Thus, if we compare the grain-size of Fig. 76a with that of Fig. 79a, we see at once that the grain of the piece rolled at 963° . after slowly cooling from 1394° (*A*, Fig. 79a), is very much coarser than that of the piece (*C*, Fig. 76a), which was simply

* *The Iron Age*, LXVI, Dec. 20, 1900, pp. 16-18.

heated at 966° and then cooled slowly. Certainly, the degree of mechanical refining here done, while it has reduced the grain-size, has by no means brought it down to the size corresponding to this same temperature as T^{\max} . In other words, the grain-size for a given temperature taken as T^{\max} is much finer here than that corresponding to the same temperature taken as finishing temperature. Whether with greater reduction in the rolls the grain-size for given finishing temperature would be nearly the same as that corresponding to the same temperature as T^{\max} , remains to be seen.

219 B. FURTHER CONSIDERATION OF THE INFLUENCE OF T^{\max} ON THE PHYSICAL PROPERTIES. — It has been pointed out already that, while the coarseness due to extreme overheating is accompanied by very great injury, and while it is true as a rough generalization that the quality of a given variety of steel is the better for most purposes the finer its grain, yet this is true only when we compare grains differing much in fineness, *e. g.*, very coarse grain with very fine grain. When we come to consider the properties corresponding to different sizes of grain all of which are fine, and all therefore due either to a low T^{\max} or to low finishing temperature, we have to qualify this law very greatly; and we find that in certain respects a very low T^{\max} or a very low finishing temperature may be much less desirable than one slightly higher.

It would be well if we could proceed at once to study the relation between grain-size and physical properties of direct importance to the engineer, tensile strength, elastic limit and ductility; but unfortunately we have little direct evidence bearing on this relation. We therefore turn to the relation between T^{\max} and finishing temperature on one hand, and these physical properties on the other. Even here our knowledge is as yet extremely fragmentary; but to facilitate the study of such data as are at hand I have plotted in Figs. 79b, 79c, and 79d the results obtained by Ball and by the Westinghouse Machine Co., together with those of several investigations in my own laboratory. Further I give in Table 12 some later results which I have reached while this work was in press, with the assistance of Mr. I. C. Bull, who performed the manipulations, and in Table 13 the results obtained by Dr. Wm. Campbell in my laboratory.

Looking at these results in a general way, we note first that they verify the generalization made long ago, that the influence of

TABLE 12.—*Influence of the Temperature from which Steel is Cooled Slowly upon its Physical Properties.*

Steel No. 164	Carbon 0.035	(Si .093	P. 0.093)	
SLOWLY COOLED AFTER HEATING TO	TENSILE STRENGTH POUNDS PER SQUARE INCH	ELASTIC LIMIT POUNDS PER SQUARE INCH	ELONGATION PER CENT IN 8 INCHES	REDUCTION OF AREA PER CENT
750° C.	28,353	19,948	28.00	79.72
1100° C.	28,057	18,130	30.00	78.37
1300° C.	28,529	12,142	35.00	77.01
1400° C.	30,064	11,483	13.25	76.46

Steel No. 39	Carbon = 0.22	(Mn = .44	P = .008	S = .018)
750° C.	52,608	30,715	15.25	68.54
1100° C.	52,374	19,242	15.00	61.84
1300° C.	52,241	19,159	19.25	58.77
1400° C.	50,313	12,880	—	56.62

Steel No. 193	Carbon = 0.70	(Si = .141	Mn = .068	P = .012	S = .019)
750° C.	82,660	40,062	12.00	25.42	
1100° C.	92,342	59,363	13.12	20.35	
1300° C.	48,921	29,247	1.12	17.22	
1400° C.	41,327	33,082	1.25	15.10	

Steel No. 46	Carbon = 0.92	(Si = .124	Mn = .240	P = .014	S = .025)
750° C.	81,087	34,710	13.50	43.66	
1100° C.	109,586	39,226	7.50	14.14	
1300° C.	106,913	33,992	4.50	7.88	
1400° C.	64,189	42,008	0.50	5.13	

Steel No. 192	Carbon = 1.04	(Mn = .12	P = .012	S = .017)
750° C.	83,046	51,400	13.75	53.84
1100° C.	107,814	65,926	10.37	22.17
1300° C.	88,376	48,643	3.37	16.23
1400° C.	46,055	32,051	0.87	11.24

Four test pieces were cut from each of five lots of steel. They were then heated extremely slowly to the temperatures indicated. In each heating five test pieces, *i.e.*, one from each of the different lots of steel, were set compactly side by side within a long narrow muffle, with the thermo-couple of a Le Chatelier pyrometer in their middle. The muffle closed at each end, was completely enclosed in a special cylindrical gas forge, also closed at each end, and in such a way that both ends of the muffle were within the flame of the forge. The temperature was then raised very slowly, especially towards the end of the heating, until the desired temperature was reached. The steel was then allowed to cool slowly within the muffle. The manipulations were performed by Mr. I. C. Bull under the author's directions.

thermal treatment increases rapidly with the carbon-content (note that the lowest-carbon steel, with only 0.035 per cent of that element, is practically unchanged as regards tensile strength and reduction of area, even by heating to 1400°).

TABLE 13.—*Influence of Finishing Temperature upon the Physical Properties of Steel of 0.50 per cent of Carbon.*
W. Campbell.

BAR NO.	SERIES NO.	BARS COOLED FROM	ROLLING TEMPERATURE CENTIGRADE	TENSILE PROPERTIES			
				Tensile Strength Pounds per square inch	Elastic Limit Pounds per square inch	Elongation Per Cent in 8 inches	Contraction of Area Per Cent
A	—	1390°	Not rolled	102,000	60,700	3.4	5.5
1	1	1399° C.	874°	119,700	110,200	—	16.6
2	"	"	820°	123,000	96,500	9.	26.3
3	"	"	749°	109,500	77,000	7.	20.5
4	"	"	Ar 2-3 is 700° ± 686°	111,600	79,200	5.25	8.3
1	2	1394° C.	963°	126,800	86,050	9.6	28.0
2	"	"	909°	127,400	86,800	10.25	27.0
3	"	"	837°	128,300	84,400	10.25	29.7
4	"	"	809°	128,400	84,700	10.75	33.0
5	"	"	781°	126,000	87,700	10.	33.4
6	"	"	755°	126,500	95,100	8.	39.0
7	"	"	724°	130,000	89,400	9.4	41.3
8	"	"	Ar 2-3 is 700° ± 695°	124,200	94,700	9.75	29.6
9	"	"	669°	129,100	98,050	8.75	27.3

ELASTIC LIMIT. — When steel is simply heated, as in annealing, to a high temperature, and then cooled slowly without undergoing mechanical work, the elastic limit varies in a most important way with the temperature from which the slow cooling occurs. As this temperature is progressively raised in a series of like samples, the elastic limit reaches a minimum at about Ac_1 or say 710° to 730° C., then rises, usually sharply, to a maximum at a

temperature usually but little higher, say between 750° and 850° , and then again decreases progressively. Turning to Fig. 79b, we find this true in four of the five series which give data covering this matter, and in the fifth we find the same law, with the exception that the depression at the minimum is much slighter than in the others (W. Mc. C $^{\circ}$.) A. Further, in the sixth series (W. Mc. C $^{\circ}$.) F., the data show a sharp maximum which corresponds very closely with that of the other investigations; and, while they do not positively prove the existence of the minimum at 750° , yet they certainly contain no suggestion that this minimum is here lacking. This agreement, which was wholly unlooked for, in these different series of results by three different investigators, goes far towards establishing this law.

Again, in Table 13, we find that, as the finishing temperature of a series of bars is progressively raised, the elastic limit behaves in a somewhat similar way, at least as regards reaching a distinct maximum decidedly above Ar_{2-3} . In the second series in which alone the data are full enough to detect a minimum, one is found, though not indeed a very marked one, at 724° C., *i. e.*, in the same temperature range as the minimum found in the Fig. 79b. I do not like to insist on this latter point because the evidence is so scanty. But at least we may say this, that there is nothing in the finishing temperature data inconsistent with the teachings of the T^{\max} data. Indeed, we can hardly expect that like variations in finishing temperature and in T^{\max} are to have exactly parallel effects.

We may therefore provisionally formulate law [10] as follows:

[10] As the temperature from which the slow undisturbed cooling of medium-carbon steel occurs, is progressively raised, the elastic limit of the cold steel falls to a minimum as this temperature reaches about 700° (Ac_1 ?), then it rises sharply to a maximum as the temperature rises slightly higher (say to 750° or 800° C.), and then again decreases progressively.

From the data here given we may also formulate law [11]:

[11] In general the slower the cooling the lower is the elastic limit.

It is wholly in accordance with law [10] that Mr. P. H. Dudley finds that rail steel with extremely fine structure (say 10,000 granulations to the square inch), though it is ductile and resists

Elastic Limit - (pounds per square inch)

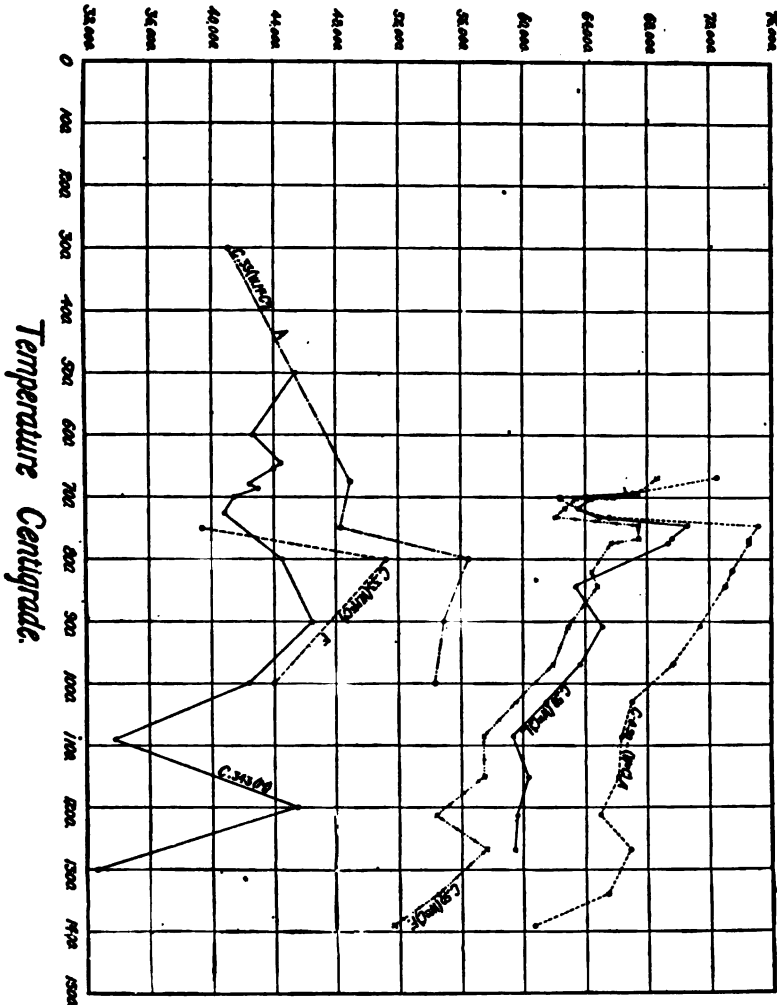

Fig. 79b. Influence of the Temperature from which Steel is Cooled Slowly, upon its Elastic Limit.

Note and Legend to Figs. 79b, 79c and 79d.

NOTE. — In each case the steel is supposed to have been heated to the temperature indicated, and then cooled slowly without undergoing any mechanical work.

Legend: C .33, C .50, etc. = 0.33, 0.50, etc., per cent Carbon.

(Au.) = The Author, *Trans. Am. Inst. Min. Eng.*, XXIII, pp. 527, 529, 531 and 532.

(Ba.) = E. J. Ball, *Journ. Iron and Steel Inst.*, 1890, I, Plate VI, Fig. III.

(B.) or (Bd.) = R. H. Bradford, from unpublished results reached in the Author's Laboratory.

(Wm. C.) = William Campbell, from results, to be published, reached in the Author's Laboratory.

(M.) = R. G. Morse, *Trans. Am. Inst. Min. Eng.*, XXIX, p. 745.

(W. M. Co.) = Westinghouse Mach. Co., *The Metallographist*, VI, April 1903, Frontispiece.

A = cooled in air. F = cooled in furnace. L = cooled in lime.

wear well, yet has too low an elastic limit. A rail should have three chief properties; ductility to insure power to resist the shock of the driving wheels, in order that it may not break; resistance to abrasion, that it may not wear out; and high limit of elasticity, that it may not take permanent set and be bent into a series of waves between its supporting ties, by the enormous pressures which the wheels of to-day throw upon it. According to Mr. Dudley's observations, and his opportunities and powers of observation are of the very best, rail steel of such composition as he likes (carbon 0.55 to 0.60 per cent, silicon 0.10 to 0.15, manganese 1.20, sulphur under 0.06, phosphorus under 0.06), should have somewhere between 5000 and 10,000 granulations to the square inch. If it has fewer, *i. e.*, if it is coarser grained, it is likely to be too brittle; if it has more, *i. e.*, if it is fine grained while it may be more ductile, yet its elastic limit will be too low.*

Our natural inference is that the low elastic limit which he finds in rails with extremely fine grain is due to a finishing temperature below that which, according to Fig. 79b, gives the maximum limit of elasticity.

This case is of interest as showing how important it is to check by large scale experiments and industrial tests the teachings of our laboratory investigations, and how each throws light upon the results of the other.

ELONGATION. — With 0.34 per cent of carbon or less we cannot readily detect any important and regular effect of the variations in the temperature from which slow cooling occurs as regards the elongation.

With 0.50 per cent of carbon (Wm. Campbell's data), as the temperature from which slow cooling occurs is progressively raised, the elongation of the cold steel decreases moderately until this temperature reaches about 1200° or 1300°; and the elongation decreases rapidly with farther rise of this temperature. The decrease is not very regular, and indeed for short distances turns into a decided increase; but this seems referable rather to individual peculiarities or observational errors than to any general law. I have here in mind particularly the fact that, for given ductility or true elongation, the observed elongation may vary very con-

* *The Metallographist*, VI, p. 111, and private communication, May 12, 1903.

Percentage of Elongation.

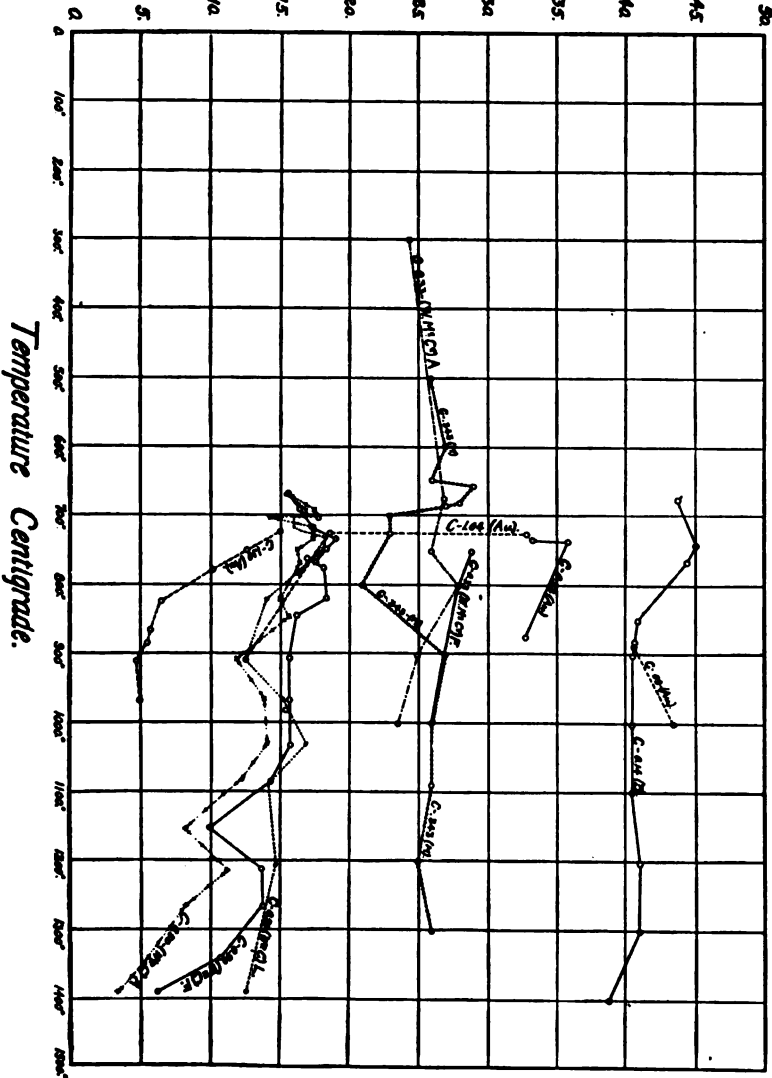

Fig. 79c. Influence of the Temperature from which Steel is Cooled Slowly, upon its Ductility.

(See Note and Legend, p. 271.)

siderably with the position in the length of the test piece where rupture occurs.

With 0.70 per cent of carbon (Table 12) the indications are much the same.

With hyper-eutectoid steel (4 cases by the author), the elongation falls off continuously and markedly with every rise of temperature from which slow cooling occurs. In two cases this decrease is much sharper about Ac_1 than at higher temperatures; the data in the other two cases do not indicate clearly whether the decrease varies in this way.

To sum this up, the effect of raising the temperature from which slow cooling occurs is, in general, to lessen the ductility as measured by the final elongation of the test pieces cut from the cold steel. This effect increases rapidly with the carbon-content, being relatively slight in case of steel of 0.34 per cent of carbon or less, but very great in case of hyper-eutectoid steel. There are indications of a general law that the decrease of elongation is especially marked as the temperature rises past Ac_1 , and again very marked as the temperature rises above 1300° .

This is in general accord with Prof. Sauveur's* early determination of the relation between the ductility and the grain-size of rail steel. He found that the elongation decreased as the grain-size increased; whence we infer that it decreased as the finishing temperature increased, or in other words that the influence of finishing temperature is like in kind to that of T^{\max} .

TENSILE STRENGTH. — In case of steel with less than 0.33 per cent of carbon the temperature from which slow cooling occurs appears to have little influence on the tensile strength, as far as the data here given show; but it is the general belief that if that temperature approaches the melting-point (probably if it enters region II of Fig. 68), the tensile strength decreases. The data here given do not cover this high range of temperature for such low-carbon steel.

In case of higher-carbon steel, the tensile strength at first increases as the temperature from which slow cooling occurs rises above Ac_1 to 800° , or even in cases to 900° or 1000° . Then, after varying somewhat, it falls off very abruptly in case of steel of 0.50 per cent of carbon, when that temperature approaches 1400° C.

* *Trans. Am. Institute Mining Engineers*, XXII, p. 556, 1893.

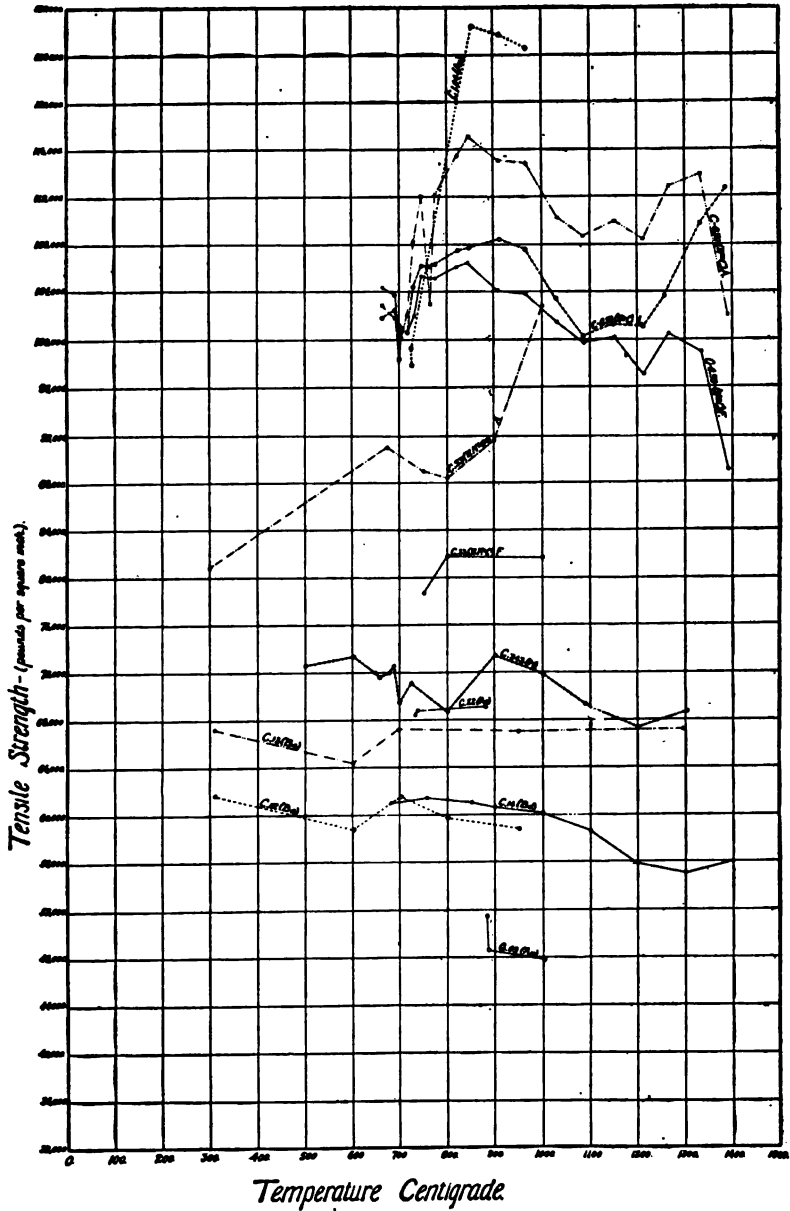

Fig. 79d. Influence of the Temperature from which Steel is Cooled Slowly, upon its Tensile Strength.

(See Note and Legend, p. 271.)

This precipitous decrease may correspond with the entry into region II of Fig. 68.

The fact that the increase of tensile strength when the temperature from which cooling occurs rises above A_{c1} , is very much more marked when the cooling occurs in the air than when it takes place still more slowly in the furnace itself, certainly suggests that even air cooling may be rapid enough to cause a certain degree of hardening proper by preventing the change from austenite into pearlite with ferrite or cementite from really completing itself.

While further investigation on this point is desirable, Dr. Campbell's series cooled in lime and in the furnace respectively show a material increase of tensile strength, too regular and consistent to be referred to experimental errors, and hardly to be referred to hardening proper.

Dr. Campbell's data in Table 13 do not indicate that finishing temperature has any marked influence on tensile strength, probably because his finishing temperatures were limited to the rather narrow range between 669° and 963° C.

This small influence of the temperature from which slow cooling occurs on tensile strength agrees with Prof. Sauveur's* early determinations of the relation between the grain-size and tensile strength of rail steel; although here, too, it is to be noted that the range of temperature represented is probably very narrow and that his data gave indications that, with a little higher finishing temperature, the tenacity increased, somewhat as is shown in Fig. 79d.

The Heat-treatment of Cast Iron.

220. THE HEAT-TREATMENT OF CAST IRON. — The reactions normal to the freezing range (1) to (6) inclusive, and those normal to the critical or transformation range (7) to (13) inclusive, suffice to explain the results obtained in the industrial heat-treatment of cast iron, if we remember that those of the critical range take an appreciable time, that those of the freezing range are completed only slowly, and that reaction (10), the transformation of graphite and austenite into cementite, is extremely slow. It is through playing upon the lag of these reactions, through

* *Loc. cit.*

permitting the several reactions to occur to the extent desired but no farther, that we vary the properties of cast iron by heat-treatment.

Let us now take up certain of these processes of heat-treatment, including among them the faster or slower initial cooling of the cast iron as it runs from the blast-furnace or the foundry cupola-furnace, yielding whiter and harder, or grayer and softer cast iron. Let us then consider (1) the chilling of cast iron in the process of making chilled castings, and (2) that of annealing those castings; and finally (3) the process of making malleable cast iron castings.

To fix our ideas, let us consider the case of cast iron containing 4.00 per cent of carbon.

221. THE REACTIONS WHICH SHOULD THEORETICALLY OCCUR IN FREEZING AND COOLING OF SUCH A CAST IRON. — It is not necessary to recapitulate these, because they have already been fully set forth. But, to present this and kindred matter in a condensed form to the eye I have prepared the tabular part of Fig. 68, arranging it so that it conforms with the several regions of that figure, as applied to a cast iron containing 4.00 per cent of carbon. In this table the reactions which are supposed to occur in the several regions are indicated in *italics*, and the constituents which are supposed to be present in each region are shown in CAPITALS.

The theoretical reactions in the freezing and cooling of such a cast iron are set forth in column 1.

There are three deviations (of which two are set forth in columns 2 and 3 of Fig. 68) from this theoretical set of reactions, which we may now consider. These deviations are as follows:

(1) that which we may call the formation of typical gray cast iron, the combined carbon of which is just the quantity (say 2 per cent) which suffices to saturate the austenite when in region VII;

(2) that which we may call the formation of typical white cast iron, in which all the carbon is combined (as cementite);

(3) and that which we may call the formation of typical ultra gray cast iron, in which all the carbon is in the state of graphite.

222. REACTIONS IN THE FREEZING AND COOLING OF TYPICAL GRAY CAST IRON. — By typical gray cast iron I refer to one in

which reaction (10), the transformation of graphite into cementite by reaction with austenite, is suppressed, but the other reactions take place in their entirety.

The result of this suppression is that the cast iron, when cold, contains in the form of cementite the carbon (assumed to be 2.00 per cent), which in region VII saturated the austenite, and as graphite the whole of the carbon which in region VII was present in the form of graphite, which by difference is also 2.00 per cent. In short, this cast iron when cold contains 2.00 per cent of combined carbon and 2.00 per cent of graphite.

The reactions, *etc.*, which, as we provisionally hold, occur in the cooling of such a cast iron, are set forth in column 2 of Fig. 68.

223. REACTIONS IN THE FREEZING AND COOLING OF TYPICAL WHITE CAST IRON. — By typical white cast iron I mean one in which the whole of the carbon is present in the combined state, *i. e.*, as cementite; and this we may assume provisionally is due to complete suppression of reaction (3), *i. e.*, the separation of graphite in the freezing of the molten eutectic, so that for reactions (2) and (3) jointly there is substituted reaction (14). In other words in region VII the metal consists of supersaturated austenite, instead of the normal eutectic conglomerate of graphite plus saturated austenite. The whole of the carbon, which in region VII exists as austenite is in further cooling changed into cementite. This, and indeed the whole course of matters, is indicated in column 3 of Fig. 68.

224. REACTIONS IN THE FREEZING AND COOLING OF TYPICAL ULTRA GRAY CAST IRON. — By typical ultra gray cast iron I refer to one in which the general course of events is the same as in the genesis of typical gray cast iron, with the important exception that owing to the presence of silicon or to some other cause, the transformation of graphite is greatly stimulated, so that the whole of the carbon in the cast iron when cold is found in the condition of graphite, and the iron then consists of ferrite plus graphite alone. The reactions in its freezing and cooling are not shown in the tabular part of Fig. 68.

Just what takes place in the cooling of such cast iron, or of a cast iron which approaches this type in containing when cold less combined carbon than would have saturated the austenite in region VII, can at present only be conjectured. One possible course

is that the austenite which freezes out as the temperature sinks through region II is quite carbonless in case of this typical ultra gray iron, and unsaturated in case of cast irons which approach this ultra type. In the further cooling of such iron, the conditions may be the same as those which we have supposed above for typical gray as distinguished from ultra gray cast iron. That is to say reaction (10), which ought to convert the graphite into cementite on cooling from region VII into region VIII, is suppressed, with the consequence that the whole of the graphite which was present in region VII is found in the cold cast iron.

In case of typical ultra gray iron, because the austenite is supposed to be quite carbonless, the normal reactions (II) and (8) by which austenite is normally changed into a conglomerate of pearlite and cementite, by definition cannot occur; and instead the austenite is simply transformed into ferrite.

In case of cast iron which approaches this type, we may suppose that these reactions (II) and (8) take place normally, with the result that the metal when cold consists of the graphite formed in freezing, plus as much cementite as suffices to represent the carbon present in the austenite in region VII. If that austenite contained less than 0.90 per cent of carbon, in short was hypo-eutectoid, then the cold cast iron should be a conglomerate of (1) graphite, and (2) pearlite with (3) free or "excess" ferrite. But if that austenite contained more than 0.90 per cent of carbon, *i. e.*, was hyper-eutectoid, then the conglomerate of which the cold cast iron should consist, should contain free or "excess" cementite instead of free ferrite.

225. THE CHILLING OF CAST IRON. — We have seen that in the freezing of a hypo-eutectic cast iron, first austenite, a solid solution of carbon in iron, freezes out, reaction (2), and second the eutectic (austenite plus graphite), freezes, reaction (3). We have further seen that the proportion of graphite which is actually found is the greater the slower the cooling, within limits; so that a sudden cooling appears to restrain the splitting up of the mother-metal into austenite plus graphite, leaving the austenite supersaturated with carbon, just as in the case of steel it prevents austenite from breaking up into pearlite. Thus sudden cooling retains in each case a supersaturated solution of carbon in iron, supersaturated austenite, which appears to follow the general rule that austenite is the harder the more carbon it contains.

Now we often purposely hasten the cooling of cast iron by casting it in cold iron moulds, a process known as "chilling," to distinguish it from the still more sudden cooling which quenching in water gives, as in the hardening of steel. Chilled cast iron is intensely hard and also very brittle. In this operation we probably get highly supersaturated austenite, first by restraining its tendency to resolve itself into graphite and saturated austenite at the eutectic freezing-point aBc , reaction (3), and second by preventing the austenite thus preserved from splitting up into pearlite plus cementite in crossing and leaving the transformation region VIII at Ar_1 , PSP' .

Much the same applies to hyper-eutectic cast iron; the sudden cooling should restrain both the separation of graphite in freezing, thus giving highly supersaturated austenite, and also the transformation of this austenite into pearlite and free cementite in crossing and leaving region VIII.

226. THE ANNEALING OF CHILLED CASTINGS. — Chilled castings unannealed are too brittle for many purposes, such as railroad car-wheels. They are annealed by heating them to a dull red heat, at which the supersaturated austenite splits up into pearlite plus cementite, *i. e.*, undergoes the transformation which it would have undergone in region VIII had the cooling been slow.

But even when thus annealed the chilled castings are white in fracture, and intensely hard. Why is this? Had the freezing been slow the austenite would have been only saturated, *i. e.*, would have contained only some 2 per cent of carbon, and the rest of the carbon would have existed as graphite. When such saturated austenite is resolved into pearlite in region VIII it yields only $2 \times \frac{100}{6.67} = 30$ per cent of cementite, together with 68 per cent of ferrite (together with the accompanying 2 per cent of graphite). But our supersaturated austenite, containing let us say 4 per cent of carbon dissolved in it, on splitting up in region VIII yields 60 per cent of cementite plus 40 of ferrite, in short twice as much cementite. Now, as cementite is intensely hard while ferrite is very soft, we have here a clear explanation of the greater hardness of chilled than of slowly cooled castings. And in the absence of graphite we have an explanation of the white fracture.

Were it possible to cool our molten cast iron extremely rapidly past regions II and VII, say to 800° in region VIII, and then

cool it slowly past Ar_1 , we should doubtless get approximately the hardness which we get in our chilled castings when they have been annealed. But in actual practice we split the operation up into two, a complete cooling (chilling) followed by reheating (annealing) as a matter of convenience.

Here as in case of steel, the annealing relieves the stress due to the initial sudden and hence unequal cooling.

Since it is only the tread of a car-wheel that needs hardness, so that it may resist wear, and since chilled, *i. e.*, white cast iron, is relatively brittle even after annealing, such objects are cast in moulds made partly of sand and partly of cold iron, so that the tread of the wheel is chilled and remains white and rich in cementite, while the rest of the wheel cools slowly and is not chilled, *i. e.*, is gray in fracture. We thus get the tread intensely hard because of its large proportion of cementite, but the "plate" or interior of the wheel is in the relatively ductile and safe state of gray cast iron, in which much of the cementite is replaced by a mechanical mixture of ferrite and graphite.

As this process is actually practiced, the chilled wheels are removed from their moulds when all but the very tread is still red-hot, and are then transferred to a pit in which they are allowed to cool down very slowly. The tread, in this operation, is reheated by the heat present in the body of the wheel when transferred to the annealing pit.

When very massive pieces of cast iron, such as large rolls, are chilled, no special annealing is required, because such castings, from their very size and shape, cool with sufficient slowness through VIII and the upper part of region IX to permit the austenite to resolve itself into pearlite and cementite. The rate of cooling is fast enough to restrain the very slow graphite-forming reaction (3), but is it not so fast as to arrest the transformation of austenite into pearlite and cementite, reactions (II) and (8).

227. MANUFACTURE OF MALLEABLE CASTINGS. — In the manufacture of malleable castings we use a white cast iron, *i. e.*, one which in solidifying at the usual relatively rapid rate generates within itself only very little graphite. It thus contains an abnormally great proportion of cementite. These white cast iron castings are then "annealed" by heating them for days to a temperature probably in region VII (say 1000°), so that the graphite, which would have separated in sufficiently slow freezing, has a chance to

form; and we remove part of this graphite by means of iron oxide in a bed of which these castings are heated. The reaction is of the following type:

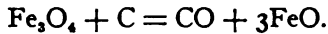

As the carbon at the very skin of the casting is thus removed, that within diffuses outwards to take its place. We may suppose that the actual diffusion is of the carbon in the solid-solution or austenite state; that this diffusion and the change of its carbon from the dissolved to the free or graphitic state occur side by side; and that it is this free graphite which is directly attacked by the iron oxide.

We may regard these castings as in effect a variety of gray cast iron, but with the special advantage over the common gray iron that the particles in which the graphite forms when the metal is thus reheated into region VII are extremely fine, and therefore much less injurious, less weakening and less embrittling, than the coarse flakes of graphite which form in regions II and III, in the freezing of the molten metal. The graphite generated in the solid metal in region VII has no opportunity of coalescing into flakes, as that does which is generated in the passage from the molten to the solid state; it remains as an impalpable powder.

Besides being less injurious, this finely divided graphite is also susceptible of being removed in considerable part, especially from the very outside of the casting, by surface oxidation, which is not the case with the coarse graphite flakes of common gray cast iron.

We may call this finely divided graphite "temper graphite," a modification of Ledebur's name "temper carbon."

These castings are relatively cheap like cast iron, not so much because the cost of conversion into steel is avoided, — indeed for this conversion has to be substituted the long annealing process by which the cementite is changed into temper graphite; — but because the lower melting-point of the metal as a whole greatly lessens the foundry expenses. At the same time these castings avoid the weakness and brittleness of white cast iron due to its great proportion of cementite, and they avoid the weakness and brittleness which the large size of the graphite flakes in common gray cast iron causes.

CHAPTER X.—THE PHASE RULE

228. IN GENERAL. — What is the Phase Rule? What is it about, and why is it of importance to metallurgists? The answer to these questions will be made easier by refreshing our memory on certain elementary matters.

We have seen that, just as crystalline rocks are composed of perfectly definite and distinct mineralogical entities called minerals, such as the mica, quartz and feldspar of a granite, so our alloys when solid are in general composed of similar definite entities, which correspond to the minerals of our crystalline rock. These entities, these minerals in one case and quasi-minerals in the other, are called "Phases," a term which will be more closely defined later. The phase rule has to do with these phases.

We have further seen that these microscopic constituents actually present in an alloy may or may not be those which should normally be present at the existing temperature. For instance we have seen that the constituents normal to slowly cooled steel are ferrite and cementite, partly free, partly mechanically mixed as the quasi-eutectic conglomerate called pearlite. We have further seen that, if the steel is cooled suddenly from above the critical range, instead of consisting when cold of these normal constituents, it actually consists chiefly of austenite. The austenite is not normal at this temperature; it exists normally only at temperatures in and above the critical range; but it may be preserved by sudden cooling; when so preserved it is abnormal, and in this sense the suddenly cooled steel is not in molecular equilibrium.

The phase rule is one which by superior analysis, and almost by inspection, helps us to answer such questions as (1) whether in any given alloy the constituents actually present are those which ought normally to be present, *i. e.*, whether the alloy is in molecular equilibrium in this sense; and (2) for any given transformation or change of state, what are the normal constituents which ought to result, *i. e.*, which correspond to equilibrium in this sense; and (3) many other related questions.

This it does essentially through telling us the "degree of liberty" of the alloy regarded as a system, *i. e.*, whether the ex-

isting constitution of the alloy has such a degree of stability that it can survive a change of temperature or of concentration, or cannot. Roughly speaking we may say that we find out what the "degree of liberty" is by comparing (1) the number of different "components" or "constituents," such as free metals (and metal-loids if any), present in any given alloy and also certain other entities, with (2) the number of "phases," *i. e.*, the number of distinct, and as it were mineralogical entities or distinct "minerals," or quasi-minerals, present in it.

For instance, pure carbon steel contains two components, iron and carbon. If hardened by sudden cooling it may be taken provisionally to consist of three distinct "minerals" or phases, the austenite which has been in large part preserved by the sudden cooling, unstable in the cold, tending to change back to ferrite and cementite; (2) a little ferrite and (3) a little cementite, both formed by the transformation of a little of the austenite in spite of the suddenness of the cooling. As a whole the molecular equilibrium is unstable; there is a residual tendency, and a powerful one though held in check, for the rest of the austenite to change back to ferrite and cementite. Here are two components, but those components are present in three distinct phases or conditions.

The ferrite and cementite of slowly cooled steel, on the other hand, are normal for the existing temperature and represent stable equilibrium. On slightly reheating slowly cooled steel, *i. e.*, annealed steel, its "system" undergoes no change, *i. e.*, it remains composed of ferrite and cementite. Here as before are two elements, iron and carbon, but these components exist in only two phases or conditions, ferrite and cementite.

The constitution or "system" of annealed steel, then, is evidently more stable than that of hardened steel, since it is not changed by this slight reheating, this change of condition; or in other words it can without itself changing survive this change of environing condition. In the language of the phase rule the former system has a greater "degree of liberty" than the latter. All this will be defined more precisely later.

Now we know it as a fact that the former system is more stable than the latter; but if it so happened that we were in ignorance of this, the phase rule would instruct us, without our having to make a direct experiment. And whereas we do happen to know it in the familiar case of steel, in many other like cases we should not

know by direct experiment which of such two states was the more stable, and indeed we might not know anything about the stability, absolute or relative, of the two systems. Here, too, the phase rule would stand us in like stead.

In the comparison between suddenly and slowly cooled steel, the phase rule bases its finding on the comparison between the numbers (1) two components but in three phases in the former, and (2) still two components but in only two phases in the latter. This too will be explained more fully beyond.

229. THE VALUE OF THE PHASE RULE to the metallurgist is chiefly as a guide for interpreting phenomena and planning investigations. When the investigator has before him a set of facts the explanation of which is not clear, he may on one hand proceed in ignorance, frame many conceivable theories by which these particular facts can be reconciled, and then proceed to test these different theories. The phase rule on the other hand may enable him to test them, and reject many or perhaps all of them immediately, by inspection and without making direct experiments; or it may immediately point out to him crucial tests which will enable him to decide quickly between two different theories.

Its present importance for students of alloys lies less in the present than in the prospective results of its application to this subject, in view of the present very active efforts of many investigators to apply it. This activity is so great that it would be hardly proper, even in a fragmentary work like the present, to pass the phase rule by without an attempt to outline its meaning.

Let us now look into certain of these matters a little farther, especially into the conditions of equilibrium and the terminology of the phase rule, before taking up that remarkable rule itself.

230. MEANING OF EQUILIBRIUM. — We have seen that, although most aqueous solutions and most molten alloys are simply homogeneous solutions, *e. g.*, of one metal in another, of carbon in iron, *etc.*, when they freeze they often split up into different distinct entities, such as (1) solid-solutions (silver in gold), or (2) pure metals (assumed to be true for lead and tin), or (3) pure metalloids (graphite in cast iron), or (4) definite chemical compounds (chloride of sodium, antimonide of copper, aluminide of gold). We have further seen that these molecular rearrangements take place not only in selective freezing, but also, as in case

of the iron-carbon compounds, through transformations in the solid but red-hot plastic mass. The molecular rearrangements of both classes, but more especially the sluggish transformations in the solid metal, often remain very far from complete when the metal has completely cooled, (1) because cooling at any common rate may not give the time which their completion requires, and (2) because, thanks to the slowness of diffusion, two constituents which would react on each other were they in actual contact, may be isolated from each other by a third constituent. Were there sufficient time for diffusion, these two constituents thus isolated would reach each other, react, and bring the system to molecular equilibrium. Once the metal is cold, what we may call molecular rigidity or molecular viscosity prevents these transformations; the cold like a brake, as it were, locks the atoms in their existing condition, abnormal for this range of temperature and in that sense unstable, striving to change to the molecular grouping normal at the existing temperature, but restrained by this molecular rigidity.

Thus even in relatively slowly cooled alloys equilibrium may be very imperfect, solid solutions remaining far supersaturated (§ 96, p. 113), and transformations being restrained. Of course rapid cooling, as in the hardening of steel (§ 198, p. 221), should leave the system still farther from equilibrium, so that there are strong residual unsatisfied tendencies to molecular regrouping, rearrangement, transformation.

If there are such unsatisfied tendencies pressing to assert themselves, such strained and eager springs, then on even slight reheating and consequent relaxation of the brake of molecular rigidity, the tendencies which have been resisted by the sudden cooling now reassert themselves, the restrained transformations go on, the atoms whose sluggishness held them in the wrong path now repent and return, and a certain degree of regrouping takes place.

231. AN EXAMPLE OF UNSTABLE EQUILIBRIUM. — Let the tempering of hardened steel illustrate this. This has already been discussed at length in § 204, p. 230, to which the reader is referred. To recapitulate the matter, above the critical range A_1 to A_3 , the metal spontaneously assumes the condition of austenite normal to that upper range; if it is cooled slowly below that critical range it changes spontaneously to the condition of ferrite and cementite

normal to this lower range of temperature.* If the steel is cooled rapidly from above the critical range to the room temperature, the change from austenite to ferrite and cementite is in large part arrested, so that most of the metal remains in the condition of austenite even in the cold, although this condition is not normal to this lower range of temperature. This is the *hardening* of steel.

If this hardened steel is now slightly reheated, even if this reheating carries it only up to 66° C., part of the unstable abnormal austenite changes towards the condition of ferrite and cementite: *i. e.*, the hardening is slightly mitigated, let down, or *tempered*; *i. e.*, the transformation which has been restrained by the rapid cooling now takes place to such degree as the slight reheating and the slight molecular relaxation which the reheating induces, permit.

Note particularly that the relaxation of the brake by such reheating is very slight, so that only a fraction of the restrained transformation occurs on such reheating.

To take up again the simile offered in § 206, p. 231 there is the bent spring of the restrained transformation still striving to complete itself, but restrained by the brake of the low temperature applied by the sudden cooling before the transformation had time to complete itself. Relax the brake slightly by slight reheating, and the spring can now begin to straighten itself; but in this very beginning of its own straightening, the spring loses a fraction of its tension, and this tension quickly falls to a point at which the present diminished grip of the brake suffices to master it, so that the spring moves no farther; equilibrium between spring and brake is reestablished, the restrained transformation goes no farther. Reheat it still farther, *i. e.*, relax the brake still more, the spring further straightens itself correspondingly, its tension falling correspondingly until it again becomes so light that the present friction of the brake again restrains it, and the transformation is again arrested.

Such is the state of affairs in a cold alloy if, regarded as a system, it is unstable.

* M. Osmond recognizes distinct stages of the transformation from austenite into ferrite and cementite and back, and calls metal in these stages *troostite* and *sorbite*. Without questioning the merits of this classification, we may here, for simplicity, treat of the transformation as if it were direct from austenite into pearlite and back. ("Contribution à l'Étude des Alliages," 1901, p. 370.)

232. STABLE EQUILIBRIUM. — If, on the other hand, the several tendencies towards molecular regrouping, towards transformation, have during slow cooling been fully complied with, so that the molecular constitution is normal for the existing temperature, and thus in stable equilibrium; then if the alloy or other system is reheated, no regrouping or transformation takes place, for the simple reason that there is no residual unfulfilled tendency towards regrouping.

233. BEHAVIOR ON REHEATING A CRITERION OF STABILITY. — This, then, is one criterion of stable equilibrium; if such equilibrium exists, reheating does not change the constitution; if not, it does. Conversely, if the constitution is changed by reheating, it was not in equilibrium; if it is not changed by reheating, it was in equilibrium.

This criterion must, of course, be applied with discretion and knowledge. For instance, if hardened steel is reheated to 320° , so that a certain degree of tempering, of change of austenite towards ferrite and cementite occurs, thanks to the increased molecular relaxation at this temperature; if it is then cooled to the room-temperature, and then again heated to 230° , no further change will take place. But yet we know that the metal is still chiefly composed of austenite, *i. e.*, that the equilibrium is still unstable. The fact that reheating to a temperature lower than that to which the quickly cooled metal has previously been reheated, induces no further change of constitution, is no evidence of stable equilibrium.

Conversely if steel is cooled so slowly that the transformation from austenite into pearlite with ferrite or cementite becomes complete, so that the cold metal is in stable molecular equilibrium, nevertheless its constitution will begin changing back to austenite when we reheat it to a critical temperature such as Ac_1 (approximately PSP' in Fig. 68). But this is no evidence that the system is unstable, as the least reflection shows. Water at 80° is stable, a stable system if we may call a single substance a system; the fact that if heated to 100° or cooled to 0° it ceases to be stable and is transformed into steam or ice, is no evidence to the contrary. When we say that it is stable, we refer to stability within the range of temperature in which the existing temperature lies. This range of temperature is bounded by critical points, for instance 0° and 100° in case of water. The range may be narrow or it may be

wide, and the existing temperature may be near or far from one or both boundaries of the range.

Thus if we are asking whether an existing system, as represented by some given alloy, is the system normal to the existing temperature and therefore in equilibrium, and if we seek to answer this question by noting whether on reheating that system undergoes change or not, — if we ask and seek thus, then the reheating which we perform (1) must be to a temperature higher than any which the alloy has reached since it entered its present range; and (2) it must not reach any critical temperature.

234. REVERSIBILITY AND LAG. — This leads us to the subject of reversibility.

The changes of state which occur during cooling are naturally reversed during a subsequent heating; and the same is true of the transformations unaccompanied by change of state which occur in cooling. For instance, if steam at atmospheric pressure is progressively cooled, it first condenses into water at 100° , and then this water freezes into ice at 0° ; if we now raise the temperature, this ice will again melt at 0° , and the resultant water will change into steam at 100° . The changes of state in cooling are exactly reversed in heating, and they are reversed habitually at the very temperatures at which they occurred in cooling; freezing and melting both occur at 0° , boiling and condensation both at 100° .

If we have steel of exactly 0.90 per cent of carbon and cool it from say 900° , on reaching a temperature of about 690° it changes from its initial condition of austenite into ferrite and cementite. If, after this transformation is complete, we reheat the steel, it changes back into austenite. But the temperature, Ar_1 , at which this transformation occurs in cooling is considerably lower than Ac_1 , the temperature at which it is reversed in heating; the transformation is reversed, but at a higher temperature. The fact that there is such a difference of temperature is a clear indication that the transformation in cooling did not occur promptly on reaching the theoretical temperature at which it should begin, and that something of the nature of surfusion took place during cooling. This inaccuracy of the reversing, then, is a first indication that during cooling the transformation lagged, and that during this time of lag the metal was in an abnormal state, one not of equilibrium.

Now if the changes which normally ought to occur in cooling actually do occur, so that the cooled alloy is in molecular equilibrium, then they are reversed on reheating. If, however, the tendencies towards any given change are not fully complied with during cooling, so that the cold alloy is not in molecular equilibrium, then the changes which occur on reheating are not the exact reverse of those which occurred in cooling.

We have steel containing 0.90 per cent of carbon; it has been cooled slowly; it consists of ferrite and cementite. We heat it past Ac_1 and it changes into austenite; we cool it below Ar_1 and it tends to change back to ferrite and cementite. There is thus the tendency on rising past the transformation-point to change from the normal low-temperature state (ferrite and cementite), to the normal high-temperature state (austenite); which change we may for brevity call the Low-to-High-Temperature-State Change, or the L-to-H change. Conversely, on cooling past the transformation-point there is the tendency to change from the normal high-temperature state of austenite to the normal low-temperature state of ferrite and cementite, or for brevity the H-to-L change.

235. HARDENED STEEL ILLUSTRATES IRREVERSIBILITY. — Suppose that this steel is above the transformation-point Ac_1 , and therefore is austenite; suppose we cool it so quickly that, of the H-to-L change which tends to occur as soon as the temperature sinks below Ar_1 , only a first instalment, only 10 per cent actually does occur, before the temperature has sunk too low to permit this change to proceed farther. Only 10 per cent of this change has occurred; the remainder, the complement, 90 per cent, is suppressed, *i. e.*, is arrested, but is still trying to occur. It is the spring of Fig. 71 restrained by the brake of low temperature.

We next relax the brake slightly by reheating to 230° as in tempering (so that a straw-colored film of oxide forms), and a second instalment of this suppressed complement, say a second 10 per cent, now occurs; so that all told 20 per cent of the H-to-L transformation has now occurred, and the complement, 80 per cent of it, still remains restrained by the brake. We then reheat still farther as in tempering at 300° , so that the film of oxide on the steel turns blue, and we thereby relax the brake farther; thereon a third instalment say an additional 15 per cent, of this H-to-L transformation occurs; so that now altogether 35 per cent of it has occurred. There is still a suppressed or restrained comple-

ment of 65 per cent striving to occur, but still prevented by the remaining grip of the brake. We next reheat still farther say to 600° , and we thereby remove the brake apparently completely, so that the 65 per cent complement which at 300° remained restrained, now occurs, and so that the whole of the H-to-L change takes place. The metal is annealed.

If, however, we finally carry the temperature a little higher, up above the transformation-point Ac_1 , the metal now changes from ferrite and cementite into austenite, in short the L-to-H change occurs.

Here, then, our actual transformations are as follows:

(1) in sudden cooling (hardening) from above Ar_1 , only 10 per cent of the H-to-L transformation occurs, and 90 per cent of it is restrained or suppressed. (10 per cent of the austenite changes into ferrite and cementite; the complement, 90 per cent, remains as austenite),

(2) in reheating,

(A) the remaining 90 per cent of the H-to-L change occurs as we reach first 230° (tempering straw), then 300° (tempering blue), and finally 600° (annealing). (The rest of the austenite changes into ferrite and cementite, so that at 600° the austenite has disappeared and the whole mass has changed into ferrite and cementite),

(B) when the temperature rises above Ac_1 the whole of the L-to-H transformation takes place (all the ferrite and all the cementite change back into austenite),

Or in short, in cooling, 10 per cent of the H-to-L transformation; in reheating

(A) 90 per cent of the H-to-L transformation, followed later

(B) by 100 per cent of the L-to-H transformation.

The transformations which here occur in heating clearly are very far from the exact reverse of those which occurred in cooling.

236. WHY IRREVERSIBILITY IMPLIES ABSENCE OF EQUILIBRIUM. — The reasons have really made themselves clear in this example. If cooling is too rapid to permit the H-to-L transformation to perfect itself, then the transformations which actually occur in such cooling are but an initial instalment of the normal ones, the complement of that instalment being suppressed by molecular rigidity. Now in order that the transformations which occur on reheating such rapidly cooled material should be the reverse of

those which have occurred in such a cooling, they should consist in simply reversing this initial instalment. But instead of this, what first occurs on reheating is the remainder, *i. e.*, suppressed complement of the H-to-L transformation, because heating relaxes the molecular rigidity which had suppressed or restrained that complement; and when the heating eventually reaches the transformation temperature, it is not an instalment but the whole of the H-to-L transformation which is now reversed, the initial 10 per cent instalment plus the suppressed complement.

Could the heating leap absolutely instantaneously back to the transformation temperature without consuming any time, at that temperature it would be only the initial instalment of H-to-L transformation which would be reversed, so that in this case the transformation in reheating would be the exact equivalent of that which occurred in the sudden cooling, or in other words there would be complete reversibility, although the suddenly cooled steel was certainly not in equilibrium. But such an instantaneous rise can never occur; it is indeed hardly thinkable; this rise from the cold to the transformation temperature must occupy a finite time, no matter how brief. Our heating must traverse the range between the room temperature and that transformation temperature, and what takes place in that range is the suppressed complement of the H-to-L transformation, and not simply a fraction of the reverse or L-to-H transformation.

Thus one criterion of whether the transformations normal to cooling have been completed, *i. e.*, of whether the cold alloy is in a state of molecular equilibrium, is that the series of transformations which it has undergone in cooling are exactly reversed in heating, or in short are *reversible*.

Thus, to say that the condition or molecular constitution of an alloy or other system reached through cooling is in molecular stability, and to say that the transformations through which it has passed are reversible, are synonymous. To say that the transformation temperatures during heating (*i. e.*, during rise of temperature), are higher than those during cooling is to say that there is lag and a period of molecular instability; to say that the transformation temperatures in heating and cooling are identical is to say that there is no such lag, and that the transformations in both heating and cooling occur promptly on reaching their normal temperature.

Terminology of the Phase Rule

237. COMPONENT AND PHASE. — The meaning of these two words must be clearly grasped. Let me attempt to define them, and to explain them by means of examples.

In the terminology of the phase rule, the "components" of an alloy or other system are the free elements and those compounds which in the nature of the case are undecomposable under the conditions contemplated, and so play the part of elements; those which enter directly into the equilibrium of the system. The components are the uncombined elements and compounds equivalent to elements in this sense. Lead and tin (elements), are the components of a lead-tin alloy, iron and carbon (elements), are those of steel, chloride of sodium and water (chemical compounds), are those of a salt-water solution.

The components may pass from one physical state (solid, liquid or gaseous) to another (water boils or freezes), and they may combine with each other and dissolve in each other in various ways, two components merging in each other in the form of a solution or compound (iron and carbon uniting to form cementite or austenite), or emerging thence into the free state (cementite splitting up into graphite and iron); and when they so merge, each of the compounds or solutions thereby formed tends to become homogeneous: it must become homogeneous before equilibrium can exist. Every such homogeneous compound or solution and every free element is a phase; and each of them is a distinct and different phase for every different physical state. Phases then are "the homogeneous states, whether of freedom, solution, or combination, and whether solid, liquid or gaseous, into which the components present pass or group themselves." The components are the entities in play, the entities of which we are studying the reciprocal behavior; the phases are the states, physical and chemical, in which these components exist, and into which they pass.

The usual definitions are, for phase "a mass chemically and physically homogeneous or a mass of uniform concentration, the number of phases in a system being the number of different homogeneous masses, or the number of masses of different concentrations:"* and for components "the substances of independently

* W. D. Bancroft, "The Phase Rule," p. 1, 1897.

variable concentration in the phase or system under consideration."* These definitions seem very exact; they may not, however, convey a very clear idea to an unwilling mind; good as tests, but not as explanations.

238. EXAMPLES OF COMPONENT AND PHASE, A. *The Components are Elements.* — Applying this to our metals and alloys, molten tin consists of a single component, tin, and a single phase, molten tin. If it cools to the freezing-point and begins freezing, different parts of the metal are simultaneously in two different phases, (1) molten tin and (2) solid tin; these are the two phases of the single component, tin. There is, strictly speaking, a third phase, the vapor of tin and usually the atmospheric oxygen and nitrogen; but we may simplify our whole discussion by ignoring the vapor in all cases, and suiting our formulas to this intentional omission.

In any lead-tin alloy (§ 48, p. 62), there are two components, lead and tin; if such an alloy of eutectic ratio is molten, and if the tin and lead are assumed to be wholly soluble in each other, so that the solution is homogeneous, there is one phase, this solution; when it begins to solidify and break up into the eutectic of plates of tin interstratified with those of lead, three phases are present, (1) the molten alloy, a molten solution and therefore a single as it were mineralogical entity, (2) the plates of solid lead, and (3) the plates of solid tin.

In a lead-zinc alloy (§ 98, p. 117), there are two components, these two metals. If a molten lead-zinc alloy is in such proportions that the two are not completely soluble in each other, but exist side by side as an emulsion, a mechanical mixture of two saturated solutions, (1) lead saturated with zinc, and (2) zinc saturated with lead, there are two phases, *viz.*, these two saturated solutions.

Again, in a pure steel consisting solely of iron and carbon, these two unchanging permanent elements are the two components, while the transient decomposable compound, cementite, and the equally transient solution, austenite, are phases, and so are the gaseous, molten and solid states. As the temperature rises past the critical or transformation range, past the melting-point, past the boiling-point, past the dissociation-point, and then descends

* W. D. Bancroft, "The Phase Rule," p. 1, 1897.

again, these two unchanging components, iron and carbon, enter into reciprocal play. They start as two phases free iron, ferrite, and iron carbide, cementite; on passing the critical range they pass from these phases into the solid-solution phase of austenite; when raised to the melting-point the austenite phase shifts into the phase of molten carburized iron (molten austenite, may we call it?). On reaching the boiling-point this phase shifts (let us assume for sake of example), to that of gaseous carburized iron; at the still higher dissociation-point this phase (let us again assume) shifts into that of free gaseous iron and free carbon. On recombining, recondensing, refreezing and retransformation, these phases are passed through in the reverse order. Ferrite and cementite, solid austenite, molten austenite (?), gaseous austenite (?), gaseous free iron and free carbon, these, let us assume, are the successive phases (some of them hypothetical), through which the unchanging components, iron and carbon, pass.

Here is a value of this word phase; it keeps us in face with the fact that we are regarding these systems as the resultants of some change from some other system; we regard a solid granite as resulting from state of fusion or at least from metamorphosis; we regard the constitution of a solid alloy habitually as resulting from the solidification of that alloy from its prior molten state. (See § 2, p. 2.)

239 B. EXAMPLES IN WHICH THE COMPONENTS ARE CHEMICAL COMPOUNDS. — We have thus far considered systems of which the components are elements; let us go a step farther and consider some in which the components are chemical compounds, playing the part of elements in that they are undecomposable under the conditions assumed.

A salt-water solution is frozen, and this ice is again melted; here the two components chloride of sodium and water start in the phase or condition of liquid solution; they then in freezing pass into the phases of solid chloride of sodium and solid water or ice; on remelting they pass back into the phase of liquid solution. Here the phases are three (1) the liquid salt-water solution, (2) solid salt, and (3) ice. But what are the components? Manifestly the water and the salt; it is they that, each remaining undecomposed, play back and forth between these different phases, quite as the uncombined elements tin and lead, lead and zinc, and iron and carbon, did in the cases which we have been studying. In the pres-

ent case it is clearly not the chlorine, the sodium, the hydrogen and the oxygen which are to be regarded as components. They do not directly enter into play; each is initially combined with another element, the chlorine with the sodium, and it is no longer free to act as chlorine; you can neither smell nor taste it. It is not directly between these elements, but between the water and salt that equilibrium exists; we are studying not the reciprocal behavior of these elements but of these compounds. Therefore these compounds, salt and water, are the components.

Or, to look at it in the language of the usual definition, the salt and water are "of independently variable concentration in the phase or system under consideration" in that we can vary the concentration of either of these independently of the other. We can add or remove water (by evaporation), and so shift the degree of concentration; but we cannot remove chlorine without removing the sodium with which it is combined, nor can we remove hydrogen without removing the oxygen with which it is combined. No one of these four elements can be removed from the system or added to it independently of the element with which it is combined, without changing the system into a wholly new and different one. To remove some of the sodium would change the system into a three component one, consisting of water, salt, and the free chlorine left by the removal of that sodium.

Again, in a typical granite composed of muscovite (potash) mica, quartz, orthoclase (potash) feldspar, we have (1) the three phases, each of these minerals being a phase, and (2) three components, silica, alumina and potash. It is true that there are four elements, silicon, aluminium, potassium and oxygen present, assuming that each of our minerals is quite pure. But for purposes of equilibrium we need not consider the number of elements; it is quite sufficient that, ignoring them, we concentrate our attention on the number of phases and of components, because in the nature of the case, in melting and refreezing our granite, in passing back and forth through different ranges of temperature, though these three components, these three oxides, may group themselves together in different ways, no one of them would be decomposed; as far as equilibrium is concerned they might as well be elements.

Again, when hydrated cupric sulphate is dissolved in water, then again crystallized out, then dehydrated, then again rehy-

drated and redissolved, the two unchanging entities are anhydrous cupric sulphate and water; it is these two that are the components; it is they that play back and forth through the phases of anhydrous salt, solid hydrated salt, and solution of different degrees of concentration. It is true that there are three chemical elements, copper, sulphur and oxygen; but this is beside the mark, for neither the cupric sulphate nor the water is liable to be decomposed through the changes of temperature contemplated. No one of these three elements enters directly and by itself into any reaction or change of state or of concentration, or into the equilibrium of the system; nor can either be varied independently of the others. That is to say, we cannot remove from the system part of its oxygen without simultaneously removing either the hydrogen or the copper and sulphur with which that oxygen is combined.

240. ALLOTROPIC MODIFICATIONS ARE DISTINCT PHASES. — Again, every distinct allotropic form of an element is a distinct phase. If graphite, diamond and amorphous carbon coexisted, they would constitute three distinct phases, because a mixture of different allotropic forms, and indeed of crystals of different forms, cannot be called “chemically and physically homogeneous.”

241. COMPOSITE EUTECTICS ARE NOT PHASES. — Although cold steel of 0.90 per cent of carbon, when slowly cooled, consists solely of pearlite, nevertheless it consists of two phases, *viz.*, the ferrite and cementite of which that pearlite is composed. As pearlite is not a mineralogical but a lithological entity, not homogeneous but heterogeneous, not a single substance but a mechanical mixture of two, it is not a phase at all, for mechanical mixing up does not constitute a phase. So although hypo-eutectoid steel when slowly cooled consists of pearlite plus ferrite, it contains only two phases, ferrite and cementite; for the fact that part of this ferrite is mechanically intermixed with the whole of the cementite in the form of pearlite does not affect the number of phases present.

242. HOMOGENEOUSNESS OF PHASES. — It has been said that every phase must be homogeneous; let us look at this matter further. Oil floating on water, or mixed up with the water as an emulsion typifies a di-phase system. A homogeneous solution of salt in water is a mono-phase system. But how about a heter-

ogeneous solution, either liquid, molten or solid? Is it a phase, or if not, what is it?

We may answer this in two ways. First the phase rule bears upon the question of equilibrium; but it is perfectly evident that no system can be in equilibrium which contains a heterogeneous solution, because there must exist in that solution an unfulfilled tendency to diffuse so as to efface that heterogeneity. Thus it is not necessary to resort to the phase rule to decide as to the equilibrium of such a system.

Second, in a heterogeneous solution there are in a sense an infinite number of phases, because every different degree of concentration represents a different phase. But, as we shall see, if we insist upon applying the phase rule to such a system, that rule shows it to be unstable.

243. PHYSICAL ACTIONS. — In a broad discussion of this subject it would be necessary to consider variations in both temperature and pressure. For our present purpose the whole discussion may be simplified by considering the pressure as constant, and the temperature alone as changing, and this will be done in the remainder of this chapter.

244. INDEPENDENTLY VARYING CONDITIONS. — In considering the equilibrium of a system, and the influence of changes of conditions on that equilibrium, there are two of these varying conditions which we must have in mind: varying temperature and varying degree of concentration of any solutions which are present, whether those solutions are solid on one hand, or liquid or molten on the other hand.

245. ARBITRARY AND CONFORMABLE VARIATIONS IN CONDITION. — Let us recognize that, when temperature and concentration vary, they may vary conformably with each other, or arbitrarily, *i. e.*, without regard to each other.

For example, in a beaker stands a solution of salt in water, at 20° , and just saturated for that temperature. We cool the mass to 10° , and the solution thereby becomes supersaturated, because the water has less solvent power for salt at 10° than at 20° ; accordingly the excess of salt crystallizes out, and a new equilibrium is thereby reached. But this has destroyed the mono-phase system, salt solution, and substituted for it a di-phase system, salt solution plus solid salt. This variation in temperature was arbitrary; there was nothing done to compensate for it.



Suppose, however, that when we cooled the mass to 10° we had simultaneously poured in enough pure water, also at 10° , to dilute the liquor to the saturation-point for 10° ; no salt would have crystallized out in this case, because we varied the second variable, concentration, conformably with the first, temperature. The system has survived the simultaneous changes in the two variables. In the first case the variation of temperature was arbitrary; but in the second instead of an arbitrary variation we had conformable variations of the two variables.

But if on cooling to 10° we had poured in half the quantity of water which we have just supposed, salt would still have crystallized out, because this smaller quantity of water would not suffice to prevent the supersaturation which the cooling tends to cause; in this case the variations in the two variables would be arbitrary instead of conformable.

246. DEGREE OF LIBERTY. THE PHASE RULE. — By the degree of liberty of a system we indicate whether that system can, without breaking up and becoming converted into some other system, survive an arbitrary variation in one of these two variables at a time, temperature and concentration; or in both of them simultaneously; or in neither of them. We are purposely ignoring variations in pressure, and also ignoring the vapor present, to simplify our discussion.

The degree of liberty is measured by the terms invariant or nonvariant, monovariant and divariant.

An invariant or nonvariant system is one which cannot survive a change either of temperature or concentration (*i. e.*, of either of our variable conditions), but breaks up and passes into some other system if either is changed; and this breaking up, due to a change of either of these conditions, cannot be prevented by any conformable change in the other condition.

A monovariant system is one which can survive a change of either temperature or concentration if accompanied by the conformable change in the other, but cannot survive simultaneous arbitrary changes in both temperature and concentration.

A divariant system is one which can survive simultaneous arbitrary changes in both temperature and concentration.

The degree of liberty of a nonvariant system is 0, that of a monovariant system 1, and of a divariant system 2.

We learn the degree of liberty of any given system, or in other words we learn whether it is nonvariant, monovariant or divariant, by the formula*

$$L = n + 1 - r,$$

in which

$$L = \text{the degree of liberty} \begin{cases} 0 & \text{for a nonvariant system} \\ 1 & \text{for a monovariant system} \\ 2 & \text{for a divariant system} \end{cases}$$

n = the number of components present, and

r = the number of phases present.

This formula is *the phase rule*.

A cold alloy if nonvariant is clearly unstable, since heating breaks it up; a cold monovariant alloy, on the other hand, is stable; and our stable alloys are characteristically of this type, though they pass through an nonvariant stage in freezing.

247. EXAMPLES TO TEST THE PHASE RULE. — Some examples which we will now take up will serve both to explain and to test the phase rule. Let us in each case first find what degree of liberty the phase rule assigns to the system under consideration; *i. e.*, whether the phase rule shows it to be nonvariant, monovariant or divariant; and if for instance the phase rule shows it

* This formula for the phase rule is based upon our purposely ignoring not only the gaseous phase always present, but also the variations in pressure. In a more general discussion these ought to be taken into account; and in that case the formula becomes

$$L = n + p - r,$$

in which p = the number of so-called physical actions, temperature and pressure. Here, as before, L is 0 for a nonvariant, 1 for a monovariant, and 2 for a divariant system; or, as is sometimes said:

a nonvariant system	has	$n + 2$	phases
a monovariant	"	"	$n + 1$
a divariant	"	"	n

In any given case the formula given in this footnote, and that given above in the text, lead to the same result. Thus, a mixture of ice and water is nonvariant by either formula; that it is nonvariant by the formula of the text $L = n + 1 - r$ is shown in § 249; that it is also nonvariant by the wider formula of this footnote is easily seen. The number of constituents is 1, water; the number of phases is 3, ice, water, and steam, — *i. e.*, the vapor of water floating above the mixed ice and water; the number of physical actions is 2, temperature and pressure. Hence, $L = 1 + 2 - 3 = 0$.

TABLE 14. — *Condensed Statement of the Examples Taken to Test the Phase Rule, §§ 247, to 254, inclusive.*

SYSTEM	ELEMENTS	COMPONENTS	PHASES	ENTITIES PRESENT WHICH ARE NOT PHASES	DEGREE OF LIBERTY
Freezing tin	Tin	Tin	Molten tin Solid tin		Nonvariant
Freezing water	H, O	Water	Liquid water Ice		Nonvariant
Salt water above the freezing-point	Na, Cl H, O	NaCl H ₂ O	Salt water (liquid solution)		Divariant
Salt ice	Na, Cl H, O	NaCl H ₂ O	Salt Ice	Eutectic of salt plus ice	Monovariant
Lead-tin alloy, molten	Sn, Pb	Sn, Pb	Mother-metal (molten solution)		Divariant
Lead-tin alloy, solid	Sn, Pb	Sn, Pb	Solid lead Solid tin	Eutectic of lead plus tin	Monovariant
Ditto during selective freezing	Sn, Pb	Sn, Pb	Solid lead Mother-metal (molten solution)		Monovariant
Ditto during eutectic freezing	Sn, Pb	Sn, Pb	Solid lead Solid tin Mother-metal (molten solution)	Eutectic of lead plus tin	Nonvariant
Molten steel of 0.50 per cent carbon	Fe, C	Fe, C	Molten solution		Divariant
Ditto at 1300°, solid	Fe, C	Fe, C	Solid solution (austenite)		Divariant
Ditto at 720°, S'' (Fig. 68)	Fe, C	Fe, C	(1) austenite (2) ferrite		Monovariant
Ditto at 690° hiv the recalescence	Fe, C	Fe, C	(1) austenite (2) ferrite (3) cementite	Pearlite (eutectoid of ferrite plus cementite)	Nonvariant
Ditto at the room-temperature, after quenching from above Ar ₁	Fe, C	Fe, C	(1) austenite (2) ferrite (3) cementite	Ditto in small quantity	Nonvariant
Ditto at the room-temperature when slowly cooled = annealed	Fe, C	Fe, C	(1) ferrite (2) cementite	Pearlite	Monovariant
Gray cast iron at the room-temperature*	Fe, C	Fe, C	(1) ferrite (2) cementite (3) graphite	Pearlite	Nonvariant
Chilled white cast iron	Fe, C	Fe, C	(1) ferrite (2) cementite (3) graphite (4) austenite	Pearlite	Nonvariant

to be monovariant, let us next examine the conditions of the case to see whether, judged from these, it really seems to be monovariant. Let us in short test the truth of the phase rule by an examination of several different systems.

For ease of reference, the elements, phases, components and degree of liberty of each of these cases are put together in condensed form in Table 14.

248. TIN IN THE ACT OF FREEZING, say at the stage represented by the point *C* in Fig. 14, p. 35. Here molten tin and solid tin are both present, and each of them is a distinct phase; so the equation becomes

Degree of Liberty = number of constituents + 1 — number of phases.

$$L = 1 + 1 - 2 = 0$$

so that the system is nonvariant.

Let us test this nonvariance. First, no change in composition is possible, since the chemical composition of the two phases is the same; the diffusion from one phase, the molten tin, into the other phase, solid tin, would leave the composition pure tin, *i. e.*, unaltered. Looking at it in another way, any change in composition would be a change from this system to another system; if the substance added dissolved in the tin, the system would be new, because a solid solution would be substituted for a pure metal; if it did not dissolve but remained apart, it would form an additional distinct and separate phase, and thus change the system from a di- to a tri-phase one.

The only change possible then is one in temperature. If we heat the system, some of the solid tin will melt, and the temperature will remain constant until the whole of the solid tin is melted; and during this constancy of temperature the system will remain unchanged, since a change in the proportions of the two different members of a system is not reckoned a change in the system; the phase rule is qualitative. But before we can actually raise the temperature above the melting-point, the whole of the solid tin must melt, *i. e.*, any actual elevation of temperature breaks up the system by completely removing one of its phases, solid tin, turning it from a di-phase into a mono-phase system.

In like manner if heat is abstracted, *e. g.*, by setting ice against the vessel which contains the freezing tin, the temperature

will remain constant until the molten part of the tin has all frozen, *i. e.*, no change in temperature will occur until the system breaks up by the complete removal of one of its phases, the molten tin, and so changes from a di-phase into a mono-phase system. In short, the system breaks up whenever the single variable condition, temperature, varies. It is therefore nonvariant; so that the phase rule proves to be true in this case.

249. WATER IN THE ACT OF FREEZING in like manner contains one constituent undecomposable under our conditions, in two phases, water and ice; so that $L = 1 + 1 - 2 = 0$, *i. e.*, the system is nonvariant, exactly as in the last case. No change in temperature can occur until either the whole of the ice or the whole of the water has been eliminated by changing into the other phase (all the ice melting and becoming water or all the water freezing and becoming ice), the system thereby changing from di-phase into mono-phase. The phase rule thus proves to be true in this case also.

250. SALT WATER ABOVE THE FREEZING-POINT. — There are two constituents, salt and water; there is one phase, a liquid solution; $L = 2 + 1 - 1 = 2$, the system is divariant. Now let us test this divariance.

Let us assume that the degree of concentration of the solution and the temperature are jointly represented by point *D*, Fig. 27, p. 58. Clearly the liquid solution will remain a liquid solution, *i. e.*, the system will remain mono-phase and unchanged if we lower the temperature arbitrarily to *f* without any change in composition, *e. g.*, by packing ice around the vessel which contains the solution; or if without changing the temperature we change the composition to *f'* by pouring in water; or if we simultaneously both dilute and cool the solution and bring its temperature and composition to *f''*. In short, the system remains mono-phase, *i. e.*, it is not broken up, even if both variable conditions, temperature and degree of concentration, are varied arbitrarily and each without reference to the simultaneous variation in the other. The system is therefore divariant.

251. SALT-ICE. — Assuming for simplicity as before that salt and frozen water are absolutely insoluble in each other, the salt ice say of composition and temperature *e* is a conglomerate of (1) the excess of pure ice above the eutectic ratio of 76.4 per cent water, 23.6 per cent salt and (2) the eutectic of interstratified

pure salt and pure ice. Here then are two constituents (salt and water), and two phases, (1) pure ice and (2) pure salt. $L = 2 + 1 - 2 = 1$, the system is monovariant. As before let us test this monovariance.

Here we need not enquire as to whether the system could survive a change in concentration simply because such change is unthinkable, on our present assumption that solid salt and ice are reciprocally absolutely insoluble. Hence the only variation to be considered is temperature. Clearly if the conglomerate of crystals of ice and other crystals of salt are heated (provided of course that the temperature does not reach the melting-point of the eutectic), no change will occur. The system is not split up on undergoing this variation, *i. e.*, it is monovariant.

What has been said of salt-water and salt-ice clearly applies to a molten and a solid lead-tin alloy.

252. LEAD-TIN ALLOY IN THE ACT OF SELECTIVE FREEZING. — To fix our ideas let us consider an alloy which, taken as a whole, contains 45 per cent of tin and 55 of lead; and let us suppose that, starting at 350° (point *G*, Fig. 24, p. 54), it has cooled to 212° (point *L'*), so that in cooling from *H* to *L'* selective freezing has been taking place.

In the freezing which has thus far occurred, crystals of the excess of lead have been born from the mother-metal, which has thereby been enriched in tin, until its composition at this instant is *M'*, or 56 per cent tin and 44 of lead, since at every instant during this selective freezing the composition of the mother-metal is normally that for which the existing temperature is the freezing-point.

Here are two constituents, lead and tin, two phases, solid lead and a molten solution containing 56 per cent of tin dissolved in 44 per cent of lead. The equation is $L = 2 + 1 - 2 = 1$. The system is monovariant. Let us test its monovariance.

The composition of the solid lead cannot vary, since we have for simplicity assumed that lead and tin are reciprocally completely insoluble; but the concentration of the molten solution of tin in lead can vary.

First let us see what happens if the temperature is lowered 12° to point *N'*. A little more lead will freeze out, the mother-metal will be enriched up to 60 per cent tin (point *Q*), but the phases will be the same as before, solid lead and a molten solution

of tin in lead; the system in short has not been broken up, for the change in concentration of a solution is not to be reckoned as a change in the system as such. In that the solution has this new degree of concentration it might indeed be called a new phase; but it is for our purpose the equivalent of the old one which it replaces.

But how about this same change in concentration; have not two conditions really varied, both temperature and composition, without breaking up the system; and is not the system therefore divariant in spite of the phase rule? Certainly not, for the change which has taken place in composition is simply that conformable with or corresponding to the change in temperature, and is not an arbitrary change. There has thus been but one arbitrary change.

Indeed it is this spontaneous shifting of concentration which has kept the system from breaking up and changing from (1) solid lead plus (2) molten solution of tin in lead, into the system (1) solid lead plus (2) solid tin, as we see on the slightest consideration. For, if by any device it could have been possible to prevent the change of concentration, so that when the temperature reached 200° the mother-metal still contained as it did at 212° , 56 per cent of tin and 44 of lead, that mother-metal would have frozen, since the temperature, 200° , is 12° below the freezing-point (212°) of such an alloy. A failure of the composition to shift conformably with the temperature would in effect be an arbitrary variation of the composition.

Thus far we have considered changes of temperature, and we have found the system monovariant, failing to break up if the temperature is changed, provided of course that the concentration shifts conformably, but breaking up if concentration does not so shift, *i. e.*, in effect shifts arbitrarily. Let us next take up the parallel case of changes in concentration.

Let us as before start with the system at 212° , consisting, therefore, of solid lead and a molten mother-metal of composition M' , with 56 per cent of tin and 44 of lead. Let us suppose that we shift the concentration of the molten mother-metal from M' to S , *e. g.*, by pouring into it enough of a molten alloy, also at 212° , and containing 70 per cent of tin and 30 of lead. If we simultaneously make the conformable change in temperature, *i. e.*, if we simultaneously lower the temperature from S to Q , from

212° to 200°, by external cooling, the system will remain unchanged; this is in fact what we did in the last case. But what will happen if we fail to change the temperature, and artificially change the concentration of the mother-metal by pouring it off and substituting another lot of molten metal at 212°?

Such molten metal at this temperature manifestly could not have more than the 44 per cent of lead contained in the mother-metal just poured off, because the existing temperature, 212°, is below the melting-point of any lead-tin alloy with more than 44 per cent of lead. So if any alloy with more than 44 per cent of lead were added, it would have to be solid, and being solid would consist of plates of lead interstratified with plates of tin; so that the system as a whole would be (1) solid lead, including that formed in the original cooling to 212° plus that in the alloy now added; plus (2) solid tin. This resultant system would be a wholly different one from what we are aiming to create, *viz.*, (1) solid lead plus (2) a molten solution of less than 56 per cent of tin in more than 44 per cent of lead.

As it is thus impossible to shift the concentration of the molten phase in the direction of greater richness in lead, let us try shifting it in the opposite direction of greater richness in tin; and let us suppose that we do this by pouring off our present 44 per cent mother-metal and substituting for it a new lot of molten alloy of composition *R*, 65 per cent tin. It is evident that our solid lead would immediately begin melting and entering this molten metal and would continue melting because, so long as the reëtrance of the lead into it did not reduce its percentage of tin below 56 per cent, the molten metal would remain molten. We have seen (§ 21, p. 26), that this is the general condition which determines whether a solid metal shall melt and enter into a molten metal with which it is in contact. If the alloy which its entrance into that molten metal would form would be so fusible that it would remain molten at the existing temperature, the solid metal would so melt and enter the molten one.

But suppose we now try again, and pour off this new molten metal, and add a third lot of molten alloy of 65 per cent of tin and 35 lead, like the last; this will in the same way dissolve more of our lead, and will keep dissolving it until the tin-content of the molten part shall have fallen to 56 per cent. So our steps to keep in contact with our solid lead at this temperature, a molten

metal with more than 56 per cent of tin, do not at first succeed; manifestly no matter how many times we replace the molten metal with new, its tin-content will always sink down to 56 per cent by taking up some of the originally solid lead, until the whole of the solid lead shall thus have been melted away; in short until our system shall have been broken up by the vanishing of one of its members, the solid lead.

Clearly the same result would follow if, instead of pouring off our mother-metal and replacing it by a new lot, we were to enrich it in tin, at constant temperature, by pouring into it a lot of molten alloy containing say 80 per cent tin and 20 per cent lead, initially at this same temperature 212° .

In short, the system cannot survive a shifting of the degree of concentration of the molten metal, unless it is accompanied by a conformable shifting of the temperature; for such shifting in the direction of greater richness in lead leads to a new di-phase system, solid lead plus solid tin, while in the direction of greater richness in tin it leads to a new and mono-phase system, molten solution of tin in lead. This result is wholly in accordance with the phase rule, since a shifting of concentration unaccompanied by the corresponding shifting of temperature is in effect an arbitrary shifting of both concentration and temperature, which, as the phase rule teaches, a monovariant system cannot survive.

Thus in every respect our system satisfies our tests of its monovariance.

253. THE SAME LEAD-TIN ALLOY (COMPOSITION *G*), AT THE FREEZING-POINT OF THE EUTECTIC, SAY AT *J*, FIG. 24. — Let us suppose that the whole of the excess of lead has frozen out, so that the mother-metal has been enriched to its eutectic ratio, *B*, of 69 per cent tin, 31 per cent lead; and that part of this eutectic mother-metal has frozen, while part still remains unfrozen.

The phases will be (1) solid lead, including (*A*) the excess over the eutectic ratio, frozen out between *H* and *J*, and (*B*) the plates of lead contained in the already frozen part of the eutectic; plus (2) solid tin, in the frozen part of the eutectic; plus (3) a molten solution of tin in lead, the still unfrozen part of the eutectic mother-metal. Three phases, and as before two constituents, lead and tin.

The equation becomes $L = 2 + 1 - 3 = 0$, *i. e.*, the system is nonvariant. Let us as before test this nonvariance.

The possible variations are (1) rise and (2) fall of temperature; (3) enrichment and (4) impoverishment in tin of the still molten mother-metal. Let us test these variations separately; if the system is truly nonvariant, any one of them should break it up.

(1) Rise of temperature. If we apply heat, the now frozen part of the eutectic will begin to melt, and the temperature will remain constant until the whole of it has melted; then only will the temperature begin to rise. But this complete melting of the eutectic will remove the whole of our solid tin. In short a rise of temperature can occur only after the system has broken up through the elimination of this second phase, solid tin; or in other words the system cannot survive a rise of temperature.

(2) Fall of temperature. In like manner, if we abstract heat by external cooling, the still molten part of the eutectic mother-metal will begin freezing, and the temperature will remain constant until the whole of it has frozen, *i. e.*, until the molten phase of the system has been eliminated; only then will the temperature fall below its initial point of 180° . In short, a fall of temperature can occur only after the system has broken up through the elimination of its third phase, molten solution of tin in lead; or in other words the system cannot survive a fall of temperature.

We saw that in the range of selective freezing, at L' , Fig. 24 (as distinguished from the present eutectic freezing), either a rise or fall of temperature could be survived provided that the concentration of the molten phase shifted correspondingly. Here, however, the system could not be saved by any such device, for any rise of temperature would remelt the now solid part of the eutectic, thus eliminating our second phase, solid tin, no matter what the composition of the adjacent molten phase. Further, any fall of temperature would eliminate our third phase, the molten solution or mother-metal, no matter what its composition; because no lead-tin alloy can remain molten below our initial temperature of 180° , for it is the freezing-point of the most fusible lead-tin alloy. Thus any fall of temperature must substitute a solid lead-tin alloy for our molten phase; but this would break up our system, changing it from a tri-phase to a di-phase one, consisting of (1) solid lead and (2) solid tin, since every solid lead-tin alloy must be a mixture of plates of lead and

other plates of tin, thanks to the assumed complete insolubility of these two metals in each other when solid.

Here again, no shifting of concentration can enable our system to survive any change of temperature, for any rise of temperature must eliminate the solid tin phase, and any fall of temperature the molten solution phase.

(3) Enrichment and (4) impoverishment of the molten mother-metal in tin. As the temperature is now by assumption at the freezing-point of the eutectic, and as this is the most fusible lead-tin alloy, the temperature is below the freezing-point of every other lead-tin alloy. Consequently it would be impossible to substitute for this molten phase any other molten alloy either richer or poorer in tin, because no such other alloy could be molten at this temperature. Any alloy either richer or poorer thus substituted would at this temperature be solid; and because solid it would be a mechanical mixture of plates of solid lead and other plates of solid tin, these two metals having been assumed for simplicity to be absolutely insoluble in each other when solid. But our system would then be (1) solid lead, including both (A) the excess of lead over the eutectic ratio frozen out between *H* and *J*, and (B) the solid lead in the new solid alloy now added; plus (2) the solid tin in this newly added alloy. In short it would be a new and di-phase system, instead of our original tri-phase system, for the third of our original phases, the molten solution of tin in lead, would have been eliminated. In short our system cannot survive either enrichment or impoverishment of the molten phase in tin.

We have thus found that the system cannot survive any of the four possible changes in temperature or concentration; so that it satisfies all our tests of its complete nonvariance.

254. THE IRON-CARBON COMPOUNDS.—To take a simple series of cases, let us select steel containing 0.50 per cent of carbon, *Sh^v* of Fig. 68 at six different temperatures, 1600° *S*, 1500°, 1300° *S'*, 720° *S''*, 690° *h^v* and 0° *h^v*, representing (1) the molten condition, (2) the state of selective freezing, (3) the austenite state, (4) the separation of ferrite just above the recalescence, (5) the recalescence, and (6) the common or room-temperature state. This latter case we will subdivide into two, those of (A) hardened (suddenly cooled) and (B) unhardened (slowly cooled) steel respectively.

There will in every case be two constituents, carbon and iron; the system will be nonvariant if there are three phases, monovariant if there are two, divariant if there is only one.

(1) At $1600^{\circ} S$, there is one phase, molten carburized iron; the system is divariant.

(2) At 1500° during selective freezing, there are two phases, molten carburized iron and solid austenite. The system is monovariant.

(3) At $1300^{\circ} S'$, there is only one phase, austenite. The system is divariant.

(4) At $720^{\circ} S''$ there are two phases, (1) the free iron which has already separated out within the plastic redhot mass as ferrite, between h''' and S'' ; and (2) the residual austenite from which it has separated, and within which it is still enclosed. The system is monovariant.

(5) At $690^{\circ} h^{IV}$, the recalescence, there are three phases, ferrite and cementite (partly interstratified in the form of pearlite), which have already resulted from the decomposition of the austenite, and the residual austenite which has not yet split up into ferrite and cementite. The system is nonvariant.

(6A) At the room-temperature, h^V , if the decomposition of the austenite has been complete, so that only pearlite with ferrite as the excess substance remains, there are only two phases, ferrite and cementite; the system is monovariant; it is in equilibrium; it is not affected by reheating, *e. g.*, to 300° .

(6B) At the room-temperature, h^V , if the steel has been hardened by a cooling so sudden that part of the austenite has failed to decompose into ferrite and cementite, then there are three phases, this residual austenite plus such ferrite and cementite as have resulted from such decomposition of austenite as has occurred in spite of the suddenness of the cooling. The system is nonvariant; it is not in equilibrium; when reheated to 200° as in tempering more of the austenite changes into ferrite and cementite.

The reasoning already given in §§ 248 to 253, pp. 302 to 309, suffices to explain these several cases.

255. THE PHASE RULE APPLIES ONLY TO SYSTEMS PROPERLY SO CALLED. — The unthinking might be puzzled by trying to apply the phase rule to cases to which it is manifestly inapplicable,

to cases which are not systems at all in the sense of the phase rule.

Thus some might reason as follows: "I place a lump of cold sulphur upon a lump of cold iron. Two components, sulphur and iron; two phases, sulphur and iron. Degree of liberty = $n + 1 - r = 2 + 1 - 2 = 1$; hence this is a monovariant system; hence if sulphur and iron are heated they will not react upon each other according to the phase rule. But I happen to know that they will react; hence the phase rule is wrong and misleading."

The answer is that such a mass is not a system at all. The sulphur and iron are not phases into which some prior system has passed. Let the case of the ferrite and cementite illustrate this. While these substances in slowly cooled steel, resulting from the decomposition of the austenite of which the steel consisted when it was above the transformation temperature, form a system, which is di-phase; yet if we were to isolate certain particles of this pure cementite and certain other particles of pure ferrite and shake them up together while cold, this would not constitute a system. The phase rule has nothing to say of such a mass.

Thus if it were true that when molten iron sulphide cooled it resolved itself into separate particles of free sulphur and free iron, then we should justly infer that the system was monovariant, *i. e.* that the sulphur and iron would not recombine on heating.

256. THE PHASE RULE IN ONE ASPECT IS QUALITATIVE, NOT QUANTITATIVE. — While it is true that the phase rule is quantitative as regards the number of components and phases, yet it has nothing to do with the quantity of any of those components or phases, and in this sense is qualitative. Let the case of the lead-tin alloy during selective freezing (§ 252, p. 304) illustrate this. When selective freezing has just begun; when the lead already frozen out amounts to say 1 per cent by weight of the whole alloy, the two phases are:

- (1) solid lead, forming 1 per cent of the whole,
- (2) molten lead-tin alloy forming 99 per cent of the whole.

As the freezing progresses, the solid lead forms a continuously increasing proportion of the whole, and the remaining molten mother-metal a continuously decreasing percentage of the whole; yet the two remain always in equilibrium, and remain one and the same system.

Indeed, the least reflection shows that equilibrium — and it is with equilibrium that the phase rule has to do — is a purely qualitative thing, and has no relation to quantity. Let a simple example verify this idea.

In a large chamber *F, G, H, K* (Fig. 80) is placed a steam boiler *B*, with which are connected a mud-drum *C* and a steam-drum *A*. The boiler is filled with water to about level *L*, and, an escape valve being open from *A* into the open air, the temperature of *F, G, H, K* is raised to 100°C . (212°F). The water boils until all air is expelled. Then this exit valve is closed, so that the system *A, B, C*, is isolated from without, in short so that no steam can escape and no water can be fed in; but the valves

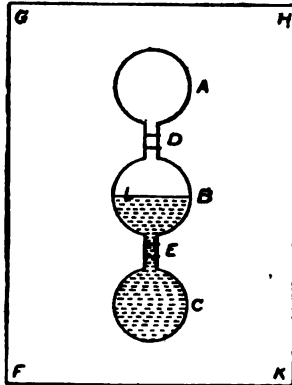

Fig. 80. Equilibrium is not Quantitative but Qualitative.

D and *E* are open, so that the boiler and its drums are in free communication with each other. The temperature is raised to say 121.4°C . (250.5°F), and the water in *B* evaporates until the pressure of steam (its vapor tension) in the upper part of *B* and in *A* reaches 2 atmospheres (29.5 pounds per square inch). At this pressure and temperature the steam and water are in equilibrium with each other. The further evaporation of water is just balanced by the simultaneous condensation of steam, so that to the eye neither evaporation nor condensation appears to take place.

Now this equilibrium has nothing to do with the quantity of water and steam, or with the proportion between the two, as

is readily seen. Assume that temperature and pressure remaining constant, we close valve *E*; manifestly this will not induce either further evaporation or further condensation; it will have no effect whatsoever. Suppose that now, holding this valve closed, we disconnect this mud-drum *C* and remove it altogether to the outside and destroy it. The quantity of water remaining in the system will be only about one-third as great as originally, while the quantity of steam remains unchanged; the ratio between the quantity of water and of steam has changed greatly, but this change has not in the least affected the equilibrium.

The same would be true if, closing valve *D*, we had removed the steam in the steam-drum *A* from the system; and also if, holding the temperature and pressure constant, we had replaced and reconnected the steam or the mud-drum, or both of them, reopening either or both valves *D* and *E*. Thus we see that no matter what change we bring about in the quantities of water and steam, this change does not affect the equilibrium, provided that temperature and pressure remain constant.

CHAPTER XI.—PROGRESS IN THE MANUFACTURE OF IRON AND STEEL, BETWEEN 1880 AND 1900*

257. SUMMARY. — In the last twenty years of the nineteenth century the world's production of pig iron more than doubled, and that of steel increased fivefold, while that of wrought iron became of secondary importance. The United States passed from the position of the second to that of by far the greatest producer of both pig iron and steel; their production of the former more than tripled, becoming 54 per cent greater than that of Great Britain, and their production of steel increased to more than eight times that of 1880, becoming more than double that of Great Britain,

* Most of this chapter appeared in 1902 as the article on Iron and Steel in the supplement to the *Encyclopædia Britannica* published by the London *Times*. To fit it somewhat to the present work, parts have been omitted, others expanded, still others added, and some of the statistical data have been replaced by later ones.

The Author's sincere thanks are due to the *Times* for permission to reproduce this matter here.

56 per cent greater than that of Germany and Luxemburg together, and 38 per cent of the total for the whole world. In this period the basic open-hearth and basic Bessemer processes rose from mere beginnings to vast importance, each of them now producing in these, the three great iron-making countries, about as much steel as the whole world made in 1880. Of the total production of steel in these three countries in 1899, some 43 per cent was made by the acid Bessemer process, 20 per cent by the basic Bessemer, 16 per cent by the acid open-hearth, 18 per cent by the basic open-hearth — the process in which the greatest development is now to be expected — and only about 1 per cent by the crucible and other minor processes. The production of wrought iron in the United States, which in 1880 was 67 per cent greater than that of steel, is now only about one-sixth that of steel, and wrought iron has practically gone out of use for important objects like rails, and the beams, angles, and other chief parts of bridges and iron buildings, though it will probably long be used for special purposes for which great ease of welding or special ductility is needed.

Delicate methods of research have revealed the nature and constitution of the several varieties of iron. This knowledge has contributed in no small degree to the important beginning which has been made in the use of rational methods of thermal treatment, in which a great extension is to be expected, and it has aided in the discovery and utilization of numerous "alloy" steels.

For armor plate not only has steel completely displaced wrought iron, but alloy steel, which has been specially and differentially carburized, and has received a special heat-treatment, has come into general use. Much the same is true of many other important objects for which the highest quality is needed; thus all armor-piercing projectiles, and many important forgings for engines, especially marine engines, are made of like materials.

Throughout the manufacture of iron and steel those twenty years witnessed great simplification, extension of the use of mechanical appliances, and, especially in the manufacture of the relatively simple products, such as rails, wire, sheets, tubing, beams, etc., a concentration of the industry into enormous establishments, operating on so large a scale as to warrant the use of powerful and costly labor-saving machinery, and the employment

of many highly trained specialists to investigate and watch with the utmost care even the slightest details. In the last ten years of the 19th century alone the cost of labor in many important process was reduced by about one-half, without reducing the rate of wages.

Processes for obtaining wrought iron and steel "direct" from the ore lost their immediate, though not wholly their prospective importance, and at the present time nearly all the ore which is mined is converted into pig iron in the iron blast-furnace. Chiefly by daring, and by the use of more powerful blowing-engines and hot-blast stoves, and of better arrangements for cooling and so protecting the lower part of the furnace, the production of the blast-furnace was increased, until the average production of a single Carnegie furnace to-day, some 200,000 tons per annum, is greater than that of all the United States furnaces in 1830, and ten times that of 1820, and is one-fourth that of the whole world in 1800. By using the waste gases of the blast-furnace in gas engines their importance as sources of power has been greatly increased, so that establishments in which the rolling-mills and other machinery adjoin the blast-furnaces, and therefore can be driven by such engines, will be given a new and often an irresistible advantage over their competitors.

The use of great "mixers" to lessen the irregularities in the composition of the pig iron as it issues from the blast-furnace, enables the Bessemer process to be applied directly to that iron, without allowing it to solidify and thus to dissipate its heat; and this same procedure has come into wide use for the open-hearth process and has even been used tentatively for the puddling process.

The capacity of a single Bessemer converter is now as much as 20 tons, and that of the open-hearth furnace 70 tons, and owing to the car-casting system and other improvements the production of a single pair of Bessemer converters has reached 65,872 tons per month — a rate sixty times that of 1870, and more than four times that of 1880. In some Bessemer works not only is the iron never allowed to cool between its entry into the blast-furnace in the state of ore, and its delivery from the rolling-mill in the form of rails or even of billets, but in this progress it undergoes no true heating by extraneous fuel, save in the blast-furnace itself, for the pig iron furnishes its own calorific power in the

Bessemer converter, and the only other furnace treatment, that of "soaking," merely equalizes the heat of the ingot, and prevents its escape without adding to it.

258. ALLOY STEELS have come into extensive use for important special purposes, and a very great increase of their use is to be expected. The chief ones are nickel steel, manganese steel, chrome steel, molybdenum steel, and tungsten steel. The general order of merit of a given variety or specimen of iron or steel may be measured by the degree to which it combines strength and hardness with ductility. These two classes of properties tend to exclude each other, for, as a general rule, whatever tends to make iron and steel hard and strong, tends to make it correspondingly brittle, and hence liable to break treacherously, especially under shock. Manganese steel and nickel steel form an important exception to this rule, in being at once very strong and hard, and extremely ductile.

259. NICKEL STEEL, which usually contains from 3 to 3.50 per cent of nickel and about 0.25 per cent of carbon, combines very great tensile strength and hardness, and a very high limit of elasticity, with great ductility. Its combination of ductility with strength and hardness has given it very extended use for the armor of war-vessels. For instance, following Krupp's formula, the side and barbette armor of war-vessels is now generally if not universally made of nickel steel containing about 3.25 per cent of nickel, 0.25 per cent of carbon, and 1.50 per cent of chromium, and is deeply carburized on its impact face. Here the merit of nickel steel is not so much that it resists perforation, as that it does not crack even when deeply penetrated by a projectile.

The combination of ductility, which lessens the tendency to break when overstrained or distorted, with a very high limit of elasticity, gives it great value for shafting, the merit of which is measured by its endurance of the repeated stresses to which its rotation exposes it whenever its alignment is not mathematically straight. The alignment of marine shafting, changing with every passing wave, is an extreme example. Such an intermittently applied stress is far more destructive to iron than a continuous one, and even if it is only half that of the limit of elasticity, its indefinite repetition eventually causes rupture. In a direct comparative test the presence of 3.25 per cent of nickel increased nearly

sixfold the number of rotations which a steel shaft would endure before breaking.

Nickel steel has been used tentatively for railroad rails; but while it has the stiffness and resistance to wear which they require, too many rails have broken in use. We may hope that this treacherousness will be prevented.

Figs. 81 and 82 give the tensile strength and the ductility of many specimens of nickel steel from various sources, chiefly, however, from M. Dumas' important monograph.* The curves here given are taken from his work (pp. 18 and 19). A rough resemblance to the manganese steel curves (Figs. 83 and 84) may be noticed. The great increase of ductility in case of manganese steel in the 13 per cent manganese region, is reflected in case of nickel steel by a like and very abrupt rise at about 25 per cent of nickel. Again, as the high-ductility region in case of manganese steel is also a region of high tensile strength, so is it also in case of nickel steel.

260. MANGANESE STEEL. — As actually made, manganese steel contains about 12 per cent of manganese and 1.50 per cent of carbon. Although the presence of 1.50 per cent of manganese makes steel brittle, and although a further addition at first increases this brittleness, so that steel containing between 4 and 5.5 per cent can be pulverized under the hammer, yet a still further increase gives very great ductility, accompanied by great hardness — a combination of properties which, so far as I know, was not possessed by any other known substance when this remarkable alloy, known as Hadfield's manganese steel, was discovered.

Its ductility, to which it owes much of its value, is profoundly affected by the rate of cooling. Sudden cooling makes the metal extremely ductile, and slow cooling makes it brittle; its behaviour in this respect is thus the opposite of that of carbon steel. Its great hardness, however, is not materially affected by the rate of cooling.

It is used extensively for objects which require both hardness and ductility, such as rock-crushing machinery, railway crossings, mine-car wheels, and safes. The burglar with his blow-pipe "draws the temper," *i. e.*, softens a spot on a hardened carbon steel or chrome steel safe by simply heating it, so that as soon as

* "Recherches sur les Aciers au Nickel à Hautes Teneurs," M. L. Dumas, Paris, 1902.

Tensile Strength - Pounds per square inch.

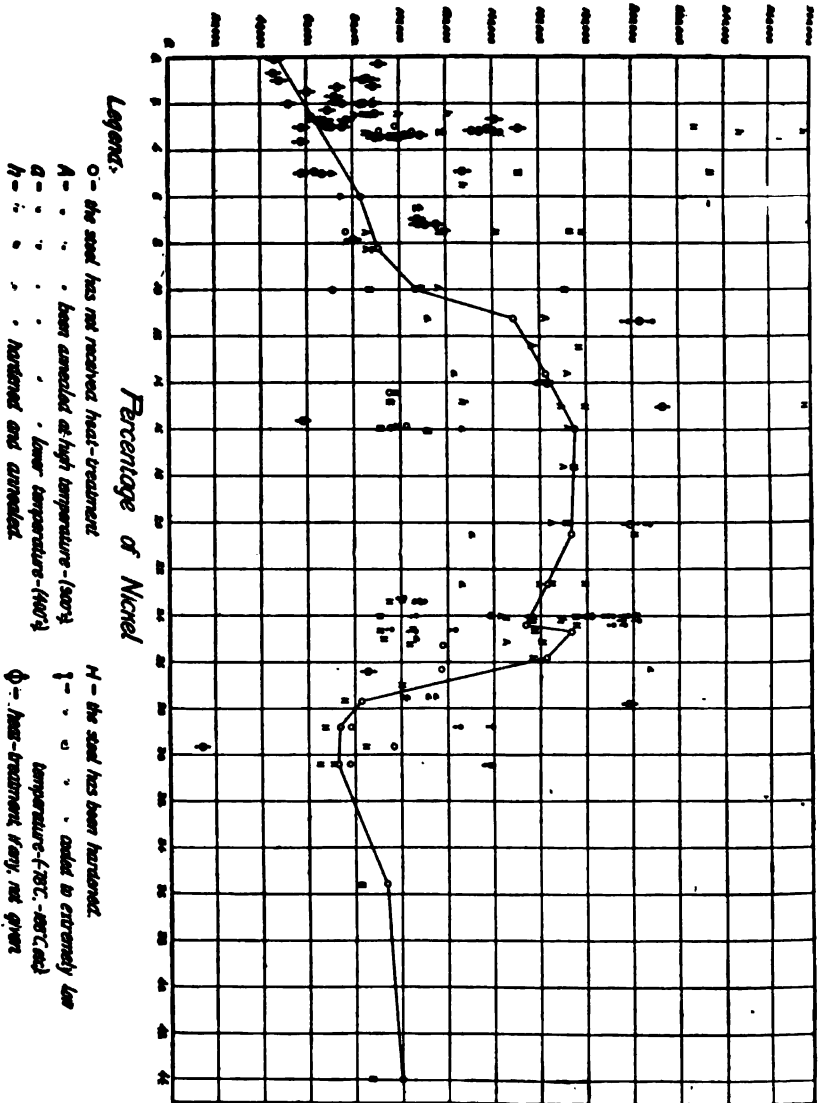

Fig. 81.

Influence of the Proportion of Nickel and Varying Heat-treatment upon the Tensile Strength of Nickel Steel.

NOTE.— The curve here plotted is that given by M. Dumas, *loc. cit.*, p. 18.

it has again cooled he can drill through it and introduce his charge of dynamite. But neither this nor any other known procedure softens manganese steel. This very fact that when cold it is unalterably hard has, however, limited its use, because of the great difficulty of cutting it to shape, which has in general to be done with emery wheels instead of the usual iron-cutting tools. Another defect is its relatively low elastic limit.

Fig. 83 shows the remarkable increase of tensile strength which occurs when the manganese rises from 7 to 13 per cent, and the decline of tensile strength as the manganese increases still farther. By the contrast between the position of the crosses and the black dots it shows also the remarkable effect of sudden cooling.

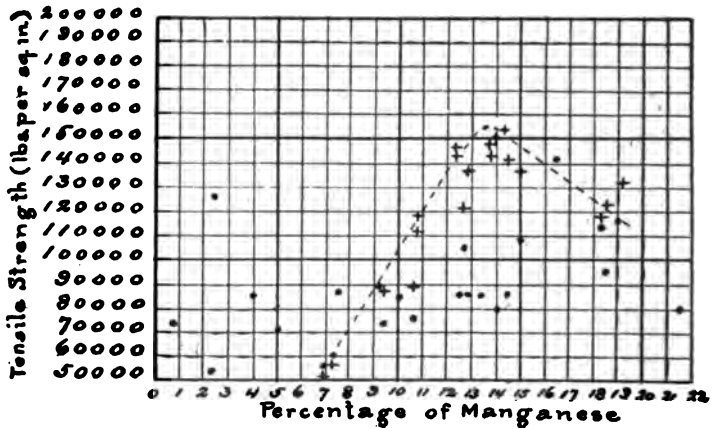

Fig. 83. Influence of the Proportion of Manganese on the Tensile Strength of Manganese Steel.

Legend:

• = Slowly cooled manganese steel.

+ = Water-toughened or suddenly cooled manganese steel.

Fig. 84 shows the corresponding changes in ductility. To show that the maxima for tensile strength and ductility coincide the tensile strength curve sketched by eye in Fig. 83 is reproduced in Fig. 84.

In Fig. 85 is shown the degree to which manganese steel combines tensile strength with ductility, and in Fig. 86 the degree to which it combines ductility with elasticity. These combinations are often taken as a rough measure of the general degree of excellence of a metal for engineering purposes. For comparison the corre-

sponding properties of carbon steel are shown by small black dots, which fall in a pretty well defined band, much below the manganese steel crosses.

These comparisons may, however, give a false idea of the ductility of manganese steel. If two metals elongate in a like manner, the extent of their elongation may be a fair comparative

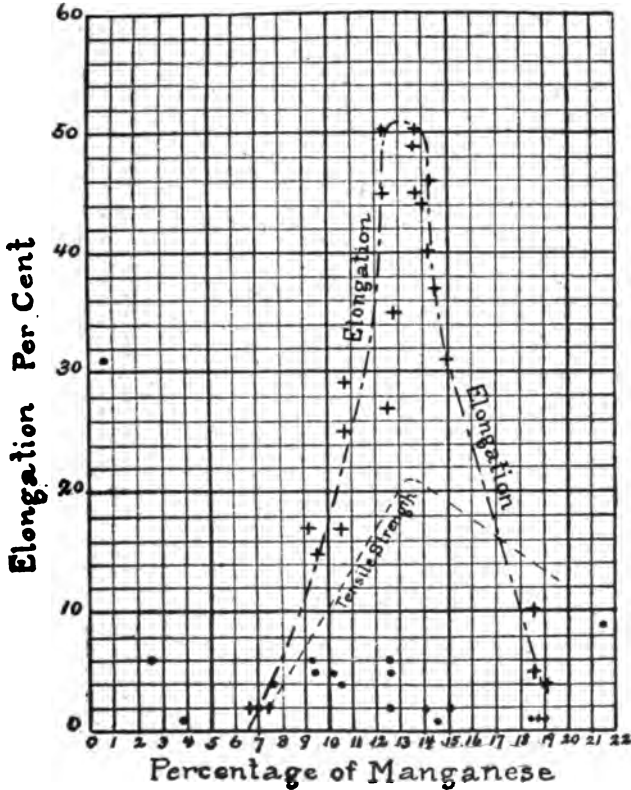

Fig. 84. Influence of the Proportion of Manganese on the Ductility of Manganese Steel.

Legend:

- = Slowly cooled manganese steel.
- ‡ = Water-toughened or suddenly cooled manganese steel.

measure of their ductility; not necessarily so, however, when their mode of elongating is unlike in kind. A bar of carbon steel habitually yields by "necking" when pulled in two, contracting greatly just about the place where rupture occurs, while a bar of man-

ganese steel or of brass elongates far more uniformly over its whole length. For some purposes this uniform stretch may be better, for others worse, than the necking and localized stretch of carbon steel; suffice it here to point out that the two are different, and, therefore, not strictly comparable as a measure of ductility; and further that, thanks to the nearly uniform stretch of manganese steel over the

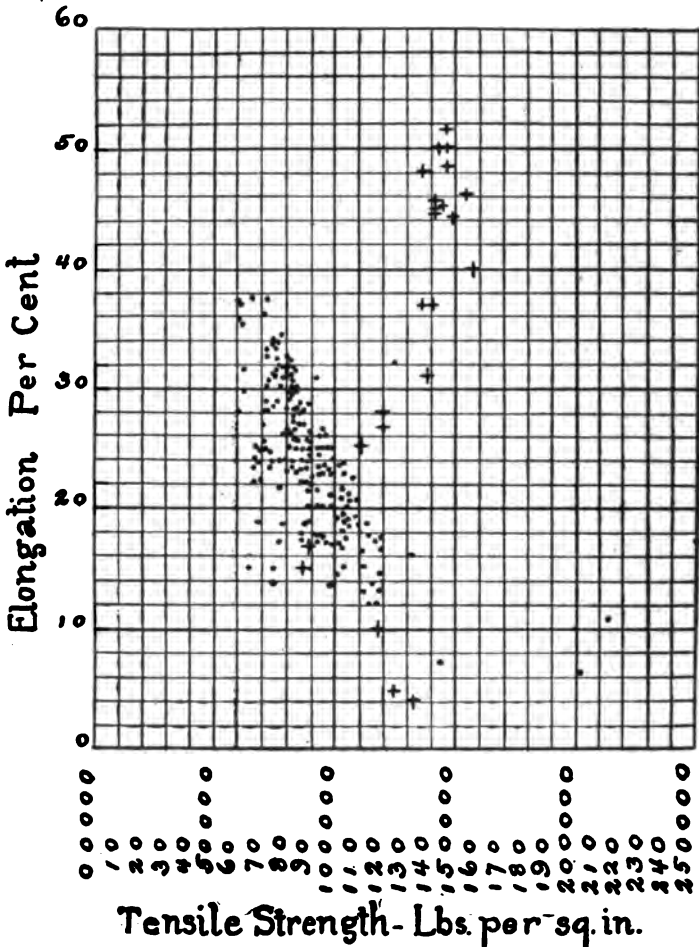

Fig. 85. Tensile Strength and Ductility of Carbon Steel and of Manganese Steel.

Legend:

- = Carbon steel.
- + = Water-toughened or suddenly cooled manganese steel.

whole length of the test-bar, its percentage of elongation may be held to give an exaggerated idea of the metal's true ductility.

261. CHROME STEEL, which usually contains about 2 per cent of chromium and 0.80 to 2 per cent of carbon, owes its value to

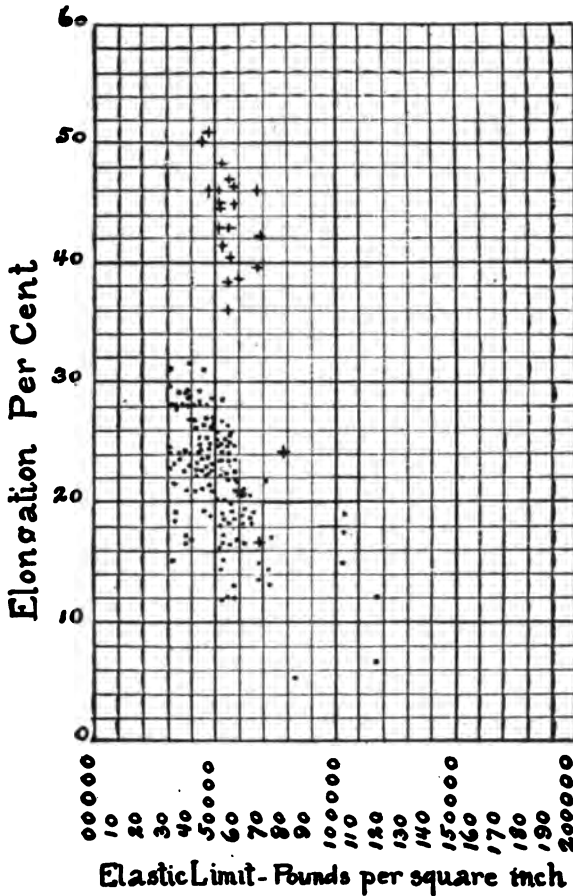

Fig. 86. Elasticity and Ductility of Carbon Steel and of Manganese Steel.

Legend:

• = Carbon steel.

+ = Water-toughened or suddenly cooled manganese steel.

combining, when in the "hardened" or suddenly cooled state, intense hardness with a high elastic limit, so that it is neither deformed permanently nor cracked by extremely violent shocks. For

this reason it is the material generally if not always used for armor-piercing projectiles. It is much used also for certain rock-crushing machinery (the shoes and dies of stamp-mills), and for safes. These last are made of alternate layers, usually five in number, of chrome steel and wrought iron, welded together, and then cooled suddenly so as to harden the chrome steel. The hardness of the hardened chrome steel resists the burglar's drill, and the ductility of the wrought iron the blows of his sledge.

262. **TUNGSTEN STEEL**, which usually contains from 5 to 10 (and sometimes even 24) per cent of tungsten and from 0.4 to 2 per cent of carbon, is used for magnets, because of its great retentivity, and for lathe and similar metal-cutting tools which are to cut off a very thick slice at each stroke. The great friction, due to the thickness of the cut, heats the tool to a temperature at which the temper of common or "carbon" steel is drawn. The merit of tungsten steel is that, like manganese steel, it retains its extreme hardness, even after it has been heated to 400° C. (752° F.). Under these conditions the Taylor and White variety retains its cutting power even when the friction is so great that the chips of metal cut are so hot as to glow visibly, and even the edge of the tool itself grows red-hot. I have watched these tools at work very carefully, and they certainly appeared to be red-hot at their cutting edge, while still cutting steel rapidly and efficiently.

The normal composition of this Taylor-White steel is as follows:

	For Cutting Soft Steel and Gray Cast Iron	For Cutting Hard Steel
Carbon, per cent	0.75 to 1.00	1.25
Chromium, per cent	3.00	4.00
Tungsten, per cent	8.50	8.50

The composition of many of the good self-hardening steels of the present time lies between the following limits:*

Carbon	0.40 to 2.19 per cent
Chromium	0.00 to 6.00 "
Tungsten.	3.44 to 24.00 "
Silicon	0.21 to 3.00 "

The present tendency appears to be in the direction of replacing the chromium of steels for high-speed cutting tools with from 1.25 to 4 per cent of manganese.

* J. A. Mathews, Ph. D., private communication.

263. **MOLYBDENUM STEEL.** — Molybdenum is now often used instead of tungsten, 1 per cent of the former replacing 2 per cent of the latter, so that the ratio between their effects appears to be that which their atomic weights would lead us to expect. In other words, one molecule of molybdenum appears to have the same effect as one molecule of tungsten.

264. **DEEP CARBURIZING; HARVEY AND KRUPP PROCESSES.** — Much of the heavy side armor of war-vessels is made of nickel steel initially containing so little carbon that it cannot be hardened, *i. e.*, it remains very ductile even after sudden cooling. The impact face of these plates is given the intense hardness needed, by being converted into high-carbon steel, and then hardened by sudden cooling. Harvey carburized the impact face to a depth of about an inch by heating the plate for about a week to about 1200° C. (2192° F.), with that face strongly pressed against a bed of charcoal. The Krupp process, a newer one, carburizes the impact face by exposing it at a high temperature to illuminating gas. This is decomposed by the heat, and deposits on the face of the plate a layer of fine carbon, which is absorbed by the steel as in the cementation process. In either case the impact face thus carburized is cooled suddenly from a red heat, *e. g.*, by spraying it with iced brine. An intensely hard impact surface results, the hardness decreasing gradually from this face inwards. Thanks to the glass-hardness of the face, the projectile is arrested so abruptly that it is shattered, and its energy is delivered piecemeal by its fragments; but as the face is integrally united with the unhardened, ductile, and slightly yielding interior and back, the plate, even if it is bent backwards somewhat by the blow, neither cracks nor flakes.

265. **THE GENERAL SCHEME OF IRON MANUFACTURE** is shown diagrammatically in Fig. 87. To explain, practically all the iron ore mined is smelted in the iron blast-furnace, and its iron is thereby converted into the crude form of pig iron or cast iron. This cast iron may, following path 1, be used in the arts in the form of castings of cast iron, or, following path 2, it may be converted into wrought iron or steel, which may be used in the common form of rolled or hammered products, or in case of steel, in the form of steel castings.

If path 1 is followed the castings may be either (A) gray, (B) chilled, or (C) malleable. The quantity of gray cast iron

castings used is incomparably greater than that of either chilled or malleable cast iron castings.

(A) In making gray cast iron castings, the crude cast iron undergoes very little chemical change, indeed simply that incident to its remelting in the foundry for the purpose of casting it.

(B) In making chilled cast iron castings though the ultimate composition of the cast iron is changed very little, special hardness is given by chilling, *i. e.*, rapidly cooling the metal when it is poured into its moulds, and in many cases further metamorphic changes, *i. e.*, changes in the microscopic constitution, are brought about by heat-treatment (annealing).

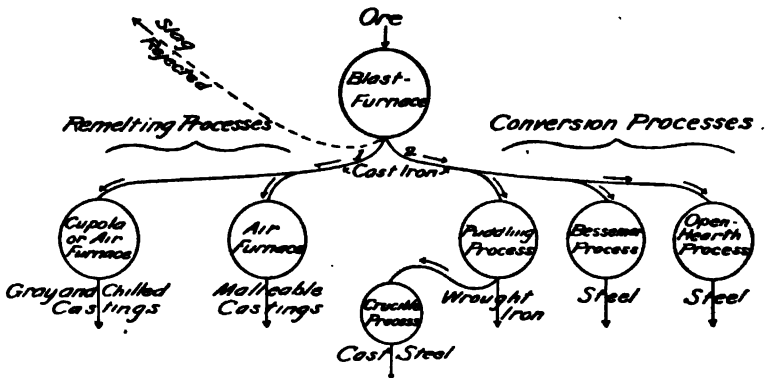

Fig. 87. The General Scheme of Iron Manufacture.

(C) In making malleable cast iron castings the ultimate composition of the metal is first changed somewhat by an oxidizing melting, which, however, leaves the metal still in the condition of white cast iron, an exceedingly brittle substance. This is cast into the various forms in which the metal is to be used in the arts, and these brittle castings are then made relatively strong and malleable by a long heating or "annealing" process, which acts chiefly through inducing a metamorphic change, *i. e.*, a change in the microscopic constitution, changing the condition of the carbon and iron from that of the glass-hard, brittle cementite, Fe_3C , to that of soft ductile free iron or ferrite, intermingled with very finely divided graphite. Moreover a small quantity of the carbon is removed by surface oxidation.

If path 2 is followed the metal has to undergo a very great purification, and it is of this purification that its conversion into wrought iron or steel really consists.

To explain, the blast-furnace process by which the cast iron is made, is necessarily a highly carburizing one, so that the cast iron necessarily contains much carbon. Further, the iron ore usually contains much silica (SiO_2), and some phosphoric acid in the form of apatite ($3\text{CaO}, \text{P}_2\text{O}_5$), together with more or less manganese in the form of manganic oxide (MnO_2) and sulphur in the form of pyrites (FeS_2). Now the blast-furnace process is so very strongly deoxidizing that most of this phosphoric acid is deoxidized, as is much of the manganic oxide and some of the silica; and the unoxidized phosphorus, manganese and silicon which result unite with the molten cast iron, because they are unoxidized. At the same time some of the sulphur initially present as pyrites passes into the cast iron, which thus consists of metallic iron contaminated with these other elements, or impurities.

The following reactions may serve as types of those by which the deoxidation takes place in the blast-furnace:

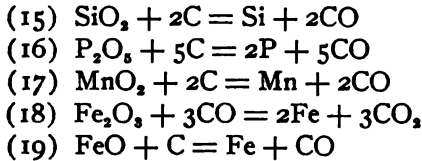

The essential difference between cast iron on one hand and wrought iron and steel on the other, is that the former contains always much more carbon, usually more silicon, and often more manganese, phosphorus and sulphur than are permissible in the latter; and the essence of all the processes by which cast iron is converted into wrought iron or steel is the elimination of these foreign elements. The difference between the two classes may be illustrated by the following case.

	Cast Iron for the Basic Bessemer Process, Per cent	Basic Bessemer Steel, Per cent
Carbon	3.50	0.10
Silicon	1.00	0.01
Manganese	1.80	0.50
Phosphorus	1.80	0.07
Sulphur	0.10	0.07

The carbon, silicon, phosphorus and manganese are eliminated by oxidizing them, and the same is true of sulphur to a certain extent. The ultimate source of the oxygen may be either the atmospheric air as in the Bessemer process, or iron oxide such as native magnetite as in the puddling process, or both these jointly as in the open-hearth process. But even when atmospheric oxygen is used it appears that this acts rather indirectly than directly. That is to say, the atmospheric oxygen appears to act by oxidizing some of the iron itself to ferrous oxide, FeO, or by oxidizing ferrous oxide to magnetic oxide (FeO to Fe₃O₄); and the actual oxidation of the carbon and other foreign elements seems to be effected by the means of the iron oxides thus formed rather than by the means of the atmospheric oxygen directly.

The reactions by which the oxidation takes place are of the following types :

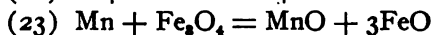
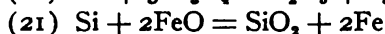
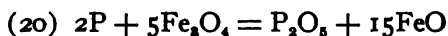

These reactions must be taken only as types. In case of each of these five foreign elements it is probable that the oxidation may take place either through ferrous oxide (FeO), or magnetic oxide (Fe₃O₄).

Of the oxidized products of these reactions the oxides of carbon and sulphur (carbonic oxide, CO, carbonic acid, CO₂, and sulphurous acid, SO₂) are volatile and immediately escape. The oxides of phosphorus, silicon and manganese (phosphoric acid, P₂O₅, silica, SiO₂, and manganous oxide, MnO) separate mechanically from the iron as oil separates from water, and coalesce with any other oxidized substances present to form the slag, which is an opaque, earthy, lava-like or vitreous mass, chiefly a silicate of iron oxide, lime, magnesia, and alumina in very varying proportions, together with phosphoric acid under certain conditions. This slag, when molten, floats upon the molten metallic iron, because it is relatively light, and the two therefore are very readily separated mechanically.

These purifying reactions are brought about (1) in the puddling process by stirring iron oxide (in the form of a silicate very

rich in that oxide) into the molten cast iron as it lies in a thin boiling layer on the hearth of a reverberatory furnace (Fig. 96, p. 345); (2) in the Bessemer process by blowing cold atmospheric air through the molten cast iron in a deep clay-lined or dolomite-lined retort called a converter, the rapidity of the oxidation itself raising the temperature rapidly; and (3) in the open-hearth process by exposing the molten cast iron in a thin and very broad layer on the bottom of a reverberatory furnace to an overlying layer of slag containing iron oxide, and usually enriched in that oxide by throwing into it lumps of iron ore (Fig. 97, p. 348). In this last process, in addition to this purification of the cast iron by these oxidizing reactions, its impurities are in most cases also greatly diluted by adding much relatively pure steel scrap.

In the Bessemer and open-hearth processes the oxidation cannot readily be made thorough enough to remove just the desired quantity of the several impurities initially present; and yet both leave just the quantity of carbon desired, and also leave the iron itself free from oxygen, a most hurtful element, but one easily removed. Hence the purifying or, as it is called, the "fining" phase of each process is usually followed by an extremely brief adjusting or "recarburizing" or "refining" phase, in which the composition is adjusted accurately, chiefly by adding carbon to give the desired percentage of that element, and manganese both to give the needed percentage of manganese and to remove from the iron any oxygen which it may have taken up.

In the crucible process a very small quantity of wrought iron or steel is remelted in a closed crucible and cast into ingots, or into castings. The desired percentage of carbon is given either (1) by previously carburizing the solid metal by very long heating in contact with charcoal; or (2) by adding charcoal or a rich iron carbide (washed-metal) to the charge in the crucible itself. The crucible process is thus in effect a simple remelting process, with or without simultaneous carburizing, and is thus distinguished sharply from the puddling and Bessemer processes, which are essentially purifying processes. The open-hearth process may be conducted either chiefly as a remelting process (pig and scrap) or as a purifying process (pig and ore), or it may combine both principles (pig and scrap and ore).

265 *A. CLASSIFICATION OF PROCESSES.*—We may roughly classify the more important processes as follows:

1. **THE EXTRACTION PROCESSES**, the blast-furnace, and the "direct processes" of making steel or wrought iron direct from the ore; these latter are unimportant to-day.

2. **THE CONVERSION OR PURIFYING PROCESSES**, the Bessemer, open-hearth and puddling processes. The Bell-Krupp process is one of arrested or incomplete purification. The purification consists chiefly in removing by oxidation the excess of carbon, silicon, phosphorus and manganese introduced in the blast-furnace process, over that desired in the steel or wrought iron.

3. **THE ADJUSTING PROCESSES**, adjusting the composition. These include the *carburizing processes*, cementation, case-hardening and the Harvey and Krupp processes; and the process of making *malleable cast iron*.

4. **THE SHAPING PROCESSES**. These include the *mechanical processes*, rolling, hammering, wire-drawing, *etc.*, and the *remelting processes*, those of the iron foundry and the crucible process. The pig and scrap variety of the open-hearth process may, from one point of view, be put here.

Such classifications can rarely be complete or consistent. For instance, while the crucible process as carried out in Great Britain is essentially a remelting process, as carried out in this country it is at once a remelting and an adjusting (carburizing) process. Nevertheless these classifications have their use.

Extraction of Iron from its Ores

266. **THE BLAST-FURNACE PROCESS.** — To-day practically all of the iron ore mined is smelted in the iron blast-furnace and there converted into cast or pig iron; and this is the case whether the resultant iron is to be used in the form of cast iron, or whether it is to be converted into one of the two other great commercial classes of iron, wrought iron and steel. It is true that there are many direct processes, by which wrought iron or steel may be made directly from the ore, without first converting it into cast iron, *i. e.*, without first putting into it more carbon and silicon than it needs in its finished form, and then taking them out at great expense. But these processes are to-day of little more than historical or scientific interest. Whatever promise they may have had in recent decades has been killed by the great cheapening of the blast-furnace process.

It is also true that a little ore is used in the puddling and open-hearth processes, and that a part of the iron of this ore is recovered. But the quantity of ore used for this purpose is trifling compared with that smelted in the blast-furnace.

The blast-furnace has a very great advantage over the direct processes of extracting wrought iron or steel from the ore, in recovering nearly the whole of the iron present, and in delivering both its products, the metal and the slag, in a molten state, in which they can be handled far more cheaply than if solid or pasty. It is not easy to see how either of these things can be accomplished by any direct process. The advantages of the blast-furnace are so great, that not only have the direct processes practically ceased to exist, but we can hardly see in what way they are to be revived, unless it be through some modification of the blast-furnace process itself, which shall bring the composition of its product nearer to that of steel, *i. e.*, shall give it less carbon and silicon than are present in cast iron as now made.

The stumbling-block in the way of developing such a modification is the removal of sulphur, a most hurtful element of which most ores contain more than is permissible in the steel. The processes for converting cast iron into steel can now remove phosphorus easily, but the removal of sulphur in them is so difficult that it has to be accomplished for the most part in the blast-furnace process itself; and we do not see how the blast-furnace process can keep its desulphurizing power and yet cease to introduce much carbon and silicon into the pig iron.

The cheapening which has taken place in the blast-furnace process has been in very large part through the introduction of mechanical appliances for handling the ore, flux, and fuel on one hand, and the products, the iron and slag, on the other; through better protection of the inner walls of the furnace by more effective water cooling; and through a remarkable increase in the rate of production per furnace chiefly due to the use of extremely powerful blowing engines and blast-heating stoves. But the latest great advance, the use in gas engines of the waste gases escaping from the top of the furnace, is perhaps the most striking and important of all. We will now take these points up in series.

267. THE HANDLING OF RAW MATERIALS.—That any of the raw materials should be shovelled by hand is a thing no longer even to be considered in designing new works, at least in the United

States. The arrangement at the Carnegie Company's Duquesne works (Fig. 88) may serve as an example of modern methods of handling.

The standard-gauge cars which bring the ore and coke to Duquesne pass over one of three very long rows of bins, *A*, *B*, and *C* (Fig. 88), of which *A* and *B* receive the materials (ore, coke, and limestone) for immediate use, while *C* receives those to be stored for winter use. From *A* and *B* the materials as they are needed are drawn into large buckets (*D*) standing on cars, which carry them to the foot of the hoist track *EE*, up which they are hoisted to the top of the furnace. Arrived here, the material is introduced into the furnace by an ingenious piece of mechanism without allowing any of the furnace gas to escape. The hoist-engineer in the house *F* at the foot of the furnace, when informed by means of an indicator that the bucket has arrived at the top, lowers it so that its flanges (*GG*, Fig. 89) rest on the corresponding fixed flanges *HH*, as shown in Fig. 90. The further descent of the bucket being thus arrested, the special cable *T* is now slackened, so that the conical bottom of the bucket drops down, pressing down by its weight the counter-weighted false cover *J* of the furnace, so that the contents of the bucket slide down into the space between this false cover and the true charging bell, *K*. The special cable *T* is now tightened again, and lifts the bottom of the bucket so as both to close it and to close the space between *J* and *K*, by allowing *J* to rise back to its initial place. The bucket then descends along the hoist-track to make way for the next succeeding one, and *K* is lowered, dropping the charge into the furnace.

Thus some 1700 tons of materials are charged daily into each of these furnaces without being shovelled at all, running by gravity from bin to bucket and from bucket to furnace, and being hoisted and charged into the furnace by a single engineer below, without any assistance or supervision at the furnace top.

The winter stock of materials is drawn from the left-hand row of bins, and distributed over immense stock piles by means of the great crane *LL* (Fig. 88), which later transfers it as it is needed to the row *A* of bins, whence it is carried to the furnace as already explained.

268. HANDLING THE MOLTEN CAST IRON.—A great saving of labor was effected by the introduction of "pig-breaking" machines. A whole row or litter of pigs with its sow was lifted

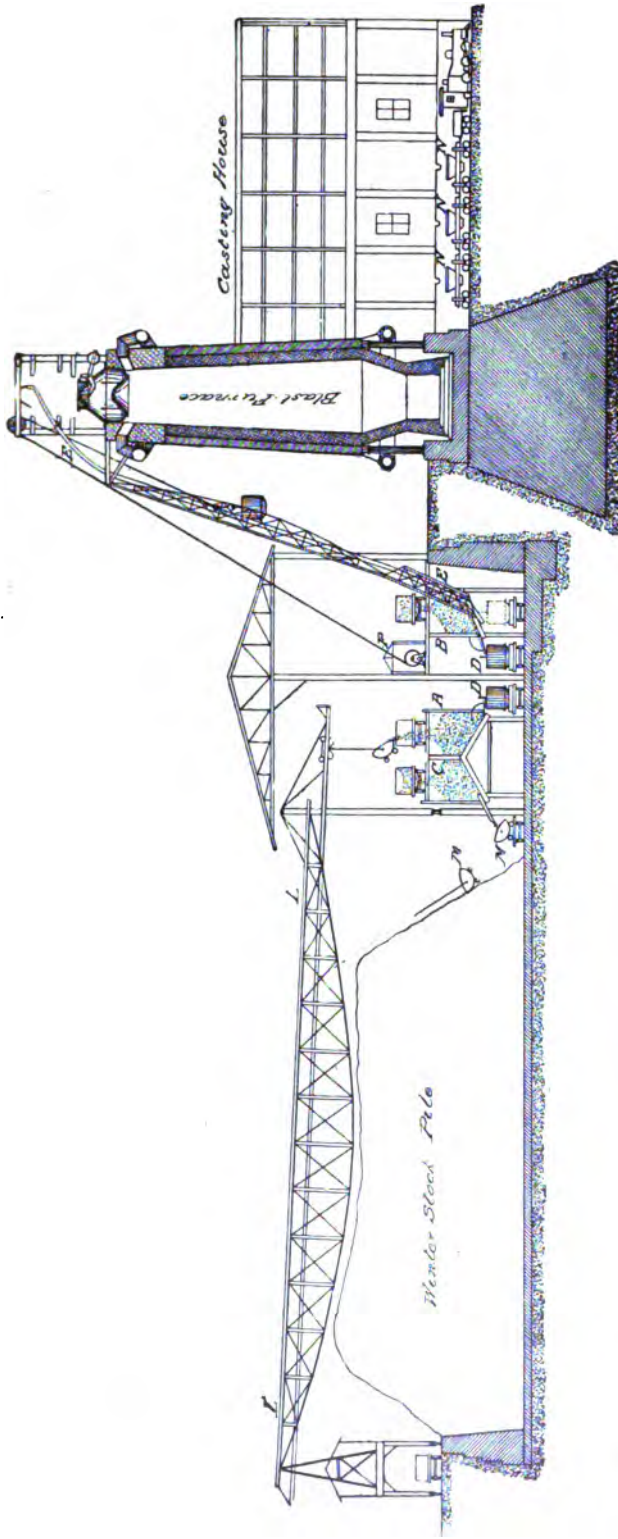

Fig. 88. Diagram of the Carnegie Blast-furnaces at Duquesne, Pa.

A and *B*, bins for stock for immediate use; *C*, receiving bin for winter stock pile; *DD*, ore bucket; *EE*, hoist track; *F*, hoist engine-house; *I. L.*, travelling crane commanding stock pile; *M*, ore bucket receiving ore for stock pile; *M'*, bucket removing ore from stock pile; *N, N, N*, ladles carrying the molten cast iron to the Bessemer Steel Works, etc.

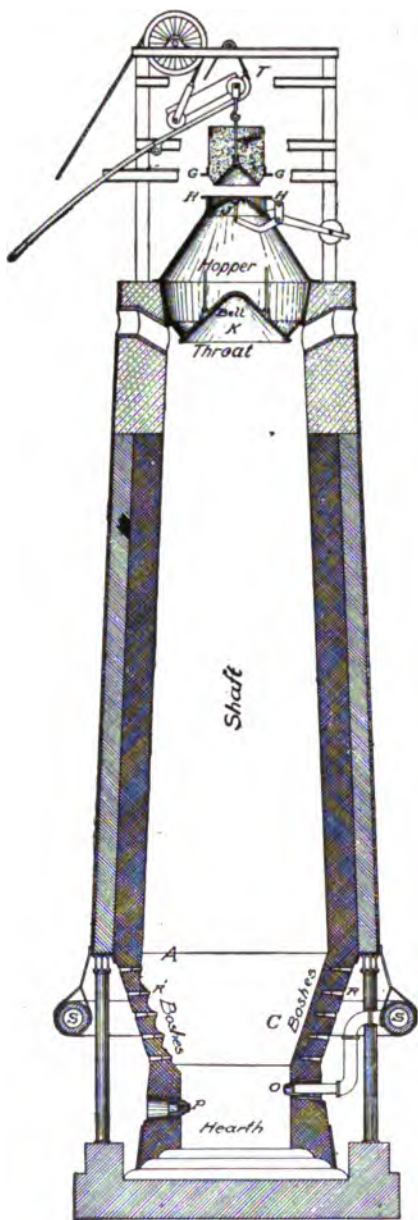

Fig. 89. Section of one of the Duquesne Blast-furnaces.

GG, flanges on the ore bucket; *HH*, fixed flanges on the top of the furnace; *J*, counter-weighted false bell; *K*, main bell; *O*, tuyere; *P*, cinder notch; *R, R'*, water-cooled boxes; *S*, blast pipe.

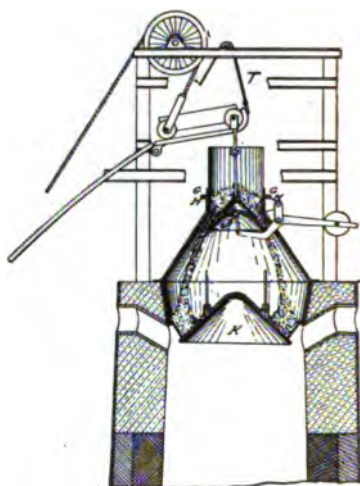

Fig. 90.

The transfer of the ore from the bucket to the main charging-bell.
 Lettering as in Fig. 89.

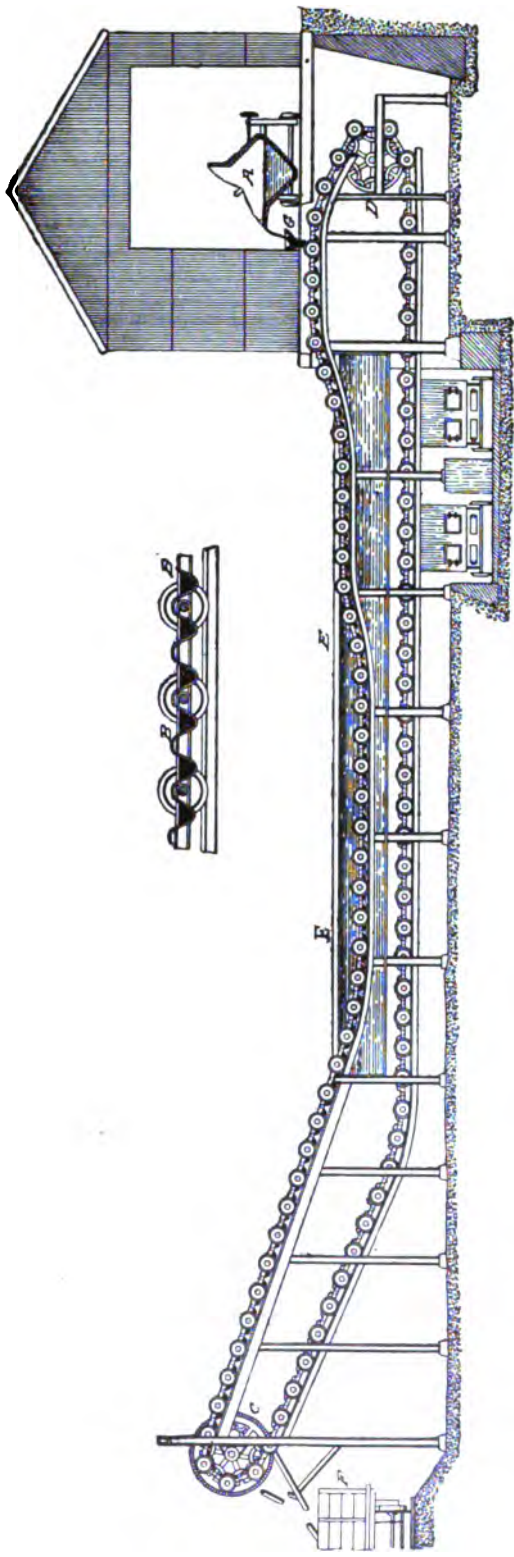

Fig. 91. Diagram of Uehling's Pig-casting Machine.

A, ladle bringing the cast iron from the blast-furnace; *B, B'*, the moulds; *C, D*, sheaves, carrying the endless chain of moulds; *E, E'*, tank in which the moulds are submerged; *F*, car into which the cooled pigs are dropped; *G*, distributing funnel.

from its moulds by a travelling crane, and placed on rollers which progressively fed it forward, one pig at a time, under a hydraulic press with three plungers, of which one broke off the sow between a given pig and its neighbor, and two others broke the pig itself into three pieces, which slid down into a car beneath. The iron is handled still more cheaply by the Uehling type of casting machine (Fig. 91), which consists essentially of a series of thin steel moulds *BB*, carried by endless chains past the lip of a great ladle *A*. This pours into them the molten cast iron which it had just received direct from the blast-furnace. As the string of moulds, each thus containing a pig, moves slowly forward, the pigs solidify and cool, the more quickly because in transit they are sprayed with water, or even submerged in water in the tank *EE*. Arrived at the further sheave *C*, the now relatively cool pigs are dropped into a railway car. Besides a very great saving of labor, which, however, is partly counterbalanced by the cost of repairs, these machines have the great merit of making the management independent of a very troublesome set of laborers, the hand pig-breakers, who were not only absolutely indispensable for every cast and every day, because the pig iron must be removed promptly to make way for the next succeeding cast of iron, but very difficult to replace because of the great physical endurance required.

269. PRESERVATION OF THE FURNACE WALLS.—The combined fluxing and abrading action of the descending charge tends to wear away the lining of the furnace where it is hottest, which of course is near its lower end, thus changing its shape materially, lessening its efficiency, and in particular increasing the consumption of fuel. The walls therefore are now made thin, and are thoroughly cooled by water, which circulates through pipes or boxes bedded in them. Mr. James Gayley's method of cooling, shown on a small scale in Fig. 89, and in detail in Fig. 92, is to set in the brickwork walls several horizontal rows of flat water-cooled bronze boxes, *RR'*, extending nearly to the interior of the furnace, and tapered so that they can readily be withdrawn and replaced in case they burn through. The brickwork may wear back to the front edges of these boxes, or even, as is shown at *R'*, Fig. 89, a little farther, so that between the several horizontal rows of boxes the walls are grooved scallopedwise, with horizontal furrows. But even in this case the front edges of these boxes still determine the effective profile of the furnace walls, because these furrows become

filled with carbon and scoriaceous matter when the furnace is in normal working. Each of these rows, of which five are shown in Fig. 89, consists of a great number of short segmental boxes.

270. BLAST-FURNACE GAS ENGINES.—The gases which escape from the top of the blast-furnace are necessarily very rich in carbonic oxide, of which they usually contain between 20 and 26 per cent, and they are thus a very valuable fuel. They have hitherto been used chiefly for heating the blast, and for raising

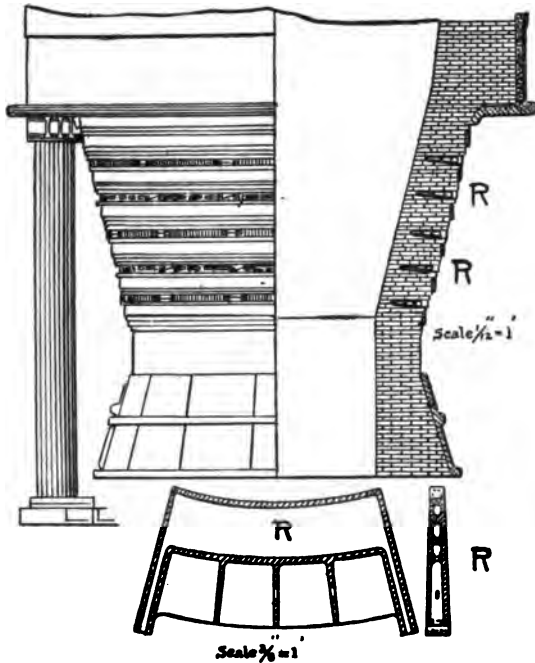

Fig. 92. Gayley's Water-cooling Blocks for Cooling the Inner Face of the Walls of Blast-furnaces.

(*Trans. Am. Inst. Mining Engineers*, XXI, p. 109, Fig. 6.)

steam not only for generating that blast, but also more lately for the rolling-mill and other engines of the establishment. But it has now been shown that these gases can be used directly in gas engines, in which they generate about four times as much power as would be developed by the steam raised by burning them under boilers. It has been calculated that the gas from a pair of old-fashioned blast-furnaces, making 1600 tons of iron per week,

would in this way yield some 16,000 horse-power in excess of their own requirements. At that rate a pair of the great American furnaces would have some 70,000 horse-power over and above that which they themselves need for raising steam for their own purposes, and for heating their own blast. Although the quantity may really be much less than this, because the higher efficiency of these furnaces leaves less residual calorific power in the waste gases, it is clear that their importance as sources of power is very great.

This use of the gas engine is likely to have far-reaching results. In order to make use of this power we should place in the immediate neighborhood of the blast-furnaces themselves the works in which their cast iron is to be converted into steel, and also those in which this steel is to be rolled out into finished shapes. The many converting mills which treat pig iron made at a distance will now have the crushing burden of providing in other ways the power which their rivals get from the blast-furnace, in addition to the severe disadvantage under which they already suffer, of wasting the initial heat of the molten cast iron as it runs from the blast-furnace.

271. **HOT BLAST STOVES.**—The cast iron or “pipe” stoves, in which the blast was heated by passing through a long series of cast iron pipes, around and outside which the waste gases of the blast-furnace itself were burnt, are fast going out of use, chiefly because they are destroyed quickly if an attempt is made to heat the blast above 1000° F. (538° C.). In their place the regenerative stoves of the Whitwell (Figs. 93 and 94) and Cowper (Fig. 95) types are chiefly used. With these the regular temperature of the blast at some works is about 760° C. (1400° F.), and the usual blast temperature lies between 480° and 650° C. (900° and 1200° F.)

Like the Siemens furnace, they have two distinct phases—one “on gas,” during which part of the waste gas of the blast-furnace is burnt within the stove, highly heating the great surface of brickwork which for that purpose is provided within it; the other, “on wind,” during which the blast is heated by passing it back over these very surfaces which have thus been heated. They are heat-filters or heat-traps for impounding the heat developed by the combustion of the furnace gas, and later returning it to the blast.

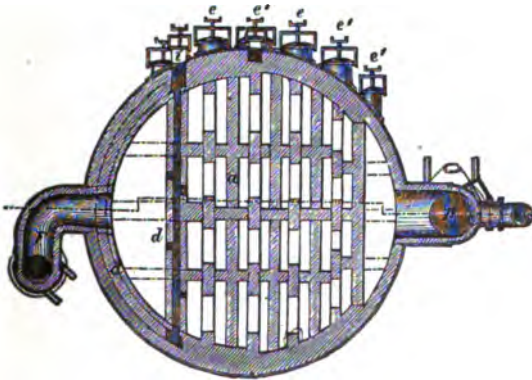
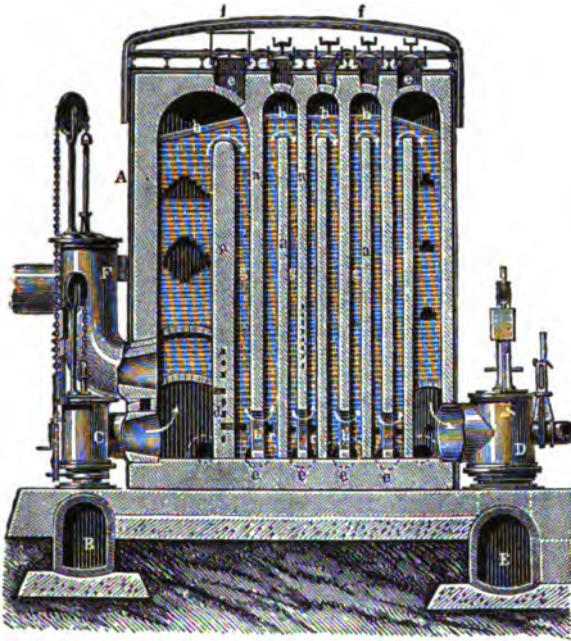

Fig. 93. Early Type of the Whitwell Hot-blast Stove.
(Ledebur, *Handbuch der Eisenhüttenkunde*, 3d Ed., 1899, p. 468.)

Each blast-furnace is now provided with three or even four of these stoves, which collectively may be nearly thrice as large as the furnace itself. At any given time one of these is "on wind" and the others "on gas."

In later examples the Whitwell stove has been simplified by greatly lengthening it and reducing the number of its vertical partitions from nine to three, so that the blast, and also the gas, has only three instead of nine reversals of direction, and the

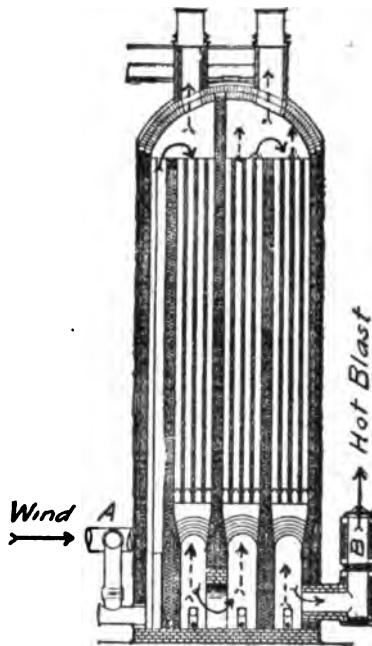

Fig. 94. H. Kennedy Hot-blast Stove.
(Whitwell Class.)

NOTE.— When "on wind," the cold blast is forced in at *A*, and passes four times up and down as shown by means of unbroken arrows, escaping as hot blast at *B*.

When "on gas," the gas and air enter at the bottom of each of the three larger vertical chambers, pass once up through the stove, and escape at the top, as shown by means of broken arrows.

Thus this is a four pass stove when on wind, but a one-pass stove when on gas.

Trans. Am. Inst. Mining Engineers, XXI, p. 722, 1893.

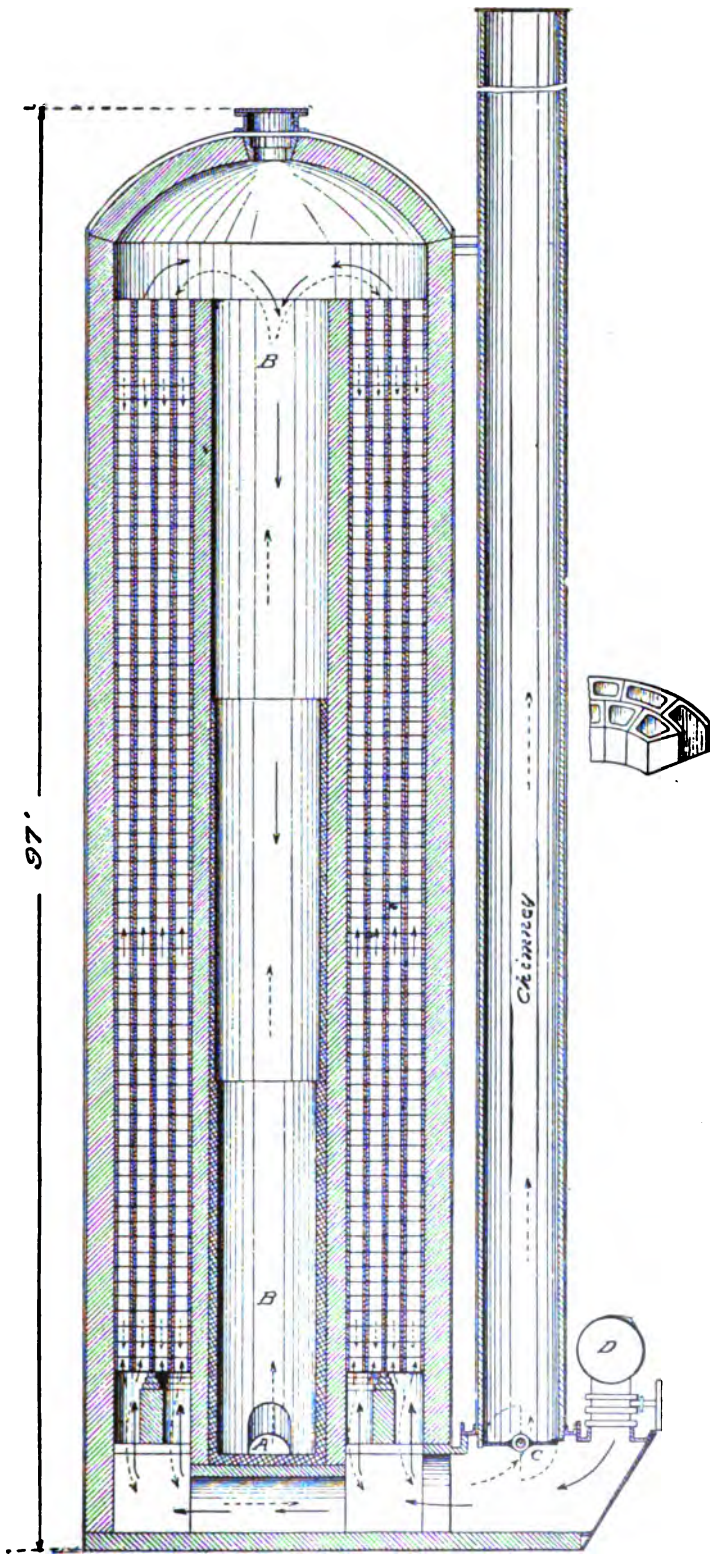

Fig. 95. Diagram of the J. Kennedy Variety of the Cowper Hot-blast Stove at Duquesne.

A, entrance for blast-furnace gas; *B*, *B*, combustion chamber; *C*, chimney valve; *D*, cold-blast main.

Broken arrows show the path of the gas and air while the stove is "on gas," and solid arrows that of the blast while it is "on wind."

blowing engine has just so much less frictional resistance to overcome. The necessary heating surface is given by three high partitions instead of by nine short ones.

Fig. 93 shows the early form of the Whitwell stove. The gas and the air which is to burn enter it at the lower part of the left-hand vertical chamber, which is made wide so as to permit thorough mixing and combustion. Thence, as shown by the arrows, the products of their combustion pass up and down the nine vertical passages at the right of the combustion chamber, giving up their heat to the brickwork partitions. In the next phase, when "on wind," the cold blast is forced in at the right-hand side of the stove, and passes back in the reverse direction, absorbing heat from these same partitions, and escaping from the left-hand side as hot blast.

Fig. 94 may serve to illustrate both the modern Whitwell type, and also the Hugh Kennedy stove which has much in common with it. The modern Whitwell lacks the chimneys shown at the top of Fig. 94, and it has a wide combustion chamber at the left instead of the narrow one here shown.

The Hugh Kennedy stove shown in Fig. 94 is an ingenious modification of older ones. Its working is described in a note to the figure.

The Cowper stove (Fig. 95) differs from the Whitwell (Fig. 94) (1) in having not a series of flat smooth walls, but a great number of narrow vertical flues, for the alternate absorption and emission of the heat, with the consequence that, for given outside dimensions, it offers about one-half more heating surface than the Whitwell stove; and (2) in that the gas and the blast pass only once up and once down through it, instead of twice up and twice down as in the modern Whitwell stoves. As regards frictional resistance, this smaller number of reversals of direction makes up in a measure for the smaller size of its flues. The large combustion chamber *B* permits thorough combustion of the gas.

272. THE INCREASE IN THE RATE OF PRODUCTION per furnace has been extraordinary. In 1863 a daily production of 50 tons per furnace, and in 1880 one of 115 tons, was unusually large; but in 1898 one of the Duquesne furnaces made 711 tons in a day, and the four furnaces there were making regularly between 2200 and 2300 tons daily, a rate as great as that of the whole world in 1800, and half as great as that of all the United

States furnaces collectively in 1870. At Rankin a single blast-furnace made 790 tons of pig iron in a single day of 24 hours. The rate of production of a single one of these furnaces is much greater than that of all the United States furnaces in 1830, about ten times that of 1820, and nearly four times that of the 153 furnaces in the United States in 1810. (*Later.* — Ohio No. 2 Furnace at Youngstown, Ohio, has made 806 tons of Bessemer pig iron in 24 hours.)

These Carnegie furnaces of course are exceptional ones, and the common rate of production, especially in case of European furnaces, is much less. For instance, in 1899 the average daily production of the eighty-five existing and projected furnaces of Lorraine and Luxemburg was estimated at only 127 tons, and the greatest estimated daily production for any of those then building was only 200 tons. Indeed, it is questioned whether the rapid driving at Duquesne, with its rich Lake Superior ores, would be economical if applied to the lean Minette ores of Luxemburg and Lorraine.

The remarkable increase since 1880 has been brought about, not chiefly by the use of larger furnaces, although the hearth or crucible is made somewhat wider than formerly, but by providing very powerful engines and hot-blast stoves; and it has almost forced the adoption of simple mechanical arrangements for handling rapidly both the raw materials and the products of the furnace.

Between 1880 and 1901 the importance of anthracite as a fuel for iron smelting decreased greatly, and that of charcoal very greatly; thus of the total United States product of pig iron, the percentage made with anthracite decreased in this period from 42 to 11, and that made with charcoal from 13 to 2.

Conversion into Wrought Iron and Steel

273. MANUFACTURE OF WROUGHT IRON. — That wrought iron, which in 1880 seemed about to be completely displaced by mild steel, remains in very extensive use is due chiefly (1) to the conservatism, often reasonable, of certain consumers, (2) to the great ease with which it welds, and (3) to the great purity which can readily be given to it. Thus wrought iron horse-shoes, bars, *etc.*, are made in great quantities for country smiths and others who have had no opportunity to learn the

slightly different treatment which mild steel needs. Welded steam, gas, and water pipes also are still often made of wrought iron instead of steel, because here thoroughness of welding is of the first importance, and because if steel for pipes is made sufficiently free from carbon to weld readily, special care is needed to prevent cavities called "blowholes" (see § 290, p. 368), due to the escape of gas from the steel when the ingots into which it is initially cast are solidifying. These blowholes are liable either to aggravate the effects of rusting by causing local pitting, or to injure the soundness of the thread which is cut at the end of each length of pipe.

As a material for making the better classes of tool steel by remelting by the crucible process, wrought iron is preferred to mild steel, both because it can be made freer than mild steel from certain elements, especially manganese, which are here undesirable, and because the crucible steel made from it is, in the opinion of the best judges, better than that made from mild steel even if of like composition, though why this is so has not been convincingly explained. For the former of these reasons, too, and perhaps also because of its very defect of being laminated by the presence of cinder, wrought iron is more ductile than mild steel under certain special conditions of use, such as those of rivets and horse-shoe nails, many of which are made of it.

While the yearly production of wrought iron in the United States more than doubled between 1870 and 1890, yet since the latter year it has shrunk very much, probably nearly to that of 1870; and between 1870 and 1900 the proportion which the production of wrought iron bears to that of steel diminished very greatly. Of the combined annual production of wrought iron and steel in the United States, that of wrought iron formed 95 per cent in 1870, 63 per cent in 1880, 37 per cent in 1890, and probably not far from 15 per cent in 1899. The corresponding numbers for Great Britain are 34 per cent for 1890, 19 per cent for 1899, and 16 per cent for 1901. In the year 1899 the average number of British puddling furnaces in operation is reported as 1149 out of a total of 1320 in existence. Thus in nineteen years the position of wrought iron changed from that of the chief product to one of secondary importance.

274. THE PUDDLING PROCESS still supplies nearly all the wrought iron made. The numerous mechanical puddling furnaces

which in 1875 or thereabouts were offered so prominently as a means of lessening the very severe labor of the puddler, have for the most part disappeared, even the Danks furnace being now almost forgotten, and puddling is now usually done by hand in the old-fashioned furnaces and in the same way as formerly. The novelties in puddling which here need notice are (1) the Pietzka furnace, (2) a tentative increase in the size of charges treated, and (3) the use of "direct metal," *i. e.*, molten cast iron direct from the blast-furnace.

A much lower temperature is needed during the early part of the puddling process, in which the initial charge of cast iron, a relatively fusible substance, is melted down, than towards the end, when the resultant relatively infusible wrought iron must be

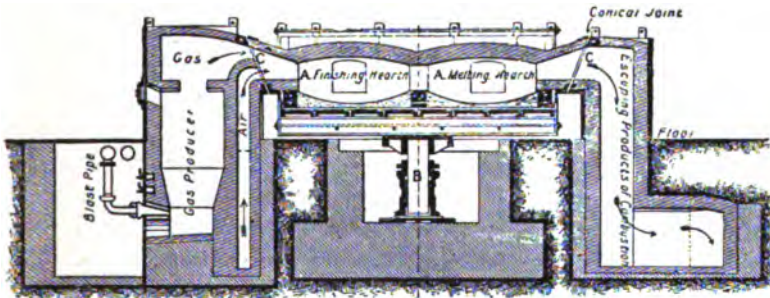

Fig. 96. Diagrammatic Section of the Pietzka Puddling Furnace.

very highly heated so that its particles may be welded firmly together, and so that the cinder shall be so fluid that the greater part of it may readily be squeezed out of the puddled ball. The *Pietzka furnace* (Fig. 96) is designed to meet this condition, by having two separate "hearths" or working chambers, *A, A*, in the right-hand or cooler of which a new charge is melted down and puddling is begun, while in the left-hand hearth, which is hotter because nearer the fire, another charge is finishing. As soon as this latter charge has been drawn from the furnace and the necessary repairs have been made, the two hearths are made to change places, being lifted by means of the hydraulic plunger *B*, and rotated 180° about this plunger as an axis. This brings to the hot end of the furnace the charge of which the treatment has been begun at the cooler end. To permit this rotation the joints *C*, between the rotating parts of the furnace and the fixed

parts, may be made conical. In effect the heat which, in a common puddling furnace, would escape directly from the working chamber into the chimney and thus be lost, is here used in the right-hand or cooler hearth for the early part of the process itself. Beyond this, the heat in the escaping products of combustion may be further recovered by the Siemens regenerative or by the recuperative system. Thus arranged, the Pietzka furnace effects a great saving of fuel.

In common practice the cast iron as it runs from the blast-furnace is allowed to solidify and cool completely in the form of pigs, which are then graded by their fracture, and remelted in the puddling furnace itself. At Hourpes, in order to save the expense of this remelting, the molten cast iron as it comes from the blast-furnace is poured directly into the puddling furnace, in large charges of about 2200 pounds, which are thus about four times as large as those of common puddling furnaces. These large charges are puddled by two gangs of four men each, and a great saving in fuel and labor is effected.

Interesting as are these advances in puddling, they have not been widely adopted, for two chief reasons: First, owners of puddling works have been reluctant to spend money freely in plant for a process of which the future is so uncertain, and this unwillingness has been the more natural because these very men are in large part the more conservative fraction, which has resisted the temptation to abandon puddling and adopt the steel-making processes. Second, in puddling iron which is to be used as a raw material for making very fine steel by the crucible process, quality is the thing of first importance. Now in the series of operations, the blast-furnace, puddling, and crucible processes, through which the iron passes from the state of ore to that of crucible tool steel, it is so difficult to detect just which are the conditions essential to excellence in the final product that, once a given procedure has been found to yield excellent steel, every one of its details is adhered to by the more cautious ironmasters, often with surprising conservatism. Buyers of certain excellent classes of Swedish iron have been said even to object to the substitution of electricity for water-power as a means of driving the machinery of the forge. In case of direct puddling and the use of larger charges this conservatism is reasonable, for the established custom of allowing the cast iron to solidify gives a better opportunity of

examining its fracture, and thus of rejecting unsuitable iron, than is afforded in direct puddling. So, too, when several puddlers are jointly responsible for the thoroughness of their work, as happens in puddling large charges, they will not exercise such care (nor indeed will a given degree of care be so effective) as when responsibility for each charge rests on one man.

275. THE OPEN-HEARTH PROCESS. — In this process, sometimes called the *Siemens-Martin process*, the advances have been more important than those in any other branch of steel making. The chief of these are: (1) the wide use of a basic lining and basic slag, so that the process removes phosphorus from the iron; (2) a great increase in the size of furnaces, from 10 to 50 and even 70 tons' capacity; (3) the use of tilting furnaces; and (4) special modes of procedure.

The American rate of production of the open-hearth process per furnace per week has increased from six heats aggregating 30 tons in 1870 to 22 heats aggregating 1,129 tons, the production of a 50-ton furnace at Duquesne when treating charges composed of 34.3 per cent of molten pig iron, 10.5 per cent of cold pig iron, and 55.2 per cent of scrap iron.

In 1880 the radical defect of the open-hearth process, like that of the Bessemer process, was that it did not remove phosphorus, a most hurtful element, of which nearly all pig irons contain more than is desirable, and most of them more than is permissible, in steel. The essence of both these processes as we have seen is the removal, by oxidation, of the impurities, carbon, silicon, manganese, etc., which the molten cast iron contains.

The carbon oxidizes to carbonic oxide gas which escapes; the silicon oxidizes to silica, and the manganese to manganous oxide, and the resultant silica and manganous oxide unite with the slag, which floats in a thin layer on the molten metal, like cream on simmering milk.

The condition of things in the open-hearth process is sketched in Fig. 97. The right-hand half of this figure shows the charge in a state of violent boiling, due to the reaction between the oxygen of the dark lumps of iron ore which have been thrown in, and now lie floating between metal and slag, and the carbon of the molten metal, $C + O = CO$. The resultant carbonic oxide gas escapes in great volumes and converts the slag into a thick frothing mass. The condition of things at the end of this process, when

Half Section

Showing condition of charge when boiling very gently.

Half Section

Showing condition of charge when boiling violently during ore-ing.

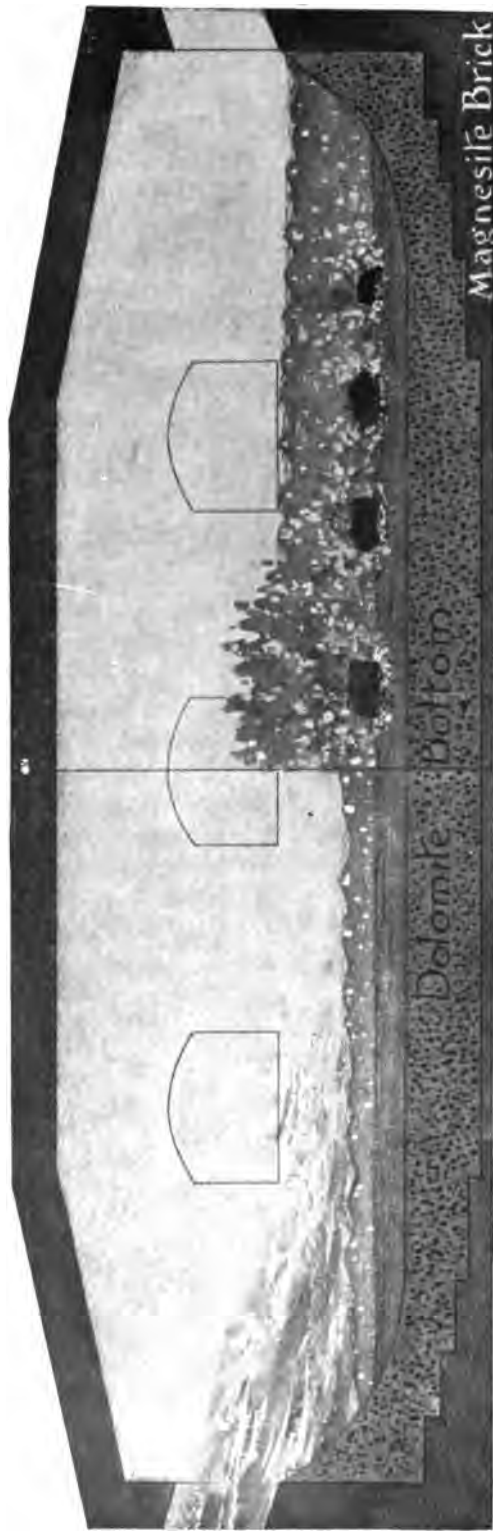

Fig. 97. The Open-hearth Process.

ebullition has nearly ceased, is shown in the left-hand part of this sketch. Naturally we have to draw somewhat upon our imagination for our conception of what takes place within an opaque mass like this.

Phosphorus also, like carbon, silicon and manganese, may be oxidized by means of iron oxide, forming phosphoric acid, which separates from the molten metal and combines with lime, iron oxide and other bases in the molten slag. Phosphoric acid, however, is here so unstable that it tends strongly to be again deoxidized as fast as it is formed, by the carbon and silicon of the molten iron beneath, or even by the molten iron itself, and, when so deoxidized, it immediately reunites with that iron, so that in effect dephosphorization is wholly prevented. This strong tendency to instantaneous and complete "rephosphorization" must be counteracted if the removal of phosphorus is to be effective, and to make that possible the slag must be made strongly retentive of phosphoric acid. But in order to be retentive of phosphoric acid, it must contain an excess of powerful bases, such as lime and iron oxide; for these, so long as they are in excess, form with the phosphoric acid salts so stable as to resist the deoxidizing action of the molten metal beneath.

Silica, or silicic acid, here plays the part of an acid so powerful that, if there is more than some 20 per cent of it in the slag, it enfeebles the hold of these bases on the phosphoric acid, with the result that much of this substance is reduced by the carbon, silicon or iron to phosphorus, and consequently reabsorbed by the molten metal. To exclude silica the furnace walls, which under other conditions are usually made of sand or clay, are here made either of a neutral substance, chromite (FeO , Cr_2O_3), or of a basic and yet infusible one, such as magnesia or the mixture of magnesia and lime which results from calcining dolomite (Ca , Mg) CO_3 . This, when mixed with some 10 per cent of dehydrated coal tar, is coked by the heat of the furnace into a hard ringed mass, which is much more resistant than a silicious lining, so that the basic process is actually easier to conduct than the older or "acid" process with its acid, *i. e.*, silicious, walls and slag. The basic variety has reached great importance in Germany, and in 1901 in the United States, 77 per cent of the total of open-hearth steel was made by it, though in Great Britain the proportion (in the first half of 1902) was only 13.6 per cent.

Furnaces, each treating a charge of fifty tons — five times the weight common in 1880 — have proved so economical that two of 70 tons' capacity have been built. No special difficulties have arisen in the use of these enormous furnaces. The gas and the air each enter the furnace through a single port, yielding a flame so great and long as to fill the whole melting chamber.

Many of these large furnaces are tilted at the end of each charge, as shown by the arrows in Fig. 100, so as to pour the molten steel into the casting-ladle, and the molten slag into its receptacle; thus the troublesome operation of pouring is brought under much better control. This and the other incidental advantages of tilting are much more important in the basic than in the acid process, but even in the former case it is not generally conceded that the tilting system has yet been so perfected that its advantages considerably outweigh its greater cost for installation and repairs.

276. THE SIEMENS FURNACE. — Figs. 98 to 101 are intended to explain not only the tilting furnace, but the general principle of the Siemens furnace. The charge of metal is melted and brought to the desired composition and temperature in the working chamber or body of the furnace, *G*, a long quasi-cylindrical vessel of brickwork, heated by burning within it preheated gas with preheated air. This working chamber is the furnace proper, in which the whole of the open-hearth process is carried out, and the function of all the rest of the apparatus, apart from the tilting mechanism, is simply to preheat the air and gas, and to lead them to the furnace proper and the products of their combustion thence to the chimney.

How this is done may be understood more easily if Figs. 98 and 99 are regarded for the moment as forming a single diagrammatic figure instead of sections in different planes. The unbroken arrows show the direction of the incoming gas and air, the broken ones the direction of the escaping products of their combustion. The air and gas, the latter coming from the gas producers or other source shown at the left of Fig. 99, arrive through *H* and *J* respectively, and their path thence is determined by the position of the reversing valves *K* and *K'*. In the position shown in solid lines, these valves deflect the air and gas into the left-hand pair of "regenerators," the air into and through the extreme left-hand regenerator, the gas into and through that immediately on its

right. Before considering the further path of the gas and air let us turn aside for the moment to ask what these regenerators are.

The Regenerators. It is for the purpose of highly preheating the air and gas before they mix and burn that they are passed separately into and through these regenerators. These are large rectangular chambers, in each of which is a great mass of "checkerwork," *i. e.*, firebricks piled loosely in such a way as to leave abundant free but zigzag passage for the passing air or gas, and by this very act to cause the air and the gas separately to come during their passage into extensive contact with the preheated surfaces of this checkerwork. How this preheating is done we shall shortly see; suffice it for the moment that the gas and air are separately exposed in them to an enormous extent of roughened and highly preheated firebrick surface, so that in this passage the gas becomes heated very highly, say to a light yellow heat, 1100°C . (2012°F .), in one regenerator, and the air simultaneously becomes highly heated in the other.

Let us now return to the itinerary of the gas and air, which we have now followed as far as the left-hand pair of regenerators, which in the present phase are the inlet regenerators. The gas and air next ascend, still as two separate streams, through the uptakes (Fig. 101), and they first mix at the moment of entering the working chamber through the ports L and L' (Fig. 98). As they are so hot at starting, their combustion of course yields a very much higher temperature than if they had been cold before burning, and they form an enormous flame, which fills the great working chamber. The products of combustion are sucked by the pull of the chimney through the farther or right-hand end of this chamber, out through the right-hand ports which in this phase are the exit ports, as shown by the dotted arrows, down through the right-hand pair of regenerators, heating to perhaps 1300°C . the upper part of the loosely-piled masses of brickwork within them, and thence past the valves K and K' to the chimney-flue O .

During this phase the incoming gas and air have been withdrawing heat from the left-hand regenerators, which have thus been cooling down, while the escaping products of combustion have been depositing heat in the right-hand pair of regenerators which have thus been heating up. After some thirty minutes this condition of things is reversed by turning the valves K and K' 90° , into the positions shown in broken lines, when they deflect

the incoming gas and air into the right-hand regenerators, so that they may absorb in passing the heat which has just been stored there; thence they pass up through the right-hand uptakes and ports into the working chamber, where as before they mix, burn, and heat the charge. Thence they are sucked out by the chimney-draught through the left-hand ports, down through the uptakes and regenerators, here again meeting and heating the loose mass of "regenerator" brickwork, and they finally escape by the chimney-flue *O*. After another thirty minutes the current is again reversed to its initial direction, and so on.

Fig. 98. Section on *EF* through Furnace and Port Ends.

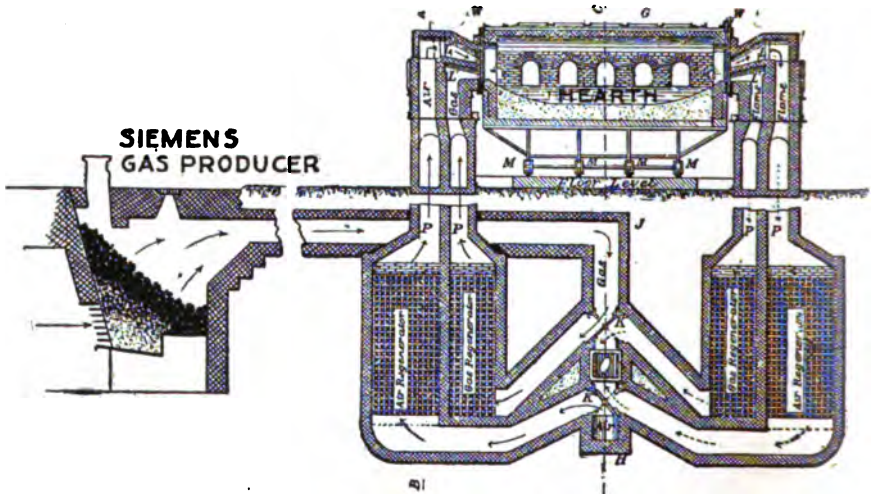

Fig. 99. Plan through Regenerators, Flues and Reversing Valves.

These regenerators are the essence of the Siemens or "regenerative furnace"; they are heat-traps, catching and storing by their enormous surface of brickwork the heat of the escaping products of combustion, and in the following phase restoring the heat to the entering air and gas. At any given moment one pair of regenerators is storing heat, while the other is restoring it. As devised by Siemens, the whole furnace was stationary. But H. H. Campbell and later S. T. Wellman have modified it by making the furnace proper, the part *WW* (Fig. 98) which contains the working chamber, movable, so that it tilts approximately around its own axis, somewhat like a barrel rolling on the floor.

In H. H. Campbell's system, which is here shown, the tilting working chamber is connected with the stationary ports L and L' by means of the loose water-cooled joint W . The furnace, resting on the rollers M , is tilted by the hydraulic cylinder N (Fig. 100). The slag-pockets P (Fig. 101), below the uptakes, are provided to catch the dust carried out of the furnace proper by the escaping products of combustion, lest it enter and choke the regenerators.

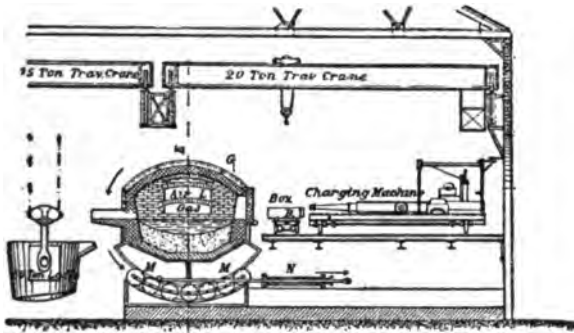

Fig. 100. Section on CH through Body of Furnace.

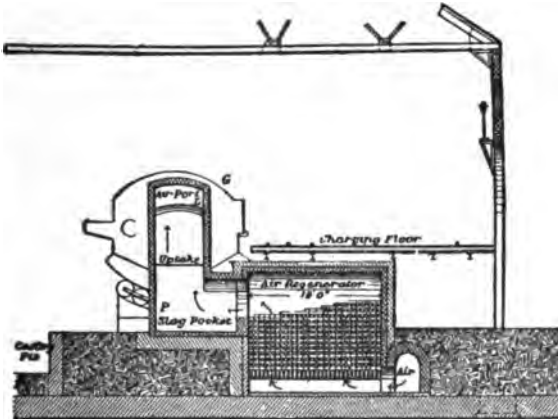

Fig. 101. Section on AB through Up-take, Slag-pocket and Regenerator.

Figs 98 to 101. Diagrammatic Sections of Tilting and Siemens Furnaces.

Legend: G , furnace body; H , air supply; J , gas supply; K , air reversing valve; K' , gas reversing valve; L , air port; L' , gas port; M , rollers on which the furnace tilts; N , hydraulic cylinder for tilting the furnace; O , flue leading to chimney; P , slag pockets; R , charging boxes; W , water-cooled joints between furnace proper, G , and ports L , L' .

Wellman's tilting furnace rolls on a fixed rack instead of on rollers. About 37 of these Wellman's rolling furnaces have been built and are in operation, and their capacity is from 3 to 70 tons at a time. Their production for a day of twenty-four hours would thus lie between 15 and 100 tons each. The numbers just given include two 70-ton furnaces for the Talbot process. A Wellman furnace to hold 200 tons at a time for this process has been proposed, but the advantages of such extreme size are open to question.

In the Wellman charging system the metal is packed by unskilled laborers in iron boxes, *R* (Fig 100), standing on cars in the stockyard. A locomotive carries a train of these cars to the track running beside a long line of open-hearth furnaces. Here the charging machine lifts one box at a time from its car, pushes it through the momentarily opened furnace door, and empties the metal upon the hearth of the furnace by inverting the box, which it then replaces on its car.

277. NEW VARIETIES OF THE OPEN-HEARTH PROCESS. As pointed out briefly in § 265 cast iron differs from steel essentially in containing more carbon and silicon, and often more phosphorus; and the open-hearth process converts molten cast iron into molten steel either (1) by diluting its carbon and silicon by additions of scrap steel or wrought iron (*pig and scrap process*); or (2) by oxidizing its carbon and silicon, jointly by means of the oxidizing flame of the Siemens furnace, and of iron oxide added in the form of ore or scale (*pig and ore process*); or (3) by both means jointly. Because ore is usually much cheaper than scrap iron, the pig and ore process would usually be the cheaper, were it not that it must be conducted very slowly, lest the frothing due to the escape of the carbonic oxide gas, which results from the oxidation of the carbon of the metal, cause the charge to overflow. Rapid decarburization with its consequence, violent ebullition, is permissible in the Bessemer process, which lasts only as many minutes as the open-hearth process lasts hours, because the Bessemer converter is so deep that the metal is not liable to boil out of it. Further, the cold iron ore of the pig and ore process can be introduced only very slowly, lest it chill the molten metal, both directly and because its reaction on the carbon absorbs heat; this local cooling indeed is what aggravates the frothing. A cold lump of ore chills the slag immediately around it, just where its

oxygen reacting on the carbon of the metal generates carbonic oxide; the slag becomes cool, viscous, and of a consistency leading to extreme frothing on slight provocation, just where the provocation to frothing is extreme through the local evolution of gas.

We will now look briefly at three new modifications of the open-hearth process, the Bertrand-Thiel, the Talbot, and the Monell.

278. **THE BERTRAND-THIEL PROCESS.** — Bertrand and Thiel oxidize the carbon of molten cast iron by running it upon a charge of preheated but usually still solid scrap steel on the hearth of an open-hearth steel melting furnace. In this preheating the surface of the individual pieces of scrap steel has become much oxidized. When the molten cast iron is run upon it, the scrap steel quickly melts and coalesces with the cast iron: and both during and immediately after fusion the oxygen of the former is in a position to attack the carbon of the latter efficiently. The reaction between the oxygen of one and the carbon of the other is therefore extremely rapid because it occurs throughout their depth, whereas in common procedure oxidation occurs only at the upper surface of the bath of cast iron at its contact with the overlying slag. Moreover, since local cooling, with its consequent viscosity and tendency to froth, are avoided, the frothing is not excessive in spite of the rapidity of the reaction.

279. **THE TALBOT PROCESS.** — To enlarge the scale of operations makes strongly for economy in the open-hearth process as in other high temperature ones. (See below.) Yet the use of an open-hearth furnace of very great capacity, say of 75 or of 100 tons per charge, has the disadvantage that such very large lots of steel, delivered at relatively long intervals, are less readily managed in the subsequent operations of soaking and rolling down to the final shape, than smaller lots delivered at shorter intervals. To meet this difficulty Mr. B. Talbot carries on the process as a quasi-continuous instead of an intermittent one, operating on 70-ton lots of cast iron in such a way as to draw off part of the resultant steel in 20-ton lots at relatively short intervals, and charging a fresh 20-ton lot of cast iron to replace each lot of steel thus drawn off. Besides minor advantages, this plan has the merit of avoiding an ineffective period which occurs in common open-hearth procedure just after the charge of cast iron has been melted

down. At this time the slag is temporarily rich in iron oxide and silica, resulting from the oxidation of the iron and of its silicon which occurs as the charge slowly melts and trickles down. Such a slag not only corrodes the furnace lining but also impedes dephosphorization, because it is irretentive of phosphorus. Further, the relatively low temperature impedes decarburization. Clearly, no such period can exist in the continuous process.

280. THE MONELL PROCESS. At a relatively low temperature, say 1300° C., the phosphorus of cast iron oxidizes and is removed much faster than its carbon, while at a higher temperature, say 1500° C., carbon oxidizes in preference to phosphorus. It is well to remove this latter element early, so that when the carbon shall have fallen to the proportion which the steel is to contain, the steel shall already be free from phosphorus and so ready to cast. In common open-hearth procedure, although the temperature is low early in the process, *viz.*, at the end of the melting down, dephosphorization is then impeded by the temporary acidity of the slag, as just explained. At the Carnegie works Mr. Monell gets the two dephosphorizing conditions, low temperature and basicity of slag, early in the process, by pouring his molten but relatively cool cast iron upon a layer of preheated lime and iron oxide in the open-hearth furnace.

Because of these two conditions so favorable to dephosphorization, the removal of the phosphorus from the metal to the slag is actually very rapid. At the same time the ebullition from the formation of carbonic oxide gas, by the oxidation of the carbon, is so strong that it puffs up the resultant phosphoric slag enough to make most of it run out of the furnace, thus both removing the phosphorus permanently from danger of being later deoxidized and returned to the steel, and partly freeing the bath of metal from the heat-insulating blanket of slag. Yet frothing is not excessive, because the slag is not, as in common practice, locally chilled and made viscous by cold lumps of ore.

281. THE BESSEMER PROCESS. — The chief advances in the Bessemer process have been the use (1) of molten cast iron direct from the blast-furnace, or "direct metal"; (2) of "mixers" in which the cast iron from several blast-furnaces is mixed together, so as to equalize its composition; (3) of "car-casting," or casting the molten steel in moulds standing on a train of cars. In addition to these, which are advances not in the nature but in the adminis-

tration of the process; (4) the basic Bessemer or Thomas process has come into extensive use.

282. DIRECT METAL AND THE MIXER. — Until lately the cast iron for the Bessemer process has nearly always been allowed to solidify in pigs, which were next broken up by manual labor, and remelted at great cost. It has long been seen that there should be a great saving if this remelting could be avoided, and "direct metal," *i. e.*, the molten cast iron direct from the blast-furnace, be treated in the Bessemer process. The obstacle is that, owing to unavoidable irregularities in the blast-furnace process, the silicon and sulphur-content of the cast iron vary to a degree and with an abruptness which the Bessemer process can hardly tolerate.

Sulphur, which is not removed in the acid Bessemer process, *i. e.*, the Bessemer process in its original form, injures the steel so greatly that it must be held below a limit, fixed in each case by the uses to which the steel is to be put. Further, the point at which the process should be arrested is recognized by the appearance of the flame which issues from the converter's mouth, and variations in the silicon-content of the cast iron treated alter this appearance, so that the indications of the flame become confusing, and control over the process is lost. Moreover, the quality of the resultant steel depends closely on the temperature of the process, and this in turn depends upon the proportion of silicon, the combustion of which is the chief source of the heat developed. Hence the importance of having the silicon-content constant. This was brought about at the Carnegie "Edgar Thomson" works by Captain W. R. Jones's invention of the "Mixer," which is simply a great reservoir into which successive lots of molten cast iron from all the blast-furnaces available are poured, forming a great molten mass of some two hundred or more tons. This is kept molten by a small flame playing above it, and successive lots of the cast iron thus mixed are drawn off, as they are needed, for conversion into steel by the Bessemer process.

This device not only makes the cast iron much more uniform, but also removes much of its sulphur by a curious slow reaction. Many metals have the power of dissolving their own oxides and sulphides, but not those of other metals. Thus iron dissolves its own sulphide freely, but not that of either calcium or manganese. Consequently, when we deoxidize calcium in the iron blast-furnace, it greedily absorbs the sulphur which has dissolved in the iron as

iron sulphide, and the sulphide of calcium thus formed separates from the iron and unites with the slag floating upon that iron. In like manner, if the molten iron in the mixer contains manganese, this metal unites with the sulphur present, and the manganese sulphide, relatively insoluble in the iron, slowly rises to the surface, and there reaching the air, its sulphur oxidizes to sulphurous acid, which escapes. The use of the mixer, and through it that of direct metal, has now become general.

There still remains some irregularity in the silicon-content of the cast iron, and consequently in the temperature developed in the process, but this is met by throwing into the converter, during the process itself, a variable quantity of cold scrap steel (the crop-ends of rails and other waste pieces), and also in the United States by introducing a variable quantity of steam into the air which is blown through the molten iron. This is decomposed, with great absorption of heat and consequent lowering of the temperature, affording a most convenient way of regulating the temperature. If the temperature threatens to be too low, it may be raised by so inclining the converter that the layer of metal through which the blast from certain of the tuyeres passes shall be so thin that here the blast shall oxidize much iron, which thus becomes a source of heat, though an expensive one.

283. THE CAR-CASTING SYSTEM deserves description chiefly because it shows how, when the scale of operations is as enormous as it is in the Bessemer process, even a slight simplification and a slight heat-saving may be of great economic importance.

Whatever be the form into which the steel is to be rolled, it must in general first be poured from the Bessemer converter in which it is made into a large clay-lined ladle, and thence cast in vertical pyramidal ingots, Fig 103. To bring them to a temperature suitable for rolling, these ingots must be set in heating or soaking furnaces (§ 293, p. 375). This should be done as soon as possible after the ingots are cast, both to lessen the loss of their initial heat and to make way for the next succeeding lot of ingots, a matter of great importance because the charges of steel follow each other at such very brief intervals. Two converters working together have made 4958 charges of ten tons each, or a total of 50,547 tons, in one month, or at an average rate of a charge every seven minutes and twenty-four seconds throughout every working day. It is this extraordinary rapidity that makes the process so economical and

determines the way in which its details must be carried out. Moreover, since the mould acts as a covering to retard the loss of heat, it should not be removed from the ingot until just before the latter is to be placed in its soaking furnace.



Fig. 102. The Car-casting System of F. W. Wood.

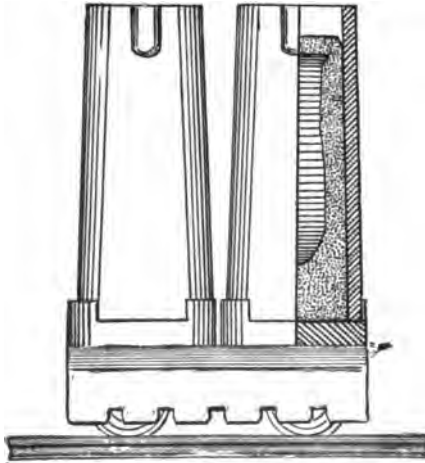

Fig. 103. Mould Car for the Car-casting System, Showing the Tapered Ingot inside the Mould.

These conditions are fulfilled by the car-casting system of Mr. F. W. Wood of Sparrows Point, Md., in which the moulds, while receiving the steel, stand on a train of cars (Figs. 102 and 103), which are immediately run to the side of the soaking furnace.

When any individual ingot begins freezing within its mould, it naturally freezes from without inwards; and the crust of solid steel gradually thickens and grows stronger as the freezing proceeds, Fig. 103. When this crust has grown so thick and strong that it can endure without collapsing the grip of the tongs needed to transfer the ingot to the soaking furnace, the tapered mould is withdrawn by lifting it from the tapered ingot which it encloses, and is set on an adjoining train of cars. The ingots are then charged directly into the soaking furnace. The mould-train now carries its empty moulds to a cooling yard, and, as soon as they are cool enough to be used again, carries them back to the neighborhood of the converters to receive a new lot of steel.

In this system there is for each ingot and each mould only one handling in which it is moved as a separate unit, the mould from one train to the other, the ingot from its train into the furnace. In the other movements, all the moulds and ingots of a given charge of steel are grouped as a train, which is moved as a unit by a locomotive.

In the early days of the Bessemer process the advantages which car-casting offered were recognized, and plans for carrying it out were proposed. But a very grave difficulty in the way of any such system was that, in pouring the steel from ladle to mould, more or less of it occasionally spatters, and these spatterings, since the steel as soon as it solidifies is extremely tenacious, if they strike the rails or the running gear of the cars, obstruct and befoul them, preventing the movement of the train. But this cannot be tolerated, because the economy of the process requires extreme promptness in each of its steps. This difficulty prevented casting upon cars. At that time, and indeed until the invention of Mr. Wood's car-casting system, the plan followed was much more expensive. The moulds stood not on cars, but directly on the floor of a casting pit while receiving the molten steel. When the ingots had so far solidified that they could be handled without having their crust break through, the moulds were removed and set on the floor to cool, the ingots were set on a car and carried to the heating furnace, and the moulds were then replaced in the casting pit. Here each mould and each ingot was moved as a separate unit twice, instead of only once as in the car-casting system; the ingots radiated away great quantities of heat in passing naked from the converting mill to the soaking furnaces, and the heat which they

and the moulds radiated while in the converting mill was not only wasted, but made this mill, open-doored as it was, so intolerably hot that the cost of labor there was materially increased.

The way in which Mr. Wood met the difficulty of spattering the tracks and running gear was a most simple one. It consisted, as shown in Fig. 103, in so shaping the cars that they completely protect both their own running gear and the track from all possible spattering, a device which, simple as it is, has materially lessened the cost of the steel and greatly increased the production.

283 A. INCREASE IN THE RATE OF PRODUCTION OF A PAIR OF BESSEMER CONVERTERS. — This is shown in Table 15.

TABLE 15. — *Maximum Production of Ingots by a Pair of American Converters, in gross Tons per Week.*

Year	Tons
1870	254
1880	3,433
1889	8,549
1899, for a month the average weekly production was . . .	11,233
1902	13,703
1903	15,704*

* World's record for two ten-ton converters.

Thus in thirty-three years the rate of production per pair of vessels has increased more than sixty fold.

The production of European Bessemer works is very much less than that of American. Indeed the whole German production of acid Bessemer steel in 1899 was at a rate but slightly greater than that here given for one pair of American converters for that year; and three pairs if this American rate was continued, would produce almost exactly as much steel as all the sixty-five active British Bessemer converters, acid and basic together, produced in 1899.

284. RANGE IN SIZE OF CONVERTERS. — In the Bessemer process, and indeed in most high-temperature processes, to operate on a large scale has, in addition to the usual economies which it offers in other industries, a special one, arising from the fact that from a large hot furnace or hot mass in general a very much smaller proportion of its heat dissipates through radiation and like causes than from a smaller body, just as a thin red-hot wire cools in the air much faster than a thick bar equally hot. Hence the progressive increase which has occurred in the size of converters, until now some of them can treat a 20-ton charge, is not surprising. But, on the other hand, when only a relatively small quantity of a

special kind of steel is needed, very much smaller charges, in some cases weighing even less than half a ton, have been treated with technical success.

This has been particularly true in the manufacture of steel castings, *i. e.*, objects usually of more or less intricate shape, which are cast initially in the form in which they are to be used instead of being forged or rolled to that form from steel cast originally in ingots like those of Fig. 103. For making castings, especially those which are so thin and intricate that, in order that the molten steel may remain molten long enough to run into the thin parts of the mould, it must be heated initially very far above its melting-point, the Bessemer process has a very great advantage in that it can develop a much higher temperature than is attainable in either of its competitors, the crucible and the open-hearth processes. Indeed, no limit has yet been found to the temperature which can be reached, if matters are so arranged that not only the carbon and silicon of the pig iron, but also a considerable part of the metallic iron itself, is oxidized by the blast; or if, as in the Walrand-Legenisel modification, after the combustion of the initial carbon and silicon of the pig iron has already raised the charge to a very high temperature, a still further rise of temperature is brought about by adding more silicon in the form of ferro-silicon, and oxidizing it by further blowing.

In the crucible and the open-hearth processes the temperature attainable is limited by the danger of melting the furnace itself, both because some essential parts of it, which, unfortunately, are of a destructible shape, are placed most unfavorably in that they are surrounded by the heat on all sides, and because the furnace is necessarily hotter than the steel made within it. But no part of the Bessemer converter is of a shape easily affected by the heat, no part of it has heat on more than one side, and the converter itself is necessarily cooler than the metal within it, since the heat is generated within the metal itself by the combustion of its silicon and other calorific elements. In it the steel heats the converter, whereas in the open-hearth and crucible processes the furnace heats the steel.

285. THE BASIC BESSEMER PROCESS. —The field of this process is greatly restricted by the facts (1) that it is more expensive than the normal or acid Bessemer process, especially as regards the repairs to the converter itself, (2) that at present it can be

applied only to pig iron which contains at least 1.80 per cent of phosphorus, and (3) that there are relatively few ores from which such pig iron can be made. In short it can be used only where cheap and phosphoric pig iron is at hand. Beyond this, it is better that the pig iron used should contain at least 1.80 per cent of manganese, and it should not contain more than 1 per cent of silicon or more than 0.12 per cent of sulphur; but these latter requirements can often be complied with.

Of the ores which contain enough phosphorus to yield pig iron suitable for this process the chief is the poor but very cheap "Minette" ore of the enormous deposits of Luxemburg and Lorraine, though Sweden also has deposits of phosphoric iron ore from which much is to be expected.

Eighty-six per cent of the German and Luxemburg Bessemer steel of 1899, and 28 per cent of the British, were made by the basic process, which is important also in Belgium and Bohemia. But in the United States few phosphoric ores are so much cheaper than the non-phosphoric or "Bessemer" ores as to permit the basic process to compete with the original or "acid" Bessemer process. While it has at one time or another been used at two American steel works regularly, and experimentally at others, it is not now in use in this country, nor does it seem likely to be in the near future.

The rôle of the 1.80 per cent of phosphorus needed in the pig iron is to generate, in being oxidized to phosphoric acid by the air blown through the metal, the very high temperature, about 1600° C. (2912° F.), which the process needs in order to raise the resultant steel above its very high melting-point, so that it may remain molten and because molten can be poured into its moulds.

Silicon cannot be used here as a chief source of heat, as it is in the "acid" Bessemer process, because the resultant silica would both corrode the basic walls of the converter, and cause "rephosphorization," as explained in § 275, p. 347, unless counteracted by great additions of lime, which would not only occupy precious room, but in themselves consume most of the heat generated by the oxidation of the silicon. Further, if the silicon is much in excess of 1 per cent, it causes such frothing as to throw much of the metal out of the mouths even of these roomy converters.

Manganese to the extent of 1.80 per cent is desired as a means of preventing the resultant steel from being redshort, *i. e.*, brittle at a red or forging heat.

The pig iron should be as nearly free as possible from sulphur, because the removal of any large quantity of this element in the process itself is both difficult and expensive, and because sulphur is so injurious that but little can be tolerated in the resultant steel.

The basic lining of the converters, made of calcined dolomite mixed with 10 per cent of dehydrated coal tar, is expensive, and lasts but relatively few charges—in few works more than 200 and in some only 100—while the silicious lining of the acid converter lasts thousands of charges. Hence, for the basic process, spare converters must be provided, so that there may always be some of them re-lining, either while standing in the same place as when in commission, or, as in Holley's arrangement, in a separate repair house, to which these gigantic vessels are removed bodily.

The slag of the process usually contains about 18 per cent of phosphoric acid, and on this account it is so valuable a fertilizer as to be a most important by-product. Its percentage composition is approximately as follows:

PHOSPHORIC ACID	SILICA	LIME	MAGNESIA	FERROUS OXIDE
16 to 19	6 to 9	50	3	13

In order that the phosphoric acid may be the more fully liberated by the humic acid, *etc.*, of the earth, a little silicious sand is mixed with the still molten slag after it has been poured off from the molten steel. The slag is used in agriculture with no further preparation, save very fine grinding.

286. DARBY'S RECARBURIZING PROCESS. — In the basic Bessemer process most of the phosphorus is not removed until after the carbon, probably because the lime, which is charged in solid lumps, melts and enters the slag so slowly that not until late in the operation does this slag itself, *i. e.*, the molten and effective part of the slag, become so basic as to be retentive of phosphoric acid. Hence in making steel rich in carbon it is not possible,

as in the acid Bessemer process, to end the operation as soon as the carbon in the metal has fallen to the point sought, but it is necessary to remove practically all of the carbon, then the phosphorus, and then "re carburize," *i. e.*, add whatever carbon the steel is to contain. On account of certain objections to adding this carbon in the form of cast iron, Darby adds gas-carbon, coke, or other carbonaceous matter, which is absorbed greedily by the molten steel. This process, which in careful hands yields regular results, is much used in connection with the basic open-hearth process, though indeed it can be used with either the acid or basic variety of the Bessemer and of the open-hearth process.

287. COMPARISON OF PROCESSES. — The puddling process, often preceded by the removal of silicon in the "refinery" process, is still widely used for making wrought iron for certain normal purposes which need great ease in welding; for purposes requiring special forms of extreme ductility which are not so confidently expected in steel; for miscellaneous purposes by many users, some ignorant, some very conservative; and for remelting in the crucible process.

All the best cutlery and tool steel is made by the crucible process, and indeed all for which any considerable excellence is claimed is supposed to be, though often incorrectly.

But the great mass of the steel of commerce is made by the Bessemer and the open-hearth processes. Open-hearth steel is generally thought better than Bessemer, and the acid variety of each of these two processes is thought to yield a better product than the basic variety. Probably this is not necessarily true, but the acid variety lends itself more readily to excellence than the basic. A very large proportion of the ores of the world cannot be made to yield cast iron either free enough from phosphorus for the acid Bessemer and the acid open-hearth processes, neither of which removes that most injurious element, or rich enough in phosphorus for the basic Bessemer process, which must rely on that element as its source of heat. But cast iron for the basic open-hearth process can be made from almost any ore, since its requirements, comparative freedom from silicon and sulphur, depend on the management of the blast-furnace rather than on the composition of the ore, whereas the phosphorus-content of the cast iron depends solely on that of the ore, since in the blast-furnace nearly all the phosphorus of the ore necessarily

passes into the cast iron. Thus the basic open-hearth process is the only one which can make merchantable steel, *i. e.*, steel containing less than 0.11 per cent of phosphorus, from cast iron containing more than 0.10 per cent but less than 1.80 per cent of phosphorus.

In cost of conversion the acid Bessemer process is the cheapest, the basic Bessemer next, and the basic open-hearth next, though the difference is not very great. Next in order of cost comes the acid open-hearth process. The crucible process, finally, is far more expensive than any of the others. Rail steel is almost always made by either the acid or the basic Bessemer process.

Between 1880 and 1901 the yearly production of open-hearth steel advanced in the United States from 9 to 53 per cent of that of Bessemer steel, and in Great Britain from 24 to 205 per cent. In the three great iron-making countries taken collectively, Great Britain, the United States, and Germany and Luxemburg, between 1880 and 1899 the production of acid open-hearth steel increased sevenfold, that of all open-hearth steel sixteenfold, that of the acid Bessemer process more than tripled, the total production of the Bessemer converter increased fourfold, the total production of steel fivefold, and the basic open-hearth and the basic Bessemer process, which were merely beginning to be used in 1880, in 1899 each produced about as much steel as the whole world produced by all processes in 1880. In these countries in 1899, 43 per cent of the total steel production was made by the acid Bessemer process, 20 per cent by the basic Bessemer, 16.5 per cent by the acid open-hearth, 18.5 per cent by the basic open-hearth, and a little over 1 per cent by the crucible and other processes.

Mechanical Treatment

288. DEFECTS IN STEEL INGOTS. — These are of three chief classes — pipes, blowholes, and segregation.

289. PIPES. — When molten steel is cast in an ingot in a cold cast iron mould, Fig. 103, its outer crust solidifies and cools as far as to be relatively rigid and incompressible, at a time, T , when much of the interior is still molten. In the further cooling the molten interior, because it is at this moment, T , so much

hotter than the exterior, has a greater range of temperature to pass through before becoming completely cold; and for this reason the interior will in cooling undergo more contraction than the exterior. But since the interior just filled the exterior at the moment T , it will not be large enough to fill it completely after it has undergone this excess of contraction. In particular, the interior undergoes much of this excess of contraction between the time T and the time T' when the last of the interior itself solidifies. Consequently at T' the solidifying interior no longer suffices to fill the outer crust; and on this account a deep pear-shaped contraction cavity or pipe is formed, as shown at C in Fig. 4, p. 5.

Since this pipe is due to the difference between the rate of contraction of the interior and that of the exterior, it may be lessened by retarding the cooling of the mass as a whole, because this in itself lessens the inequality of cooling. Further, the pipe



Fig. 104. Diagram Showing a Pipe so Situated as to Render most of the Length of the Ingot Unsound.

may be prevented from stretching down deep by retarding the solidification of the upper part of the ingot, as, for instance, by preheating the top of the mould, or by covering the ingot with a great mass of burning fuel or of molten slag. This keeps the upper part of the mass molten, so that it continues to flow down and feed the pipe during the early part of its formation in the lower and quicker-cooling part of the ingot. In making castings of steel, this same difficulty arises; and much of the steel founder's skill consists either in preventing these pipes, or in so placing them that they shall not occur in the finished casting, or at least not in a harmful position. In making armor-plates from steel ingots, as much as 40 per cent of the metal may be rejected because unsound from this cause. An ingot should always stand upright while solidifying, so that the unsound region due to the pipe shall be at its upper end, which may readily be cut off, leaving the rest of the ingot solid. If the ingot lay on its

side while solidifying, the pipe would occur as shown in Fig. 104 and nearly the whole length of the ingot would be rendered unsound.

Sauveur's process. To keep the top of the ingot molten during the solidification of the lower part, so that the molten metal at the top may run down and fill the pipe as fast as it forms, Prof. Sauveur connects a series of ingot moulds together in a long row, in such a way that the steel overflows from the first into the second, from this into the third, *etc.* Thus during the solidifying of the ingots at the beginning of the row, their upper part is kept molten by the steel which is flowing forward to fill those at the end of the row. In applying this method to the crucible steel process, a natural objection would be that, as different cruciblefuls are of different composition, this sweeping forward from mould to mould would tend to make each ingot heterogeneous in composition. This difficulty is to be met by mixing the several cruciblefuls in an appropriate vessel before the pouring proper begins.

290. BLOWHOLES. — Iron, like water and many other substances, has a higher solvent power for gases, such as hydrogen and nitrogen, when molten, *i. e.*, liquid, than when frozen, *i. e.*, solid. Hence in the act of solidifying it expels any excess of gas which it has dissolved while liquid, and this gas becomes entangled in the freezing mass, causing gas bubbles or *blowholes*, as at *A* and *B* in Fig. 4. Since the volume of the pipe represents the excess of the contraction of the interior between *T* and *T'*, any space within the ingot-crust occupied by blowholes must diminish by just so much the volume of the pipe, so that the more and larger the blowholes are, the smaller in general will the pipe be.

The position of blowholes is as important as their quantity. The interior surface of a blowhole which lies nearer the outer crust of the ingot, as at *A*, Fig. 4, is liable to become oxidized by the inward diffusion of the atmospheric oxygen, in which case it can hardly be completely welded later, since welding implies actual contact of metal with metal; it thus forms a permanent flaw. But deep-seated blowholes like those at *B*, Fig. 4, are relatively harmless, because the subsequent operation of forging or rolling usually obliterates them by welding their sides firmly together. Indeed, a slight porosity due to an incipient formation of blow-

holes is desirable in case of steel which is to be hammered or rolled, because but for such porosity a considerable shrinkage cavity or pipe forms in the axis of the ingot, which is thereby materially damaged.

Blowholes may be lessened or even wholly prevented by adding to the molten metal shortly before it solidifies either silicon or aluminium, or both; even as little as 0.002 per cent of aluminium is usually sufficient. An addition of manganese has a like effect. These additions seem to act in part by deoxidizing the minute quantity of iron oxide and carbonic oxide present, in part by increasing the solvent power of the metal for gas, so that even after freezing it can retain in solution the gas which it had dissolved when molten. But, since preventing blowholes increases the volume of the pipe, it is often better to allow them to form, but to control their position, so that they shall be deep-seated. In case of steel which is to be forged or rolled, this is done chiefly by casting the steel at a relatively low temperature, and by limiting the quantity of manganese and silicon which it contains.

Brinell finds that, for the conditions which are normal at his works at Fagersta, Sweden, if the sum of the percentage of manganese plus 5.2 times that of the silicon is as great as 2.05, the steel will be so completely free from blowholes as to have an undesirably large pipe. If this sum is 1.66, there will be just that small quantity of minute hardly visible blowholes which, while sufficient to prevent any serious pipe, is yet harmless. If this sum is less than 1.66, blowholes will occur and will be injuriously near the surface unless this sum is reduced to 0.28. He thus finds that this sum should be either about 1.66, so that the quantity of blowholes shall be harmlessly small; or as low as 0.28, so that they shall be harmlessly deep-seated.

These numbers must be varied with the variations in other conditions. In general either a higher casting temperature, or a smaller cross-section of the ingots or the use of hot or that of thin-walled moulds calls for a smaller quantity of silicon and manganese.

Brinell also finds that an addition of 0.0184 per cent of aluminium is approximately equivalent to the presence of manganese and silicon in the proportions $Mn + 5.2Si = 1.66$ per cent; *i. e.*, it unaided gives rise to structure *B* (Table 16). Naturally,

little or none of this aluminium remains in the steel. It oxidizes to alumina, which rises to the surface of the molten metal, or is found lining the walls of the pipe.

Table 16 and Figs. 105 to 111 give some of Mr. Brinell's results.

TABLE 16. — *Influence of Manganese and Silicon upon Blowholes and Pipes.*

NAME OF STRUCTURE	Mn + 5.2 × Si.	POSITION, ETC., OF BLOWHOLES	QUALITY OF THE STEEL AS REGARDS BLOWHOLES AND PIPES
	Per cent		
<i>A</i>	2.05	No blowholes, but a small pipe	Injured by the pipe.
<i>B</i>	1.66	No visible blowholes, no pipe	Just compact enough; excellent.
<i>C</i>	1.16	External blowholes, no pipe	Injured by the external blowholes.
<i>D</i>	.50	Fewer blowholes and somewhat deeper seated	Blowholes still harmfully near the surface.
<i>E</i>	.28	The blowholes are very deep seated	Excellent.
<i>O</i>	Cast too hot	Many external blowholes and a pipe	Injured by the external blowholes.
<i>H</i>	" " cold	Many blowholes both external and internal	Injured by the external blowholes.

The structures *O* and *H* are those induced by too high and too low a casting temperature respectively. The steel which here has structure *O* would, if cast at normal temperature, have had structure *A*. It is thought that the reason why the excessively high temperature causes these external blowholes is that it causes the carbon of the molten steel to react on the iron oxide on the surface of the mould, with the formation of carbonic oxide gas, which itself forms these blowholes.

Mr. Brinell finds it difficult,* for good reasons, to decide what structure the steel which here has structure *H* would have had if cast at normal temperature.

The foregoing refers to steel cast in ingots to be later rolled or hammered, so that there is an opportunity for welding up deep-seated blowholes. In case of steel castings, *i. e.*, steel objects

* Private communication, December 31, 1902.



Fig. 105.

Structure *A*. No blowholes but a small pipe. The ingot is injured by the pipe.
Mn + 5.2Si = 2.05 per cent.



Fig. 108.

Structure *D*. Fewer blowholes and somewhat deeper-seated. Blowholes still harmfully near the surface.
Mn + 5.2Si = 0.50 per cent.



Fig. 106.

Structure *B*. Excellent. Neither visible blowholes nor pipe. Just compact enough. Mn + 5.2Si = 1.66 per cent.



Fig. 109.

Structure *E*. Excellent. The blowholes are very deep-seated.
Mn + 5.2Si = 0.28 per cent.



Fig. 107.

Structure *C*. External blowholes; no pipe. The ingot is injured by the external blowholes.
Mn + 5.2Si = 1.16 per cent.



Fig. 110.

Structure *O*. Many external blowholes and a pipe. The ingot is injured by the external blowholes. Cast at too high a temperature. Had the temperature been normal the structure would have been *A*.

cast in their final shape, and therefore not subsequently forged or rolled, there is no such opportunity for closing up blowholes. The conditions therefore should be such that the blowholes shall neither be externally visible and thus disfiguring (not to say liable to easy detection), nor so placed as to weaken the casting seriously; and in general even the deep-seated blowholes are objectionable. Further, the casting temperature often has to be very high, in order to permit the steel to fill the intricacies of the mould before freezing.

Besides the foregoing elements, temperature, composition, *etc.*, which affect blowholes, moisture in the moulds tends to cause



Fig. 111.

Structure H. Many external blowholes and a ring of internal blowholes. Cast at too low a temperature.

serious external blowholes, and this is one serious difficulty in the way of using moulds of "green," *i. e.*, moist or unbaked sand for making steel castings.

291. SEGREGATION. (See §§ 76 and 77, pp. 86 and 87.) — The solidification of a large ingot of steel takes place gradually from without inwards, and each layer in solidifying tends to expel into the still molten interior the impurities which it contains, especially the carbon, phosphorus, and sulphur, which by this process are in part concentrated or *segregated* in the last freezing part of the ingot. This is in general around the lower part of the pipe, so that here is a second motive for rejecting the piped part of the ingot. While segregation injures the metal here, often fatally, by giving it an indeterminate excess of phosphorus and sulphur, it clearly purifies the remainder of the ingot, and

on this account it ought, under certain conditions, to be promoted rather than restrained.

The following is an extreme case of segregation:

	CARBON	SILICON	MANGANESE	PHOSPHORUS	SULPHUR
Composition of the initial metal per cent	0.24	0.336	0.97	0.089	0.074
Composition of the segregation	1.27	0.41	1.08	0.753	0.418

292. "DRAFT" FLUID COMPRESSION OF STEEL INGOTS.* — In the common or Whitworth method of closing the pipes and blow-holes in a steel ingot by strong pressure applied to it while solidifying, this pressure is applied to the top of the cylindrical ingot. If undisturbed the ingot would contract both longitudinally and transversely during and because of its cooling, and the mould would simultaneously expand because of its heating through the heat which it receives from the ingot. The transverse contraction of the ingot draws it away from its mould and the transverse expansion of the mould draws it away from the ingot. There is thus a double tendency to leave the sides of the ingot unsupported by the walls of the mould. The Whitworth system compresses the ingot lengthwise and shortens it and bulges it enough to compensate both for the lengthwise and transverse contraction of the ingot and for the expansion of the mould. In thus bulging, the ingot acts like a cylinder of soft india-rubber in part, but only in part. For in passing from the molten to the solid state the metal passes through an intermediate mushy state, when it has already lost the mobility of the molten state, and has not yet acquired the ductility of the solid state. It is while passing through this state that metallic castings tend to pull themselves asunder, and in this stage our bulging ingot tends to act like an unhooped barrel strongly compressed lengthwise, and to crack lengthwise as the staves of our barrel yawn apart. This splitting, doubtless, lessens very greatly the power needed for compressing the ingot, for the shell of the ingot when thus split should

* Extract from a contribution by the author to the Report of the Commissioner-General for the United States to the International Universal Exposition, Paris, 1900, Vol. V.

offer much less resistance to lengthwise compression than it would if it were an unbroken annular column. A disadvantage of this is that, when these rifts open through the shell of the ingot, the still molten central metal near the axis of the ingot, which has been enriched in carbon and phosphorus by segregation, is forced through these rifts to the surface, where it forms longitudinal ribbons of composition different from the rest of the crust. But for this extrusion the segregated impurities would have remained in the axis. If they remained there permanently they would be relatively harmless for most purposes, because they would be so close to the neutral axis, and in many cases they would be removed when the compressed ingot was finally bored out along its axis. In short, the bulging of the ingot leads to cracking, which is beneficial in that it lessens the power needed for compression, but harmful in that it allows the extrusion of the segregated axial metal. And this bulging is due to the tendency of the ingot to shrink away from its mould.

This drawing away and its consequences are avoided by the St. Etienne "draft-compression" process (*procédé de compression par tréfilage, Fonderies, Forges et Aciéries de Saint-Etienne, France*). In this process the ingot to be compressed is cast as the frustum of a slightly tapering cone, in a conical mould, and is then driven along this tapering mould by means of pressure applied to its base. Just as when we drive a tapered plug into a tapered hole the radial pressure against the sides of the hole is very great; so here the centripetal radial pressure of the sides of the mould against the walls of the ingot is very great; a moderate pressure applied to its base creates an enormous radial pressure along its sides, buckling them in and forcing the metal centripetally to fill up the pipe as fast as it tends to form.

A critical discussion of the relative merits of this system and those of Whitworth and S. T. Williams* would be beyond the scope of this work. But we may note that the draft-compression, if properly applied,† should avoid the extrusion effect

* United States patent 331856, December 8, 1885.

† I say if "properly applied," because if there is to be compression and therefore draft at the top of the ingot, the whole ingot must move bodily along through the mould, and if the draft at the top of the ingot is to equal that at the bottom, the walls of the mould must not only taper but must have a curved taper.

which is to be expected in the Withworth process, and also in the Williams process if applied to large ingots; and that it does not or should not need by any means so great a pressure applied from without to the end of the ingot as that required for the Whitworth system; for in the draft process the increase in the radial pressure due to the tapering should outweigh the increase of the resistance due, (1) to the tapering itself, (2) to the ingot walls remaining unbroken instead of splitting as in the Whitworth process, and (3) to the resistance of the solid base of the ingot to radial compression. But the pressure needed should be much greater than in the Williams system, which attacks the ingot in a most effective way.

293. HEATING FURNACES. — The introduction of the “soaking” or Gjers pit and the development of the continuous or Eckman type of furnace have been of great importance. When the outer crust of a large ingot in which a lot of molten steel has been cast has so far cooled that it can be moved without breaking, the temperature of the interior is still far above that suitable for rolling or hammering — so far above it that the surplus heat of the interior would more than suffice to reheat the now cool crust to the rolling temperature, if we could only arrest or even greatly retard the further escape of heat from that crust. Bringing such an ingot, then, to the rolling temperature is not really an operation of heating, because the average temperature of the ingot is already above the rolling temperature, but one of equalizing the temperature by allowing the internal excess of heat to “soak” through the mass. Gjers did this by setting the partly-solidified ingot in a well-closed “pit” of brickwork, preheated by the excess-heat of previous lots of ingots. The arrangement, shown in Fig. 112, has three advantages, (1) that the temperature of the ingot is here adjusted with absolutely no consumption of fuel; (2) that the waste of iron due to the oxidation of the outer crust of the ingot is very slight, because the little atmospheric oxygen initially in the pit is not renewed, whereas in a common heating furnace the flame brings a constant fresh supply of oxygen; and (3) that the ingot remains upright during solidification, so that its pipe is concentrated at its upper end, which can be cut off. (See § 289, p. 367.) In this form the system is rather inflexible, because if the supply of ingots is delayed the pits grow unduly cool, so that the next ensuing lot of

ingots either is not heated hot enough or is delayed too long in soaking. This defect is now usually remedied by heating the pits by the Siemens regenerative system (see § 276, p. 350); the greater flexibility thus gained outweighs both the cost of the fuel used and the increased loss of iron by oxidation by the Siemens gas flame.

The Gjers system is not applicable to small ingots or "billets,"* because they lack the inner surplus heat of large ingots; indeed, they are now allowed to cool completely before rolling. To heat these on the intermittent plan for further rolling, *i. e.*, to charge a lot of them as a whole in a heating furnace, bring

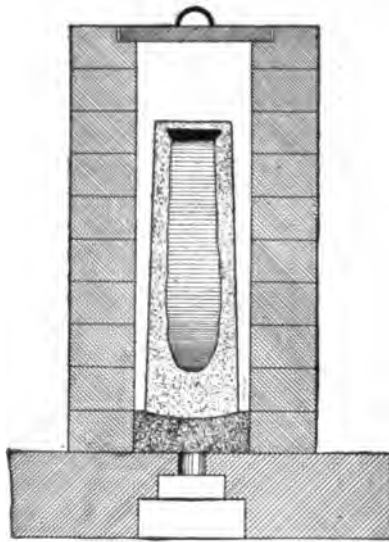

Fig. 112. Gjers Soaking Pit.

them as a whole to rolling temperature, and then withdraw them as a whole for rolling, is very wasteful of heat, because it is only in the first part of the heating that the outside of the ingots is cool enough to abstract thoroughly the heat from the flame; during all the latter part of the heating, when the temperature

* Billets are bars from 2 to 6 inches square, an intermediate product into which large ingots are rolled, to be further rolled into wire rods, sheets, small round and square rods, *etc.*

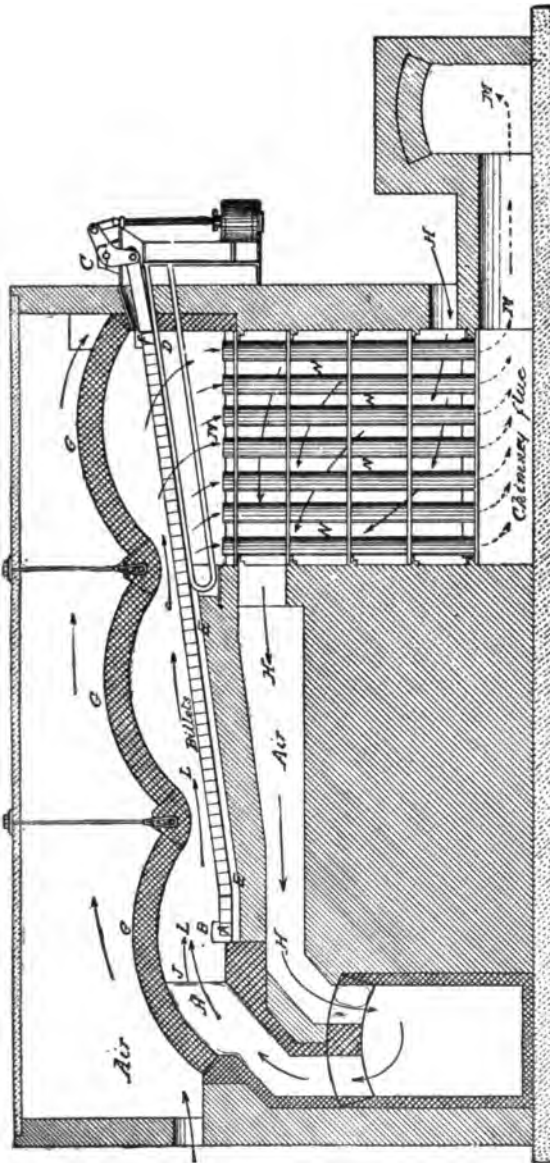

Fig. 113. Diagram of C. H. Morgan's Continuous Heating Furnace for 2-inch Billets 30 Feet long.

A, hottest billet ready for rolling; *B*, exit door; *C*, pusher for forcing billets forward; *D*, water-cooled pipe on which billets are pushed forward; *E*, magnesite bricks on which the hot billets slide forward; *F*, the billet last entered; *G*, the suspended roof; *H*, the incoming air preheated in *G* and by the pipes *N*; *J*, the incoming gas; *L*, the flame; *M*, the escaping products of combustion; *N*, pipes through which the products of combustion pass. In many of these recuperative furnaces, the products of combustion pass around the outside of the pipes, while the air to be heated passes through the interior of the pipes.

of the ingot has approached that of the flame, only an ever smaller part of the heat of that flame can be absorbed by the ingots. Hence in the intermittent system most of the heat generated within the furnace escapes from it with the products of combustion. The continuous heating system (Fig. 113), recovers that heat by bringing the flame into contact with successively cooler and cooler billets, *A — F*, and finally with quite cold ones, of consequently great heat-absorbing capacity.

As soon as a hot billet *A* is withdrawn by pushing it endwise out through the exit door *B*, the whole row is pushed forward by a set of mechanical pushers *C*, the billets sliding on the raised water-cooled pipes *D*, and, in the hotter part of the furnace, on the magnesite bricks *E*, on which iron slides easily when red-hot. A new cold billet is then charged at the upper end of the hearth, and the cycle begins by pushing out through *B* a second billet, and so forth. To lessen the loss in shape of "crop ends" and for general economy, these billets are in some cases 30 feet long, as in the furnace shown in Fig. 113. It is to make this furnace wide enough to receive such long billets that its roof is suspended, as here shown, by two sets of iron tie-rods.

As the foremost end of the billet emerges from the furnace it enters the first of a series of roll-trains, and passes immediately thence to others, so that before half of the billet has emerged from the furnace its front end has already been reduced by rolling to its final shape, that of merchant-bars, which are relatively thin, round, or square rods, in lengths of 300 feet.

In the intermittent system the waste heat can, it is true, be utilized either for raising steam (but inefficiently and inconveniently because of the intermittency), or by a regenerative method like Siemens; but this would probably recover less heat than the continuous system, first, because it transfers the heat from flame to metal indirectly instead of directly; and, second, because the brickwork of the Siemens system is probably a poorer heat-catcher than the iron billets of the continuous system; for when brickwork as a heat-catcher is compared with cold iron its disadvantages of low conductivity and low specific heat probably outweigh its advantages, roughness and porosity.

294. THE CONTINUOUS ROLLING-MILL. — The use of the continuous or Bedson type of rolling-mill has been much extended, so that it receives billets as large as 4 by $5\frac{3}{4}$ inches, and

rolls sheets, skelp, merchant-bars, cotton-ties, and other important products. In this system several roll-trains stand one behind another in column (as distinguished from the usual arrangement in line), so that the forward end of a given steel billet, which is under treatment, passes immediately from one pair of rolls into the next, and so on, and emerges from the last reduced to a diameter of say three-quarters of an inch, before the rear end of the same billet has entered the first pair of rolls, or indeed has emerged from the furnace in which it has been heated for rolling. By practically eliminating the loss of time between the successive reductions, large billets can be rolled at one operation into small rods of great length, so that the proportion of metal wasted in the form of crop ends is greatly reduced. Once the rod is so very thin as to be flexible, further reduction may be made by the Belgian system, in which the successive roll-trains stand in line instead of in column, and the front end of the rod as it emerges from one pair of rolls is turned 180° in a loop by hand or mechanism, and so returned to undergo another pass in the same train. By a combination of these two systems, as developed by C. H. Morgan and W. Garrett respectively, billets 3 inches square are rolled at one operation into bars three-quarters of an inch in diameter and about 230 feet long.

295. **HAMMERS AND HYDRAULIC PRESSES.** — The demand for very large forgings, especially for armor-plate and ordnance, has led to the erection of enormous steam-hammers. The falling parts of the largest of these, that at Bethlehem, Pa., weigh 125 tons. But even so great a hammer is an ineffective tool for making large forgings, chiefly because the effect of its blow is concentrated on the outside of the forging, and does not penetrate well towards the interior; indeed the days of large hammers seem to be over. The use of this particular one has been abandoned for that of an enormous hydraulic press which exerts a pressure of 14,000 tons. It is moved by water under a pressure of 7000 pounds per square inch, supplied by pumps of 16,000 horse-power. For forging shafting and other objects not readily made in rolling-mills, because their cross-section is not uniform, the hydraulic press seems to be firmly established as by far the most efficient tool. But though the great 14,000-ton Bethlehem press is used with great success for forging armor-plate also the cross-section of which is uniform, the rolling-mill certainly has special

merits for such a purpose, and with it all of Krupp's armor-plate is now made. The rolls of this great armor-plate mill are 4 feet in diameter and 12 feet long, and can receive an ingot 4 feet thick.

Statistics

296. **COST OF MANUFACTURE.** — There has been a remarkable reduction in the cost of iron and steel manufacture, a few examples of which, taken from American practice, are given in Table 17. Here we find a reduction of some 35 per cent in total cost and an even greater reduction in the cost of labor, reaching in one case even 54 per cent in a period of from seven to ten years. The reduction in the cost of labor has been brought about by improvements in administration and by mechanical appliances, and not by reduction of wages. According to Mr. Carnegie, in one of the largest American steel works the average wages in 1900 for all persons paid by the day, including laborers, mechanics, and boys, were more than \$4 a day for the 311 working days. How economical the methods of mining, transportation, and manufacture have become is shown by the fact that steel billets have sold at \$13.96 per ton, and in very large quantities at \$15 per ton, in the latter case, according to Mr. Carnegie, without further loss than that represented by interest, although the cost of each ton includes that of mining 2 tons of ore and carrying them 1000 miles, mining and coking 1.3 tons of coal and carrying its coke 50 miles, and quarrying one-third of a ton of limestone and carrying it 140 miles, besides the other items of expense in smelting the ore, converting the resultant cast iron into steel, and rolling that steel into rails.

Table 18 shows the reduction in prices. The price of wrought iron in Philadelphia reached \$155 in 1815, and, after declining to \$80, again reached \$115 in 1837. Bessemer steel rails sold at \$174 in the depreciated currency of 1868, at \$17 in 1898, and at \$28 in 1901. Note that these are extreme prices, while those in Table 18 are yearly averages.

297. **INCREASE IN PRODUCTION.** — In 1810 the United States made about 7 per cent, and in 1830, 1850, and 1860 not far from 10 per cent of the world's production of pig iron, though, indeed, in 1820 their production was only about one-third as great as in 1810. But after the close of the Civil War the production increased by leaps and bounds, till in 1901 it was nineteen times as

TABLE 17. — Reduction in Cost of Iron Manufacture in America — C. Kirchoff.

PLACE REPRESENTED	OPERATION REPRESENTED	PERIOD COVERED		COST, PROFIT AND PRODUCTION AT END OF PERIOD IN PERCENTAGE OF THAT AT BEGINNING OF PERIOD							
		From	To	Cost					Total excluding Raw Material	Profit per Ton	Production per Furnace, etc., per annum.
				Ore	Fuel	Labor	Total	Raw Material			
A large Southern Establishment	Manufacture of Pig Iron	1889	1898	79	64.1	51.9	63.4	—	47.9	167.7	
North-eastern District	"	1890	1898	103.7	97	61.1	65.8	—	33.9	163.3	
Pittsburg District	"	1887	1897	—	—	46	—	44	—	—	
Eastern District	Manufacture of Bessemer Steel Ingots	1891	1898	—	—	75	64.39	—	—	107	
Pittsburg	"	1887	1897	—	—	—	—	52	—	—	
Not stated	Rolling Wire Rods	1888	1898	—	—	—	63.6	—	—	375	

great as in 1865; and the percentage which it formed of the world's production rose to some 14 per cent in 1870, 21 per cent in 1880, and 34 per cent in 1899 and 1900. Between 1880 and 1901, though the British production increased only 21 per cent, that of the United States more than quadrupled, that of Germany and Luxemburg nearly tripled, and that of the whole world* more than doubled. The corresponding changes in case of steel are even more striking. The United States production in 1901 was nearly 1000 times that of 1865; and the proportion of the world's steel

TABLE 18. — *Reduction in Price of Certain Products.*

DATE	AVERAGE PRICE IN PENNSYLVANIA per ton of 2245 pounds			
	Wrought Iron	Iron Rails	Steel Rails	No. 1 Foundry Pig Iron
1800, January	\$100	—	—	—
1815, February	155	—	—	—
1824, November	80	—	—	—
1837, April	115	—	—	—
1850, Average	59.54	\$47.88	—	\$20.88
1865, "	106.38	98.62	\$158.50 *	46.12
1870, "	78.06	72.25	106.75	33.25
1880, "	60.38	49.25	67.50	28.50
1890, "	45.92	—	31.75	18.40
1898, "	23.97	—	17.62	11.66
1899, "	43.68	—	28.12	19.36
1900, "	48.16	—	32.29	19.98
1901, "	40.32	—	27.33	15.87

* 1868

which it formed rose from 3 per cent in 1865 to 10 per cent in 1870, 30 per cent in 1880, 36 per cent in 1890, and 38 per cent in 1900. Between 1880 and 1901 the production of Great Britain has increased to nearly four times, and that of the United States to nearly eleven times, their respective productions in 1880. As has been already indicated, of the combined wrought iron and steel of the United States, steel formed 2 per cent in 1865, 37 per cent in 1880, but about 85 per cent in 1899. The age of iron in these nineteen years gave place to the age of steel.

The *per capita* consumption of iron in Great Britain, excluding exports, has been calculated as 144 pounds in 1855, 250 pounds in 1890, and 292 pounds in 1900, that of the United States as

* This assertion as to the increase in the world's production is based on the production for 1900, because that for 1901 is not at hand.

62 pounds for 1850; 318 pounds for 1890, 387 pounds for 1900 and 464 pounds for 1901, or seven and a half times that of 1850. Among the chief causes of this increase in the consumption of iron by the human race we may recognize, in addition to the general advance in wealth and civilization, the increasing diversion of mankind from agricultural to manufacturing, *i. e.*, machinery-using, occupations — and nearly all machinery is necessarily made of iron; the displacement of wood by iron for ship and bridge building; the great extension of the use of iron beams, columns, and other pieces in constructing buildings of various kinds; the growth of steam and electric railways; and the introduction of iron fencing.

The increased importance of Germany and Luxemburg as producers of iron may be referred in large part to the invention of the basic Bessemer and open-hearth processes by Thomas, who by them gave an inestimable value to the phosphoric ores of these countries. That of the United States is due in part to the growth of its population; to the introduction of labor-saving machinery in iron manufacture; to the grand scale on which this manufacture is carried on; and to the discovery of the cheap and rich ores of the Mesabi region of Lake Superior. But given all these, the thousand miles which separate the ore fields of Lake Superior from the cheap coal of Pennsylvania would have handicapped the American iron industry most seriously but for the remarkable cheapening of transportation which has occurred. As this in turn is due to men of the class which developed the iron industry, it can hardly be questioned that, in further analysis, this development must in considerable part be referred to racial qualities. The same is true of the German iron development.

We may note with interest that the three great iron producers so closely related by blood — Great Britain, the United States, and Germany and Luxemburg — made in 1900 77 per cent of the world's pig iron and 79 per cent of its steel; and that the four great processes by which nearly all steel and wrought iron are made — the puddling, crucible, and both the acid and basic varieties of the Bessemer and open-hearth processes, as well as the steam-hammer and grooved rolls for rolling iron and steel — were invented by Britons (if we may count Sir C. W. Siemens as one), though in the case of the open-hearth process Great Britain must share with France the credit of the invention.

CHAPTER XII.—THE BLAST-FURNACE

298. THE BLAST-FURNACE is an enormous shaft, in many cases as much as 100 feet high and 25 feet maximum inside diameter. Its general form is shown in Fig. 89, p. 334, but the details of that form vary according to local conditions and more especially traditions.

The furnace is at all times full from top to bottom of a column consisting of coke or other fuel, limestone, and iron ore (Fig. 114, p. 386); though, as will be explained shortly, the lower part of this column consists of fuel only. The ore, flux, and fuel are charged through a hopper at the top of the furnace, and form a continuous column extending from the top to the bottom. Through openings called tuyeres at the bottom of the furnace a powerful blast of air, usually highly preheated, is introduced; this burns the fuel, thereby generating an intensely high temperature, sufficient to melt the ore, the iron of which has, by the time it has descended to this region, become reduced to the metallic state. Thus the whole column of solid materials descends slowly as its lower end is eaten away, the fuel which it contains being burnt away by the blast, and the rest of the material being melted away by the heat from the combustion of this fuel.

Some suggestion of this condition of things may be had from Fig. 114, which shows the lower part of the furnace. Above the "fusion level" are seen lumps of coke and other lumps of ore and of limestone (also shown here in lumps, but actually in powder); but shortly below that level no solid matter except the coke is shown, because at that level the temperature is so high that everything, except the coke, melts and runs down in drops to collect at the bottom of the furnace, somewhat as here sketched.*

* It would naturally be supposed that the lower end of the solid column of ore, coke and limestone would necessarily extend down through the molten iron and rest upon the very bottom of the furnace, being thus pressed down by the enormous weight of the column itself.

It is immaterial for our present purpose whether the coke extends down to the very bottom, or simply extends down and dips into the slag: in either case the coke is here in a position to exert an extremely powerful deoxidizing tendency upon the slag, and to carburize the molten iron

This sketch must be taken as diagrammatic only. In particular the ore and the lime (to which the original limestone has been changed during its descent) should be shown in powder instead of in lump form, for it is probable that neither ore nor lime remains in lump form in this part of the furnace, but that both have been burst into powder before they reach this level. This powdered state, however, I see no easy way of representing; indeed, the dynamic conditions in general which exist here, the violent uprush of gas and the true shape of the falling stream of molten material, are beyond my pictorial powers.

In addition to this descending column of solid material we have an ascending column of hot gases. The oxygen of the blast

energetically, as the latter trickles in fine streams over the column of coke between the fusion level and the pool of molten slag and iron.

It may not be amiss, however, to say that some metallurgists believe that the coke does not extend down through the molten iron, supporting their belief by calculations based upon the cubic contents of the hearth of the furnace, and the quantity of molten metal and slag which runs out at each tapping. Of course, if the coke extended down so as to rest upon the bottom of the furnace, it would occupy at least half the room in the hearth, and would diminish therefore very greatly the room available for storing the molten iron and slag. At first sight it seems improbable that the enormous weight of the solid column of materials should thus appear to hang in the air like Mahomet's coffin, without solid resting place. The common explanation that coke is lighter than molten iron and therefore cannot submerge in it, is incompetent. Wood is lighter than water; but if we had at the bottom of a blast-furnace a pool of water two feet deep, and filled the blast-furnace to the top with lumps of wood, the overlying wood would press the lower part of the column down into and through the water, so that it would rest on the furnace bottom.

But Mr. J. E. Johnson, Jr., offers an explanation which is certainly reasonable. It is as follows:

Part of the weight of the overlying column of materials is sustained by the friction of the walls, and especially by their jamming or scaffolding action; and most of the rest appears to be sustained by the friction of the upward-passing column of hot gases. The actual fall in the pressure of this column of gases in passing from the bottom to the top of the furnace is so great as to show that the friction of the passing gases does a large part of the work of supporting the column of solid materials. The case is somewhat like that of a gas blown through a porous plug.

It is thought not amiss to present this matter here, as indicating to the student the caution which must be used in speculating about the condition of affairs themselves invisible, even though at first sight they seem simple.

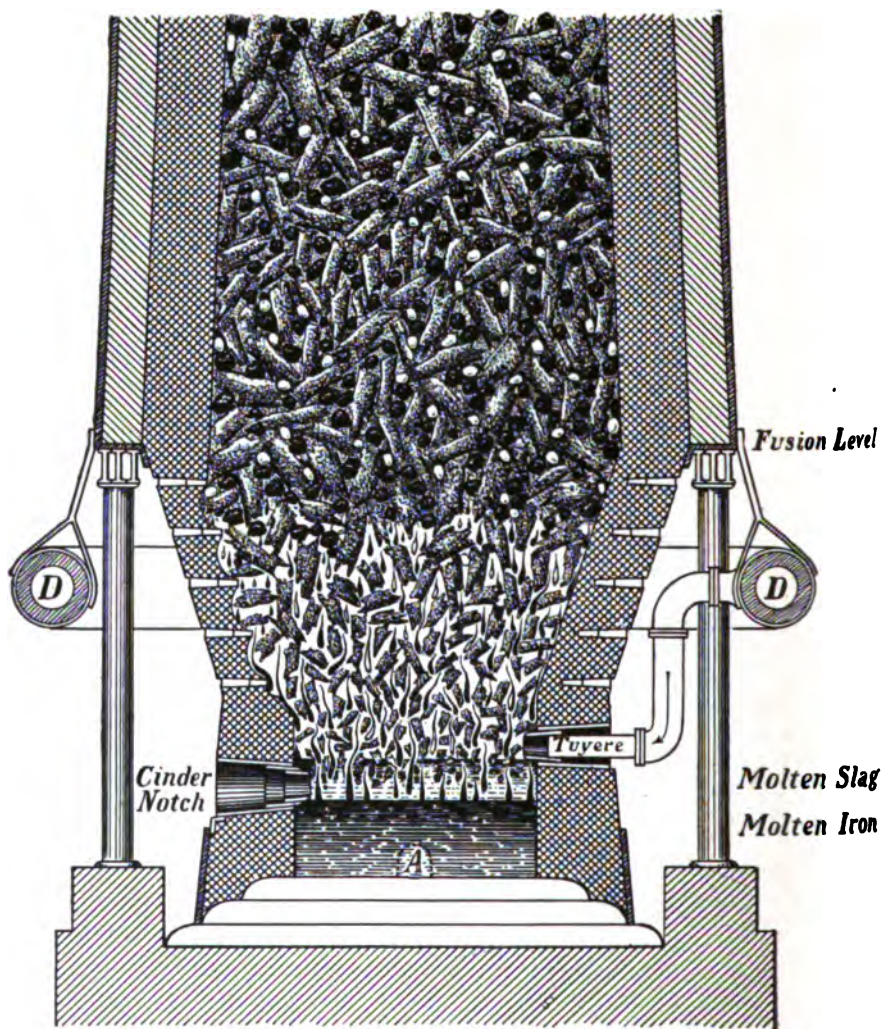







- Legend:-**
- Lumps of Coke ----- 
 - Lumps of Iron Ore ----- 
 - Lumps of Lime ----- 
 - Drops of Slag ----- 
 - Drops of Iron ----- 
 - Layer of Molten Slag --- 
 - Layer of Molten Iron --- 

Fig. 114. The Blast-furnace.

* Note as to Lump State. The ore and lime actually exist here not in lump form but in powder. They are shown in lump form simply because of the difficulty of presenting to the eye the powdered state.

introduced at the tuyeres is quickly converted into carbonic oxide by its reaction with the carbon of the fuel which it there meets. For our present purpose it is immaterial whether this conversion is a direct one by the reaction



or whether the carbon at first burns to carbonic acid by the reaction

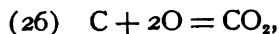

and this carbonic acid is immediately reduced to carbonic oxide by the coke which it meets, by the reaction

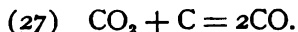

Suffice it that, very soon after entering the furnace through the tuyeres, the atmospheric oxygen has been converted into carbonic oxide, which, together with the atmospheric nitrogen of the blast, sweeps up through the furnace in enormous columns at great velocity. We must thus recognize two columns moving in opposite directions: a solid column of ore, flux and fuel descending very slowly, and a swiftly rising column of hot gases. Any given lump of the solid material passes through the furnace in about 12 to 15 hours, while any given particle of oxygen or nitrogen entering at the tuyeres passes through and quickly escapes at the top, its passage occupying probably only a small fraction of a minute.

The iron ore always contains beside iron oxide a considerable quantity of silicious or earthy material called gangue, and the fuel also contains a certain amount of ash. These materials, the gangue and the ash together with the lime of the limestone, unite to form a single molten mass, the slag, which floats on top of the molten iron. Two deep holes are provided at the lower end of the furnace, one, called the tap-hole, *A*, Fig. 114, at its very bottom for drawing off the molten iron at intervals; and the other, called the "cinder-notch" (Fig. 114), a very little above this, for drawing off the molten slag. These holes are closed with plugs of clay, except at the time when the molten materials are drawn through them.

While these two columns, the descending solids and the ascending gases, pass each other, and the hot gas is sweeping up swiftly, the initially cold, solid materials descending slowly, the

heat of the gaseous column is recovered by being transferred to the descending solids, so that, although the temperature of the gases in the neighborhood of the tuyeres is above 1600° C., the temperature of those which escape from the top of the furnace is only about 300° to 400° C. Owing to the fact that the fuel is burned in immediate contact with the solid materials which it is to heat, and that the products of its combustion are thoroughly cooled in their long upward travel in which they are exposed to cooler and cooler masses of descending solid materials, the thermal efficiency of the blast-furnace is very high.

299. CHIEF FUNCTIONS OF THE BLAST-FURNACE. — The ore consists of iron oxide plus silicious or earthy materials, *i. e.*, gangue. It is the duty of the blast-furnace:

- (1) to deoxidize the iron,
- (2) to carburize it,
- (3) to melt it,
- (4) to scorify the gangue, *i. e.*, to convert it into a fusible slag, and melt that slag,
- (5) to deliver the molten iron and slag as two separate masses.

To carburize the iron is essential, because it is an essential feature of the process that all its products shall be in a fluid condition, and the iron cannot be melted unless it is first carburized; or, if melted, it would not be sufficiently superheated beyond its melting-point to be readily cast into pigs, or transported in the molten state for further treatment.

The gangue of the ore consists of course of whatever minerals nature has placed there. The composition of the gangue varies greatly, but it rarely happens that it is suitable to the needs of the process. The ash of the fuel is also a part of the slag-making materials, and it further rarely happens that the composition of these two substances, gangue and ash, taken jointly is suited to the needs of the process.

Let me turn aside here to explain what is meant by "the needs of the process." In order that the process shall proceed properly, it is essential that the slag shall have certain physical and chemical properties; it must be of the proper fusibility, it must be rich in lime, it must be fluid enough to run out through the narrow aperture provided. Therefore the slag must have such a composition as will cause it to have these properties. Now it

rarely happens that the natural slag-making materials, *viz.*, the gangue of the ore plus the ash of the fuel, jointly have this suitable composition. Taken jointly, they generally have much less lime than such suitable composition requires. This natural deficit of lime is compensated for by adding to the charge a carefully pre-determined quantity of limestone (calcite, CaCO_3). A material thus added to give to the slag a proper composition is called a "flux."

Under these conditions when fusion sets in the three slag-making materials, gangue, ash, and lime of the flux, unite and form a single molten silicate, a silicate jointly of lime and of more or less magnesia and alumina. These are the slag-making materials, *i. e.*, these are the materials which, on fusion, will unite to form the slag, or in other words will scorify. The reason that they are is that they are the only oxidized bodies present in this region of fusion. When fusion takes place all oxidized bodies will unite into one mass, the slag; and this slag will reject from itself the molten iron as water rejects oil, because this is not an oxidized but an unoxidized body. With this molten metallic iron, moreover, will unite any other unoxidized substances present. Thus the molten iron will absorb any manganese, phosphorus and silicon which have been deoxidized and brought to the condition of metal or metalloid; and it will also absorb some of the carbon of the fuel, over which it runs on its way from the fusion level, at which it melts, to the hearth where it collects as a molten mass. But the molten iron appears to be capable of dissolving only a limited quantity of carbon. At least it does not appear to absorb much more than the 4 or 5 per cent of carbon which suffices to saturate the iron after it has solidified, although the conditions for such absorption seem excellent, in view of the extended contact of the fine streams of molten iron with the solid fuel over which they run in the lower part of the furnace.

The fact that the slag which results from the union of gangue, ash, and flux, forms a distinct and separate body from the molten iron, is in harmony with the general principle on which most metallurgical operations are based, that oxidized bodies in a state of fusion will not coalesce or unite with unoxidized ones.*

* If the student will run through in his mind the instances of chemical combination with which he is familiar, he will find this principle of wide application. Thus, on one hand he is familiar with the union of the

It is through this principle that most of our separations in metallurgy take place. Of the substances to be separated from each other, certain ones are brought to the unoxidized metallic (or metalloidal) state, the others remaining in an oxidized condition. On fusion the oxidized bodies in general coalesce into a single mass, and the unoxidized into another single mass. Like water and oil, these two masses reject each other and separate into two distinct layers, of which the oxidized one is generally the lighter and floats on top in the form of a slag or cinder.

This principle, of course, is not a universal law but simply a grouping together of certain important cases. A very important exception to this principle is that of sulphide of calcium, which although an unoxidized body, does not coalesce with the molten iron, but appears to dissolve in the slag, as we shall see.

common acids with the common oxides; and on the other hand with the union of the metals with each other to form alloys, especially of the metals with mercury to form amalgams, with sulphur to form sulphides, with phosphorus to form phosphides, with arsenic to form arsenides, and in some cases strikingly with carbon to form carbides, *etc.* Even the metals like platinum, which resist the attack of acids, unite readily with other metals and with metalloids. Platinum, though it is so resistant a material in the wet way, in the dry way in which it is exposed to other metals and to silicon (through the reducing action of carbon on silica) is in the highest degree destructible, *i. e.*, it alloys or combines readily with these unoxidized substances.

Of course these unions are not to be confounded with the reactions in the wet way between the metals themselves and oxidized bodies, such as acids and high metallic oxides. For these reactions are in general cases not of direct union, but of substitution. The metal replaces the hydrogen of the acid, and does not combine directly with the acid as such. Iron does not unite with sulphuric acid as such: it reacts upon sulphuric acid. Indeed from this present point of view, it is not the metal but an oxide of the metal which here enters into union, when the metal is attacked by an acid. It is iron oxide rather than iron which, from this point of view, enters into union and forms ferrous sulphate. Thus, of course, many oxidized bodies can react on unoxidized ones, and from such a reaction a union arises; but we may regard this union as itself between certain products of the reaction. In any given cases it will in general be true that the products which thus unite are either all oxidized, or all unoxidized. But when oxidized bodies (acids and metallic oxides, *etc.*) are brought together direct union habitually occurs, and substitution is by no means generally essential; and so, too, when unoxidized bodies (molten metals, or metals with sulphur or carbon) are brought together, there is habitually direct union, and substitution is not in general essential.

300. FUNCTIONS OF THE FUEL. — From what has gone before we see that the fuel has three functions:

- (1) To reduce the iron oxide to the metallic state.
- (2) To carburize the deoxidized iron and thus make it fusible.
- (3) To heat and melt both the metal and the slag-making substances.

The scorification of the gangue and ash require first flux to form with them a fusible compound of proper composition, and secondly fuel to heat and melt it.

301. CHEMICAL REACTIONS IN THE BLAST-FURNACE. REDUCTION OF THE IRON. — Very soon after the ore has entered the top of the furnace it becomes hot enough to be attacked by the carbonic oxide of the rising column of gas in which it finds itself immersed, and its iron is deoxidized by a reaction of which the following is a type:



But carbonic oxide is a feeble reducing agent. Indeed, if a polished knife blade is exposed at a red heat to carbonic oxide it is slightly blued, *i. e.*, superficially oxidized by that gas; and of course a gas which is capable of oxidizing iron itself is incapable of completely deoxidizing iron oxide. In point of fact deoxidization of the iron at or near the top of the furnace by the gas is incomplete, and it goes on only until an equilibrium between the four substances, (1) iron oxide, (2) the resultant iron, (3) carbonic oxide, and (4) the resultant carbonic acid (from reaction 18), has been reached or closely approached.

The conditions of this equilibrium doubtless vary with the temperature, but they never correspond to complete deoxidation. As the ore descends farther and farther, the ascending carbonic oxide which it meets has, of course, been less and less impoverished by the carbonic acid resultant from the above reaction: so that as the ore descends in the furnace the condition of the equilibrium progressively changes, and corresponds to more and more complete deoxidation. Nevertheless, at a certain and often rather short distance from the top, deoxidation nearly ceases.

On the other hand, as the rising gases approach the throat the successive layers of iron ore with which they come in contact have been less and less deoxidized, and therefore they carry the

oxidation of the carbonic oxide farther and farther. In other words the ratio

$$(28) \frac{\text{CO}_2}{\text{CO}} = M$$

progressively increases as the gases rise nearer and nearer to the top of the furnace. The higher this ratio the more completely is the carbon of the fuel utilized in the work of deoxidation, and this ratio is taken as a measure of the fuel efficiency of the furnace.

302. THE METALLURGICAL MANAGEMENT OF THE BLAST-FURNACE. — In considering this subject, instead of trying to consider all the matters which come under it, let us fix our attention carefully on certain of these, which are selected as showing the kind of considerations which the manager has to have in mind. Of course, his ulterior purpose must always be to make money for his employers; this he will try to do by a great variety of administrative measures which are beyond our present enquiry; and, as regards what we may call the metallurgical management, by making as much pig iron per diem as he safely can, by regulating carefully the composition of the pig iron, by using the smallest possible quantity of coke, *etc., etc.*

Our present enquiry will concern itself chiefly with the influence of certain important variables, which are under the manager's control, upon the composition of the pig iron, and more particularly upon the percentage of silicon and of sulphur which it contains. We will consider these variables chiefly as influencing the strength of the deoxidizing conditions, and through this the silicon and sulphur-content of the pig iron.

303. IMPORTANCE OF THE DEOXIDIZING TENDENCIES. — The great importance of this question of deoxidation is readily seen. We may look at it under several different aspects.

First, the importance of deoxidizing the iron of the ore completely is self-evident, since any iron not deoxidized would remain in the slag and would thereby be lost, for there is no ready means of recovering iron from the slag once this has escaped from the furnace.

But quite apart from the recovery of the iron itself, thorough deoxidation is important for another reason. The lining of the blast-furnace is made of fire-brick, which is essentially a silicate

of alumina. This fire-brick quickly becomes saturated with finely divided carbon deposited on it by means of the reaction :

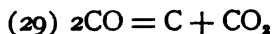

and but for this skeleton of carbon it is probable that the brickwork would quickly be destroyed by being melted away by the slag. A slag free from iron oxide has comparatively little action on fire-brick, at least when thus impregnated with carbon, and when cooled from without as the lower part of the furnace now always is. But if the slag contains any considerable quantity of iron oxide, as would necessarily be the case if the deoxidation of the iron was incomplete, this iron oxide oxidizes and so removes the carbon thus deposited in the brickwork by the reaction :

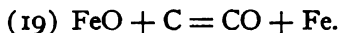

This leaves the brick itself naked to the slag. Such a slag quickly corrodes the brickwork, for the simple reason that iron oxide forms a very fusible compound with silica and alumina. Thus it happens that if the deoxidizing action of the furnace is insufficient, and a considerable amount of iron escapes deoxidation and passes into the slag, giving it the familiar black color of the ferrous silicates, this slag actually quickly corrodes the brickwork; and from this fact such a slag is called a "scouring cinder."

A further reason why the strength of the deoxidizing action is important, is that through it the manager is able to regulate the chemical composition of the resultant pig iron. In general, the stronger the reducing action the larger will be the proportion of silicon and the smaller will be the proportion of sulphur which that pig iron will contain.

Any increase of the strength of the reducing action will also tend to reduce more completely the phosphorus and manganese of the ore, and so to cause a larger proportion of these two elements to pass into the pig iron. These elements exist in the ore chiefly in the state of phosphoric acid, P_2O_5 , and manganic oxide, MnO_2 , and they can be deoxidized by reactions such as the following :

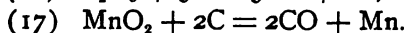
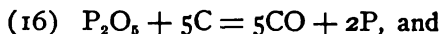

We need not, however, in our present study look at the effect of variations in the reducing action on the phosphorus and

manganese, for the reason that under the majority of conditions the blast-furnace manager regulates the manganese and phosphorus-content of his cast iron by regulating the quantity of these two elements which the ore itself contains, rather than through the variations of the management of the furnace. I do not here refer to the making of spiegeleisen or ferro-manganese, or other special kinds of cast iron, but to that of the common classes of cast iron which contain no very large quantity of manganese.

But when we come to the sulphur and silicon-content of the cast iron, this is something which the manager regulates to a very great extent by the manner in which he conducts the smelting operation. Of the silicon present in the ore as silica only a very small proportion in any event passes into the pig iron; but the variations in this proportion have the most profound effect upon the properties of the cast iron, and these variations are under the control of the manager so that from one and the same ore mixture he can make cast iron almost wholly free from silicon, or on the other hand cast iron containing much silicon.

So, too, by no means the whole of the sulphur present in the ore or fuel enters the cast iron, and of course the less the better. And by varying the management of the blast-furnace the manager is able to control to a very great extent the percentage of sulphur which does enter the cast iron.

The way in which the silicon-content of the pig iron is controlled is through controlling the deoxidation of the silica of the gangue and ash. This deoxidation takes place readily by reactions such as



and any silicon which is reduced is immediately absorbed by the molten iron present. Indeed, this reaction does not readily take place in the absence of iron; but if iron is present to absorb the resultant silicon the reaction is readily effected.

Thus, by controlling the strength of the deoxidizing conditions the manager can control the extent to which reaction (15) takes place, and thus the quantity of silicon which is formed, and thus finally the percentage of silicon which enters the pig iron.

We have already seen (§ 184, p. 208) that the presence of silicon favors the separation of carbon in the condition of graphite, and thus leads to the formation of gray cast iron. In short, for foundry purposes the presence of a certain amount of silicon, but

only a certain amount, is desirable. In the processes for converting cast iron into steel the quantity of silicon which that iron contains is in general a matter of first importance. On both these accounts then it is important to regulate the quantity of silicon which the cast iron is to contain, or in short to regulate the strength of the deoxidizing action, since it is this action that determines how much silicon shall be deoxidized and enter the iron.

While the sulphur-content, too, of the pig iron is regulated by the same general steps, yet the principle through which these steps work is strikingly different. There is no general agreement as to the theory of this operation, yet we may adopt as a working hypothesis that it is through influencing the degree of deoxidation that these steps regulate the sulphur-content, and that the way in which they influence it is through controlling the degree to which the following reaction takes place:

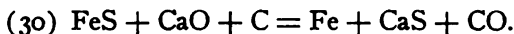

This reaction is clearly one of deoxidation; it is not, however, deoxidation of sulphur but of calcium, with the substitution of calcium sulphide for iron sulphide. How this substitution lessens the sulphur-content of the pig iron will now be explained.

The sulphur is initially present in the ore in the condition of sulphide of iron, and in most cases as pyrites, FeS_2 . One of the equivalents of sulphur of the pyrites is nearly or quite completely expelled by heat; but the second remains combined with the iron as FeS . It appears to be a general principle of wide application that metals are capable of dissolving small quantities and even in certain cases large quantities of their own oxides and sulphides, but that they have much less solvent power for the oxides and sulphides of other metals. Accordingly if the sulphur remained in the condition of iron sulphide it would dissolve in the cast iron, which would thereby be injured. We can prevent this by reaction (30), *i. e.*, by causing the sulphur to combine with calcium as calcium sulphide, which does not dissolve in the iron, but passes into the slag; and the thoroughness of desulphurization depends upon the degree to which this reaction takes place, *i. e.*, upon the extent to which calcium is deoxidized, and this depends in turn on the strength of deoxidation.

I am quite aware that this theory does not explain all the facts; but, in default of a better I give it as one which explains

a great many of them, and is consistent and intelligible. It appears to me probable that the further facts which this theory does not explain are due to some additional agency, and that the principle underlying this theory is probably a true one, but simply not the only principle which is at work.

We here notice this contrast. The amount of silicon, manganese and phosphorus which the cast iron will contain increases with the strength of the deoxidation; whereas the quantity of sulphur decreases with it. Deoxidation causes silicon, manganese and phosphorus to pass from the slag to the metal, but deoxidation of calcium causes sulphur to go into the slag instead of into the metal.

The effect of sulphur on the separation of graphite, and through this on the fracture or "grain" of the iron, is the opposite of that of silicon, opposing the formation of graphite and tending to make the iron white instead of gray. As respects both silicon and sulphur, then, the effect of the increase of the deoxidizing action on the formation of graphite is alike. In other words, strengthening the deoxidizing action favors the formation of graphite and makes the iron grayer, both through increasing the silicon-content and also through lessening the sulphur-content of the iron.

304. MEANS OF REGULATING THE STRENGTH OF THE DE-OXIDIZING ACTION. — Those which we will consider are the following:

- (1) Controlling the temperature in the hearth of the furnace.
- (2) Varying the proportion of fuel to "burden," *i. e.*, to ore plus limestone.
- (3) Varying the composition of the slag.

TABLE 19. — In order to keep before the reader in accessible form the results which we shall reach from time to time during the discussion which now follows, Table 19 has been prepared, presenting these results in an extremely condensed form. We are going to consider the effect of variations in the ratio of fuel to burden, in the blast temperature, and in the composition of the slag, on the silicon and sulphur-content of the pig iron. The influence of certain of these variations may be regarded as two-fold, a thermal influence and a direct chemical influence. For instance, the coke is both the heating and the deoxidizing agent. If we increase the proportion of coke, then, we both raise the tem-

perature, which in itself favors deoxidation, and we further favor deoxidation by providing more of the deoxidizing agent. Of these two we may call the former the thermal influence, the latter the direct chemical influence. The effect of the former is recorded in columns 2, 3 and 4, that of the latter in columns 5 and 6.

Column 2 gives the effect of each of the variables of column 1 on the hearth temperature, and columns 3 and 4, give the influence of this change of hearth temperature on the quantity of silicon and of sulphur which the pig iron will contain. As the discussion proceeds we will record the results we reach by means of plus (+) and minus (—) signs in the proper places in this table. For instance the fact that increasing the proportion of coke

TABLE 19

LINE	VARIABLE	INFLUENCE ON THE CAST IRON MADE									
		Effect on the Silicon and Sulphur-content						Effect on Graphite and Grayness			
		Thermal Influence			Direct Chemical Influence		Resultant of 3, 4, 5 and 6		By Silicon	By Sulphur	Net
		on Hearth Temperature	on Silicon-content	on Sulphur-content	on Silicon-content	on Sulphur-content	on Silicon-content	on Sulphur-content			
Column 1	2	3	4	5	6	7	8	9	10	11	
A	Increase in the ratio of fuel to burden	+	+	—	+	—	+	—	+	+	+
B	Increase in the Blast Temperature	+	+	—			+	—	+	+	+
C	Increase in the Lime-Magnesia-content of the slag = raising its melting-point	+	+	—	—	—	±	—	±	+	±

raises the hearth temperature we indicate by the plus sign (+) in column 2 line *A*. The fact that this elevation of hearth temperature will tend to increase the silicon-content of the pig iron we indicate by the plus sign (+) in column 3 line *A*, etc.

Column 9 gives the influence of the change in silicon-content in column 7 on the proportion of graphite and the grayness of the pig iron; column 10 gives the corresponding effect of the change in sulphur-content in column 8; and column 11 gives the resultant of the effects recorded in columns 9 and 10.

305. THE HEARTH TEMPERATURE. — The temperature of the hearth, *i. e.*, of the lowest part of the furnace, has a most important influence on the strength of the deoxidizing action; it is here that the deoxidation is to be finished, or in other words, it is here that its thoroughness is determined. The higher the temperature the more powerful the deoxidizing action of carbon on iron, silicon, calcium, manganese and phosphorus, and very likely on most other elements. Therefore the hotter the hearth is, the more powerful the deoxidizing action of the fuel there present, and the more silicon should be deoxidized and enter the iron, and the more calcium should be deoxidized and carry sulphur from iron to slag.

In short whatever tends to raise the hearth temperature tends thereby to raise the silicon-content and to lower the sulphur-content of the pig iron, a principle to which we shall have occasion to refer several times in the beginning of the following discussion.

The manager can raise the temperature of his hearth in three chief ways:

- (1) By increasing the proportion of fuel to ore and flux (*i. e.*, by lightening the burden).
- (2) By raising the temperature of the blast.
- (3) By making the slag more infusible.

That the first two should have this effect needs no explanation. We may, therefore, in Table 19, accept the plus mark (+) in lines *A* and *B*, column 2. Further, because raising the temperature here in and by itself favors deoxidation, and thereby tends to increase the silicon-content and decrease the sulphur-content of the pig iron, we may accept the plus signs in column 3 and the minus signs in column 4 of lines *A* and *B*. That increasing the proportion of coke charged should increase by direct chemical influence the strength of the reducing tendencies is perfectly clear for the reason that the fuel itself is the deoxidizing agent. And

as any increase in the strength of the deoxidizing tendencies should tend to increase the silicon-content and to decrease the sulphur-content of the pig iron, for reasons with which we are now so familiar, we accept the plus mark and the minus mark in columns 5 and 6 respectively of line *A*.

From the marks which we have now recorded in columns 3, 4, 5 and 6 of line *A* the marks in the remaining columns 7 to 11 of that line follow directly.

Thus the effect of an increase in the proportion of coke is to make the iron more graphitic and grayer in all the ways which we have considered.

We may for our present discussion assume that an increase in the temperature of the blast will have no direct chemical influence, apart from its thermal influence, or, at least we may ignore for simplicity in our present discussion any direct influence; hence, we leave blank columns 5 and 6 of line *B*. This done, the marks in the remaining columns 7 to 11 of line *B* follow directly from those of columns 2 to 4 of that line.

306. INFLUENCE OF THE SLAG MELTING-POINT ON THE HEARTH TEMPERATURE. — Why raising the melting-point of the slag should in and by itself directly raise the hearth temperature requires a word of explanation.

Let us suppose that on the right-hand side of a given blast-furnace as shown in Fig. 89, p. 334, we are charging a mixture, the slag-making materials of which are extremely infusible, whereas on the left-hand side we are charging a mixture, the slag-making components of which are relatively fusible. Let us further suppose, to illustrate our point, that these two charges descend separately without mixing up. Such a state of affairs of course could not exist, and it is imagined here simply for the purpose of explaining what does occur.

A given lot of ore, flux and fuel charged on the left-hand side gradually descends, becomes hotter and hotter, and finally, at the level *A*, Fig. 89, reaches such a temperature that the gangue, the ash of the fuel, and the lime of the limestone react on each other, unite, that is to say form a slag or *scorify*, melt, and run to the bottom of the furnace, where they collect as a layer of slag.

A parallel lot of charge on the right-hand side of the furnace gradually descends and grows hot in the same way. But when it has reached the point *A* at which the charge on the left-hand

side melted, that on the right-hand side still remains unmelted because the slag-making substances present as a whole are so much more infusible. At the temperature at which their fellows on the left-hand side of the furnace had reacted on each other, united, melted and formed slag, those on the right fail to react on each other and remain separate; and not until they have been heated to the distinctly higher temperature at which their interaction becomes possible, *i. e.*, not until they have descended much lower in the furnace, say to level *C*, will they in turn react, unite, scorfify, melt, and run to the bottom of the furnace.

Now, so long as solid materials descend through the furnace unmolten, their descent is slow, and they have abundance of time to acquire heat from the rising gases and from the fuel with which they are surrounded; in short, to acquire the temperature of the furnace level at which they are. But the moment they pass from the solid to the liquid state, instead of descending slowly they now run rapidly from the point at which they melt to the bottom of the furnace (see Fig. 114, p. 386); and during this rapid further descent, because of its rapidity, they have little further opportunity of acquiring heat. Hence the more fusible of the two lots will reach the bottom of the furnace at a temperature not greatly above its own melting-point; while the more infusible lot will reach a temperature also not far above its own higher melting-point. No doubt each, in running down after it has melted, will be to a certain extent superheated above its melting-point, *i. e.*, in its passage, rapid as that passage is, it will receive some heat; but this will not be enough to compensate for the difference in their melting-points.

An extreme case may help to make this clear. Suppose that in one of two furnaces, otherwise alike, we were to charge along with our fuel, masses of frozen mercury, and in the other masses of iron at the same low temperature. Let us neglect for the moment the volatility of mercury. When our mercury has descended a few feet at most it will melt, and will immediately run to the bottom of the furnace with great velocity. Our iron on the other hand will descend slowly through the furnace and will not melt until it had reached a level at which the temperature is 1600° C., its own high melting-point. Both the molten mercury and the molten iron in descending will certainly undergo a slight superheating, and the molten mercury, having a greater distance to

travel than the molten iron, would undergo a greater superheating. Nevertheless, this would not compensate for the fact that the mercury started to run down through the furnace as soon as it had been heated to a temperature of -40° C., while the iron remained solid until it reached a temperature of 1600° C., when it in turn melted and ran. I dwell upon this principle because it underlies all reducing smeltings in shaft furnaces.

A second and less important reason why the more infusible slag leads to higher hearth temperature is that it gums over the walls of the lower parts of the furnace to a greater thickness, and so in effect thickens those walls and lessens the conduction of heat outward through them.

For the above two reasons, increasing the infusibility of the slag leads to higher temperature and thus to more thorough deoxidation.

Still a third reason why infusibility of slag favors deoxidation is that, in the way already sketched, it prolongs the exposure of the metallic oxides and of the silica, phosphoric acid, *etc.*, to the deoxidizing conditions in the furnace; and this added exposure is especially effective because of the very high temperature which accompanies it, and also for another reason, which is as follows. When silica, lime, iron oxide, *etc.*, are free, *i. e.*, when they are not in chemical combination with each other or with other substances, they are more readily deoxidized than when they are in such state of combination, because the bond which holds them together in any combination has to be broken before deoxidation can occur. In other words the bond between two combined substances is an impediment to their deoxidation. Now if the silica, iron oxide, lime, *etc.*, exist in the ore initially uncombined with each other, they may remain so up to the time when fusion sets in, or at least very nearly till then; but after fusion has set in these different substances are necessarily combined, and silica with the lime and any iron oxide which had escaped deoxidation. Hence deoxidation is in general easier, other conditions being equal, before than after fusion.

Manifestly the leaner the ore, *i. e.*, the greater the proportion of gangue, the more important will this consideration be; and in smelting copper ores it may be of the very greatest importance, because copper ores are very lean, *i. e.*, contain a very large quantity of gangue.

307. REGULATION OF MELTING-POINT OF BLAST-FURNACE SLAG BY MEANS OF ITS COMPOSITION. — Let us next ask what the ways are in which the manufacturer may vary the composition of his slag, in order thereby to vary its melting-point, and thereby the hearth temperature, and finally the sulphur and silicon-content of the pig iron.

Blast-furnace slags are essentially silicates of lime, magnesia and alumina, and almost necessarily so. In many cases it is well to consider very carefully the most desirable alumina-content; but such a search would take us too far for the purposes of the present outline. That which the manager actually varies from week to week for the purpose of controlling the working of his furnace is usually the lime-content, and this he does by varying the proportion of limestone to ore charged. For our purposes we may consider lime and magnesia as substantially equivalent, in order to simplify our problem; so that the question before us is substantially, how do the variations in the lime-content of the slag affect the fusibility of that slag.

On referring to Fig. 115, it is to be seen that the great majority of blast-furnace slags are, so to speak, on the lime side of the greatest fusibility; that is to say they contain more lime and magnesia than the most fusible lime-magnesia-alumina silicate contains.

The reason why they habitually are on the lime side of the most fusible ratio is that by means of a slag rich in lime, sulphur is more readily removed from the iron. If we take two extreme cases, one a slag consisting of CaOSiO_2 and the other consisting of 2CaO , SiO_2 , it is evident that calcium would be more easily deoxidized from the latter than from the former by the reaction:

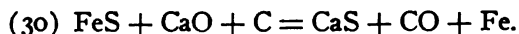

This is of course in harmony with the general principle that a given element or oxide, in this case the lime, is less tenaciously held in a chemical compound in which it is in excess, than in one in which it is in a sense deficient. From very high oxides in general, for instance from peroxide of hydrogen, H_2O_2 , oxygen is readily removed. Ferric oxide, Fe_2O_3 , and cupric oxide, CuO , are readily deoxidized to magnetic and cuprous oxides respectively, Fe_3O_4 and Cu_2O , by simple exposure to heat. So, too, carbonic acid, CO_2 , is readily decomposed into carbonic oxide, CO , and oxy-

gen, by heat alone. A slag rich in lime is irretentive of lime in the sense that its excess of lime is held but feebly by the silica, and because of the feebleness of this hold this lime is readily deoxidized by reaction (30).

The silica and lime of the slag are bound together chemically, and the strength of this bond opposes the removal of the silica or the lime by deoxidation. But if there is an excess of lime, this excess is bound less powerfully to the silica than if there is but little lime. Because the bond between the excess of lime and the silica is thus relatively feeble, the opposition which the bond offers to the deoxidation of the calcium is the feebler, and the calcium is consequently the more easily deoxidized the richer in lime the slag is.

Conversely, if the slag is deficient in lime, or in other words has an excess of silica, then for like reasons silicon is the more readily deoxidized.

This then is the reason why the blast-furnace charge is habitually so made up that the slag may be rich in lime, in order that it may thereby be irretentive of lime, and so that in turn this irretentiveness may favor the deoxidation of calcium by reaction (30), and thereby the removal of sulphur from the iron. Of course, if very little sulphur is present, or if for any cause desulphurization is not sought, then this reason for having our slags rich in lime no longer exists. Hence we often find that the slags of charcoal blast-furnaces are not rich in lime, for the simple reason that the charcoal lacks the sulphur which coke and anthracite always contain, so that there is no need of desulphurizing, unless the ore or limestone introduces sulphur into the charge.

Now since our slags are habitually on the lime side of the greatest fusibility, any addition of lime will carry them farther in composition from that of the greatest fusibility, and so make them more infusible; and conversely diminishing the lime-content will make them more fusible. The rubric in line *C* of column 1 of Table 19 is based on this principle.

Having thus seen that increasing the lime-content of the slag or in other words increasing the proportion of limestone charged, should tend to raise the hearth temperature, we record this fact by means of the plus sign in line *C* of column 2; and since this tendency to raise the hearth temperature should, for the same

reasons as before, tend to increase the silicon-content of the pig iron but to lower the sulphur-content, we accept the plus and minus signs in columns 3 and 4 respectively of line C.

308. DIRECT CHEMICAL EFFECT OF THE LIME-CONTENT OF THE SLAG. — Having now seen how an increase of the lime-content of the slag raises its melting-point, through this raises the hearth temperature, through this strengthens the reducing action, and through this raises the silicon-content and lowers the sulphur-content of the iron; in short, having seen what the thermal aspect of such an increase is, let us now consider what the direct chemical influence is.

For the reason which we have just considered, an increase in the lime-content by favoring the reaction (30) clearly promotes desulphurization. Therefore we may accept the minus sign (—), in line C, column 6 of Table 19.

But for the same reason, when we increase the lime-content of a lime silicate, the decrease which we thereby (by difference) cause in its silica-content makes it more retentive of silica. In other words, in a slag containing less silica and more lime, the silica is more tenaciously held by that excess of lime than in a lime silicate rich in silica; or an increase in the percentage of lime, while making a slag irretentive of lime, increases in proportion its retentiveness of silica, and proportionally opposes the deoxidation of silicon by the reaction:



In short, increasing the lime-content opposes the deoxidation of silicon, and so tends to lessen the silicon-content of the iron, and thereby to make the iron less gray. This justifies us in accepting the minus sign (—) placed in line C, column 5.

Considering now the thermal and the direct chemical influence jointly we see that, as regards sulphur, these two influences are alike, both of them favoring desulphurization; hence the minus mark (—) in line C column 8; but that as regards silicon the thermal effect of an increase in lime-content (column 3), is opposite to its chemical effect (column 5). Hence, the plus or minus sign (\pm) entered in line C, column 7.

The marks which we have now entered in columns 2 to 8 of line C lead directly to the marks which are now entered in columns 9 to 11 of that line.

309. THE EFFECT OF MOST VARIABLES ON THE SILICON-CONTENT IS THE OPPOSITE OF THAT ON THE SULPHUR-CONTENT. — Now looking back on Table 19 as a whole we notice that, with the exception of the direct chemical influence of the lime-content of the slag, the influence of each variable on the silicon-content is the opposite of its effect on the sulphur-content. In other words, those changes in the management of the furnace which tend to desulphurize and thus to make the iron grayer, simultaneously increase the silicon-content and thereby also tend to make the iron grayer.

From this fact arises the difficulty of making cast iron at once low in silicon and low in sulphur. Of the principles here tabulated only an increase in the lime-magnesia-content of the slag tends to decrease both the silicon and sulphur. In case we are called upon to make an iron low in both silicon and sulphur this then would be the principle on which we should chiefly rely.

310. RELATIVE PROMPTNESS OF DIFFERENT METHODS OF RAISING THE HEARTH TEMPERATURE. — We may recognize two kinds of considerations which may demand that the hearth temperature shall be raised. Thus, first, we may wish to change permanently or for a long period the condition of affairs, wishing to make an iron grayer than that which the furnace has normally been making, grayer either through containing more silicon or less sulphur or both, than the present product. Or, second, we may need to raise the temperature to meet a temporary and abnormal trouble, a temporary cooling due to the leaking of a tuyere or a bosh-plate, which is sending a stream of water into the hearth, and cooling it abnormally and indeed intolerably. To meet the latter state of affairs it is important that the remedy applied shall take effect promptly. Of the three means which we have been considering of raising the temperature of the hearth, *viz.*,

- (1) increase in blast temperature,
- (2) increase in fuel ratio (*i. e.*, lightening the burden), and
- (3) raising the melting-point of the slag,

the first one will give much the quickest relief. Our fuel, flux and ore are introduced only through the top of the furnace, and many hours must elapse between the time when we change the burden or the limestone ratio, and the time when the extra fuel or the extra lime will reach the hearth of the furnace. On the other hand, increasing the temperature of the blast immediately

throws an increased quantity of heat into the hearth. A difficulty in the way, however, often is that just at the time when we are in need of a hotter blast, the furnace gases on which we have to rely for heating that blast are from the same cause lean in carbonic oxide, *i. e.*, of low heating power. Hence the importance of so arranging matters that a deficit of gas can be met by firing our boilers with coal or other fuel, so that we may be free to turn into our hot blast stove a larger quantity of gas.

But though many hours must elapse between the time of increasing our fuel ratio and that in which this increase in fuel actually reaches the hearth so as to generate there an increased quantity of heat; nevertheless, this increase in fuel ratio gives relief much more quickly than might be expected, for the reason that the fuel is in large angular lumps which mechanically open up the charge in the upper part of the furnace, thus lessening the frictional resistance to the upward travel of the gas, and thus hastening the operation as a whole. In particular, since the blast can enter at the bottom of the furnace only so fast as the gases escape from its top, this opening action of our extra fuel has the same effect as an increase in the blast pressure, and permits us to blow in more air per second with the consequence that we burn more fuel per second, and hence generate more heat per second, while the abstraction of heat by conduction through the furnace walls remains substantially constant. In short, it increases the heat development per second without corresponding increase of the heat removal.

CHAPTER XIII. — METALLURGICAL GAS FURNACES

311. **GAS-FIRING AND DIRECT-FIRING.** — In a sense all reverberatory furnaces are gas furnaces, because they are heated by a flame, and a flame is only burning gas; so that in every case they are heated by burning gas.

312. **BY DIRECT-FIRING** is meant burning coal or other solid fuel in a fire-box close to the working chamber of the reverberatory furnace, and in a layer so thin that enough free atmospheric oxygen passes through some of the wider crevices between the lumps of fuel, both to burn the carbonic oxide generated by the incomplete

combustion of the fuel by the limited quantity of air which passes through other and narrower crevices, and also to burn the hydrocarbons, if any, distilled from the fuel. Thus both the combustible gas and the air for burning it escape simultaneously and side by side from the surface of the fuel; the flame begins at the very surface of the fuel.

313. BY GAS-FIRING is meant chiefly burning the fuel in a layer so thick that all of the oxygen of the air which passes through it combines with the fuel, and that nearly all of it forms carbonic oxide with the carbon of that fuel; so that from the surface of the fuel escapes a stream of combustible gas, chiefly the carbonic oxide thus formed and hydrocarbons from the distillation of the fuel, diluted with the atmospheric nitrogen. The stream of gas is in turn burnt by air specially admitted for this purpose. Thus in direct-firing, it is flame proper which escapes from the surface of the fuel, while in gas-firing it is not flame but combustible gas to be later converted into flame.

In short, in direct-firing the fuel bed is so thin that it delivers flame direct from its surface; in gas-firing it is so thick that it delivers there a stream simply of combustible gas. This is the essential distinction.

314. KINDS OF GAS USED IN METALLURGY.—Gas made in the way just described is called "producer gas," or sometimes "air gas," to distinguish it from natural gas, from distilled gas made by the destructive distillation of bituminous coal, and from "water gas," made by passing steam over incandescent fuel, by the reaction

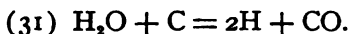

While in a few favored places like Pittsburgh natural gas can be had, the gas used in metallurgical processes is nearly always producer gas modified by the presence of some water gas; *i. e.*, some steam is mixed with the air used for making the producer gas itself. (See § 326, p. 429.) Under usual conditions this gas is probably far the cheapest per unit of calorific power. It is, however, so bulky, *i. e.*, so greatly diluted with atmospheric nitrogen, that the expense of installing pipes large enough to distribute it for domestic use would in general be prohibitory. In metallurgical establishments the distance through which the gas has to be carried is so short that its diluted condition is not a serious matter.

As nearly all of the gas used for heating iron and for melting steel is this modified producer gas, so when gas-firing for these purposes is spoken of, it is generally understood to be producer-gas firing; and in the following discussion it is this gas which is referred to. For heating the blast and raising steam for the iron blast-furnace, and also of late for burning in gas engines, the waste gases of that furnace are used; but not for heating or melting steel.

The description of direct-firing above given is that of the extreme type. In many cases, while much free oxygen passes through the fuel uncombined, and is thus in a position to burn the carbonic oxide and hydrocarbons which it then meets, yet there is not enough of it to burn the whole of these, and more or less additional air, often preheated, is admitted above the fuel to complete the combustion. This case is intermediate between the typical direct-firing and gas-firing. We need not here consider where the dividing line should be drawn.

315. PURPOSE OF GASIFICATION.—Gas furnaces, chiefly of the Siemens type (§ 276), are used for the open-hearth steel-making process (indeed, all open-hearth steel furnaces are of this type), and to a very great extent for reheating steel, and for melting steel by the crucible process. In other branches of metallurgy they are used relatively little. Let us ask why they are so much used in these steel processes, and why not in other metallurgical processes. The difference is not to be put down to the stupidity or ignorance of non-ferrous metallurgists, but, as in most such cases, is due to fundamental differences in conditions.

The gas furnaces which we are now considering are reverberatory furnaces, and our question really is as to the relative merits of gas-fired reverberatories like that shown in Figs. 98 and 99, and "direct-fired" ones, such as that shown in Fig. 116.

Every reverberatory furnace may for our present purpose be regarded as a system for heating a charge of metal or other substance by means of a flame passing by it, usually passing over it; a flame is burning gas; and the system may be divided into three parts, (1) the preparatory part in which the fuel is converted into gas, and the air is preheated, *etc.*; (2) the working chamber or laboratory in which the charge of metal, *etc.*, is heated, melted, *etc.*; and (3) the chimney through which the products of the combustion of the flame are carried away. Comparing gas and

direct-fired systems, while the dimensions of the chimney do not differ very strikingly, yet there is an enormous difference in the ratio of the volume of the preparatory part to the working chamber. This is readily seen on comparing the Siemens furnace shown in Figs. 98 to 101 with that of any direct-fired furnace, such as a common puddling furnace (Fig. 116). In the Siemens system the flame-preparing part as here shown is about thrice as large as the working chamber; including the gas-producing plant it is perhaps four times as large as the working chamber; while in the direct-fired furnace it is often not more than half as large as the working chamber. Thus, in order to use the Siemens system, the preparatory part of the apparatus has to be increased in size four-fold or even more, and the cost of intalling the system, as well as the cost of repairs, is thus very greatly increased.

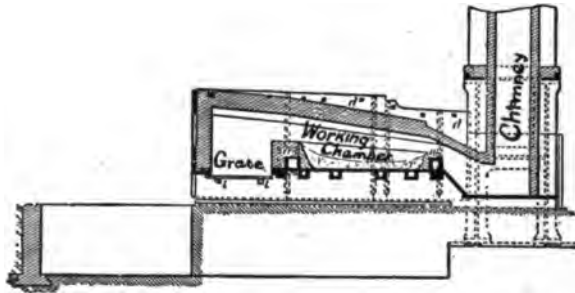

Fig. 116. Direct-fired Reverberatory (Puddling Furnace).

There are, indeed, other forms of gas furnace, of the recuperative system (Morgan furnace, Fig. 113, p. 377), in which the fuel-preparing part of the apparatus is much smaller and less costly than in the Siemens system. In the recuperative furnaces the heat is filtered out of the escaping products of combustion by passing them around a system of clay pipes or its equivalent, while through those pipes the air which is to burn the gas is passed, or *vice versa*.

To these recuperative furnaces the objection of excessive first cost applies less strongly than to the Siemens system; nevertheless it applies, and with force. It will suffice for our present discussion if we confine our attention to a comparison of the direct-firing system with the Siemens system; for while the recuperative system is less expensive to install than the Siemens, it is less economical of fuel under most conditions, and probably also more expensive to maintain.

That the great expense of installing and maintaining the Siemens furnace is endured implies that some corresponding great advantages have been proved. What are these?

316. THE ADVANTAGES OF GAS-FIRING as such are:

(1) *That the Temperature and Character of Flame* are under better control.

(2) *Fuel Economy*: that it permits recovery of the heat which, in direct-fired furnaces, is carried away by the products of combustion and lost. This recovery of course permits a corresponding economy of fuel.

(3) *Higher Attainable Temperature*. — This recovery of the heat of the products of combustion permits generating a much higher temperature than is possible with direct-firing, a temperature which is limited only by the danger of melting down the materials of which the furnace is made. Indeed, one of the chief cares of the open-hearth steel melter in using the Siemens' furnace is to avoid melting the furnace itself, although this is built of the most infusible fire-bricks to be had.

Let us consider these advantages in detail.

317. TEMPERATURE AND CHARACTER OF FLAME UNDER BETTER CONTROL.* — The combustion of bituminous coal may for the present purpose be regarded as composed of four parts.

(A) carbon burns at and near the grate-bars to carbonic acid,

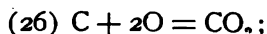

(B) the resulting carbonic acid is reduced to carbonic oxide by the carbon of the overlying fuel,



* *Oxidizing, neutral and reducing flames*. It is common to say that the flame of gas furnaces may at will be made either oxidizing, neutral or reducing: but "reducing" is a relative term. A flame which would be reducing toward copper might be highly oxidizing toward iron. In order that a flame shall generate the high temperature required in heating iron for rolling, and in melting steel, the combustion of the flame must be nearly complete, and this implies that most of the hydrogen, hydrocarbons and carbonic oxide shall be converted into steam and carbonic acid; and this in turn implies that the flame must necessarily be oxidizing towards iron, because both steam and carbonic acid oxidize hot iron rapidly. It is therefore misleading to talk about a heating or melting flame in iron metallurgy as "reducing." All we can say is that some flames are strongly oxidizing and some are only mildly oxidizing.

(C) the hydrocarbons of the fuel are distilled;

(D) the carbonic oxide and the hydrocarbons from *B* and *C* burn to carbonic acid and steam; with these products is mixed the nitrogen which accompanied the atmospheric nitrogen of phases *A* and *D*.

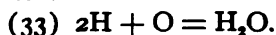
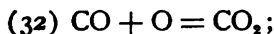

If phase *A* alone occurred there would be no flame, because flame is burning gas. A burning solid gives no flame, unless distillation or combustion gives rise to a gas. The burning of that gas causes flame, and this flame may look as if it was the combustion of the solid; but really it is only the combustion of gas evolved from the solid.

In the present case, the gas which in burning gives flame is the carbonic oxide resulting from phases *A* and *B* jointly, and the hydrocarbons resulting from *C*; the burning of the flame itself, *i. e.*, the combustion of that gas, is phase *D*.

The carbonic oxide and hydrocarbons from *B* and *C* are deoxidizing; the carbonic acid and steam from *A* and *D* are oxidizing towards iron. Any free oxygen which accompanies them intensifies the oxidizing character of the flame; if the air admitted for *D* is insufficient to burn the whole of the carbonic oxide and the hydrocarbons, this deficiency weakens the oxidizing character of the flame. *A* and *D* thus strengthen while *B* and *C* weaken oxidation. Further, *A* and *D* are exothermic; *B* and *C* endothermic. Hence, if the character, *i. e.*, the strength of the oxidizing power of the flame, and also the temperature, are to be constant or indeed to be closely under control, the degree to which phases *B* and *C* on one hand, and *A* and *D* on the other take place must be constant or under control.

That this constancy and control are much greater in gas- than in direct-firing is readily seen.

For suppose the coal on a direct-firing grate has been freshly stoked so carefully and evenly that the quantity of oxygen which, passing through the wider interstices between the lumps of fuel reaches the upper surface free and uncombined, is just enough to burn completely the combustible gases which it there meets, (1) the carbonic oxide from phases *A* and *B* occurring in the narrower crevices in which the oxygen is more fully exposed to

the fuel, and (2) the hydrocarbons distilled from the freshly charged fuel.

Here we have as oxidizing factors (1) the supply of this free unscathed oxygen, and (2) the degree to which the carbonic acid from *A* escapes *B*; and as deoxidizing factors the supply of carbonic oxide from *B* and of hydrocarbons from *C*. The character of the flame depends on the balance between these two sets of factors, a balance which in direct-firing clearly must shift rapidly and widely. For as the air passes up through these passages it widens them all by burning away the fuel which bounds them, thus lessening the intimacy of contact of air and fuel, and thus increasing the proportion of free oxygen and of carbonic acid from *A* and lessening the supply of carbonic oxide from *B*. Moreover the air passes the faster through the initially larger passages and therefore widens these the faster, and thus further augments the proportion of the whole air which passes through them, and thus the proportion of free oxygen and carbonic acid; the initially smaller passages at the same time not only convert the carbonic acid to carbonic oxide less thoroughly because constantly widening, but they have a decreasing proportion of the air to operate upon, so that in both these ways the supply of carbonic oxide decreases.

At the same time the supply of hydrocarbons from *C* is probably diminishing rapidly, because the high temperature of the thin fire upon which the fresh coal is charged leads to a distillation of hydrocarbons so rapid as to restrict itself quickly through exhaustion of the supply.

Thus the balance shifts rapidly towards stronger oxidation, through increase in the proportion of free oxygen and carbonic acid, and simultaneous decrease in the supply of carbonic oxide and hydrocarbons.

Further the heat development must shift in like manner. It depends on the ratio between the supply of free oxygen and the supply of carbonic oxide and hydrocarbons. As this ratio changes so will the temperature generated. With a certain ratio of free oxygen to carbonic oxide and hydrocarbons the highest temperature will be generated; shift this in either direction, either by cutting off carbonic oxide and hydrocarbons so that free oxygen is in excess above this ratio, or vice versa, and the temperature sinks.

In gas-firing the conditions are under better control, as will now be explained. It is the necessary thinness of the bed of coal in direct-firing that causes the rapid shifting in the degree to which the carbonic acid from *A* is reduced to carbonic oxide by *B*, and thus in the carbonic oxide supply, as well as in the degree to which free oxygen passes unscathed through the fire, and thus in the free oxygen supply; it is this same thinness that makes the upper surface of the fire so hot that the hydrocarbons of the freshly charged fuel distill with a supply-exhausting rapidity. To prevent this shifting and to retard this distillation we have but to make the fuel-bed deep, as we do in gas-firing, so that no free oxygen can get through it, and that nearly all the carbonic acid from *A* is reduced to carbonic oxide by *B*; this gives us a nearly constant supply of both carbonic oxide and hydrocarbons. The gas is thus made in a special apparatus, the gas-producer, under constant and controllable conditions. The gas is next converted into flame by phase *D* in the working chamber itself, by admitting air there. By thus separating the gas-making and the gas-burning operations each is brought under control. We regulate the strength of the oxidizing conditions and the temperature by varying, by means of valves, the supply of gas and of air.

The Morgan furnace, Fig. 113, p. 377, would represent gas-firing with the sole aim of thus getting control over the temperature and character of the flame, if we were to strike out the very simple arrangements there shown for preheating the air used in phase *D* of the combustion for burning the gas from phases *B* and *C*.

318. FUEL ECONOMY.— In most reverberatory furnaces, and particularly in the open-hearth steel melting furnace, in which it is necessary that the temperature of the working chamber throughout its length should be above the melting-point of steel, say above 1600° C., it is necessary that the flame itself should throughout the length of the working chamber be at a very high temperature, and hence that the flame must escape from the working chamber at this very high temperature and therefore must carry out with it most of its sensible heat. In a direct-fired furnace most of the heat developed by the combustion of the fuel will thus be carried out of the furnace in the flame, during the latter part of the heating operation when the ingots which are heating have nearly reached the temperature of the flame, and

therefore have little further power of absorbing heat from it. Gas-firing affords a ready way of recovering this heat by pre-heating the air by either the regenerative (Siemens) or the recuperative system.

As an alternative a large part of this heat may indeed be recovered by passing the flame under steam boilers. The inconvenience of this method is very great, especially because the supply of steam from this source is likely to vary greatly. On this account it has in some cases been found that the cost of raising steam by the waste heat from heating furnaces is greater than by boilers independently fired. In short, it may cost more to recover heat in this way than it is worth, if fuel is very cheap.

As the purpose of these regenerative and recuperative arrangements is to recover the heat carried away from the working chamber by the products of combustion, so they become less important or even needless if this heat can be utilized directly in the heating chamber itself. In certain cases this can be done, as for instance in Morgan's continuous heating furnace, Fig. 113. In this by charging cold ingots one by one at short intervals at one end of the furnace, and pushing them along towards the hot end, and by passing the flame over them in the opposite direction, a very large proportion of the heat of the products of combustion is recovered directly in the working chamber itself, and they escape at so low a temperature that no great outlay for further recovery of their heat would be profitable. This illustrates the principle, perfectly obvious when enunciated, that large outlay for recovery of the heat of the products of combustion, *i. e.*, for regeneration or recuperation, can be profitable only when there is much heat in those products, *i. e.*, when they would otherwise escape from the working chamber at a very high temperature, or when they are in very great quantity. It is because in Mr. Morgan's furnace the charge itself recovers so much of the heat of the products of combustion, that he goes to such slight expense in so building his furnace that it shall itself recover a further fraction of that heat, by recuperation. In other words, because his charge itself cools the products of combustion so far, *i. e.*, leaves so little heat in them, only a relatively small and inexpensive recuperative installation is called for to recover that little heat.

Here we have the essential reason why gas-firing and regeneration have been applied chiefly to iron and steel metallurgy;

and that relatively little profit has been found in applying them to other branches of metallurgy. In these other branches it is usually true either that operations are on a relatively small scale, or that the temperature needed is relatively low; and in either case the total value of the heat in the escaping products of combustion is correspondingly small. Thus in copper refining the temperature is so low and hence the escaping products of combustion contain so little heat that no great outlay for recovering it would usually be justified.

Of course, the value of heat is the cost of reproducing it. If fuel is locally very expensive and the value of a unit of heat therefore correspondingly great, then regenerative arrangements for recovering the waste heat of copper refining furnaces might be profitable; they might be profitable in Sweden with its dear coal, though unprofitable in Pittsburgh with its cheap coal.

319. COMPARISON OF REGENERATIVE AND RECUPERATIVE FURNACES. — Let us recapitulate the essentials of the Siemens and the recuperative systems.

In the regenerative or Siemens system the heat is first filtered out of the escaping products of combustion by passing them through large chambers loosely filled with a checkerwork of brickwork; and it is then transferred to the gas, and to the air used to burn that gas, by passing these, before they come into contact with each other and burn, separately back through these same filtering chambers or *regenerators*. (§ 276.)

In the *recuperative system* the heat is filtered out of the escaping products of combustion by passing them around a system of clay pipes, while through the interior of those pipes the air used for burning the gas is passed, or *vice versa*, (Fig. 113, p. 377).

Comparing these two systems, the Siemens has the advantage of recovering the waste heat of the products of combustion more effectively, chiefly because the heat-filtering surface is kept more efficient, or in other words because it uses the right side of its brickwork to catch the heat, while the recuperative system uses the wrong side of a clay tube.

A second reason why the Siemens system recovers the waste heat more thoroughly is that in it both the air and the gas can be used for that recovery; whereas in the recuperative system the air alone can be thus used. In other words, regeneration can be of both air and gas, while recuperation can be of air only. This

advantage, this gas regeneration, of the Siemens system was formerly thought important; but a closer examination, and especially the experience of the last few years, go to show that it is of relatively little weight, and that little is gained by adding gas regeneration to air regeneration. To this we will return in § 321.

In the greater ease and cheapness of repairs the Siemens system probably has a further great advantage, at least when very high temperatures are reached. The plain bricks with which it catches the heat are not only cheap but durable, compared with the clay tubes or their equivalent used in the recuperative system.

320. THE SIEMENS SYSTEM CATCHES THE HEAT ON THE RIGHT SIDE. — In the Siemens system the surface of brickwork upon which in one phase the heat is deposited, is the same surface which is exposed to the incoming gas or air during the alternate phase; it is one and the same surface which stores heat in one phase, and restores it in the next: hence this surface is an efficient instrument for thus storing and restoring heat. But in the recuperative system it is to one surface of the pipes that the passing products of combustion are exposed, and to the other surface that the air is exposed; it is one surface of the pipes that stores the heat and the other that restores it; and the storing and restoring surfaces are thus separated by a wall of clay, which, because it is so bad a conductor of heat, very greatly impedes the passage of the heat from the storing surface to the restoring surface, and so lessens the efficiency of the apparatus as an instrument for transferring heat from the escaping products of combustion to the incoming air. That these walls should be of clay seems unavoidable. Metallic pipes would be quickly destroyed, and no other well conducting substance seems available, at least for high temperatures.

Looking at it in another way, only a cold object can be a good heat catcher; the hotter it is the less heat can it take up from the passing products of combustion. In the Siemens system the heat-catching surface of the regenerator bricks begins each phase efficiently cooled by the direct passage over it during the preceding phase of the incoming gas or air; while in the recuperative system this needed cooling of the heat-catching surface is opposed by the bad conduction of the fire-clay walls of the pipes. In short, the Siemens system catches the heat with the right side, the recuperative system with the wrong side, of a clay mass.

321. THE VALUE OF GAS REGENERATION. — I will first explain the reasoning which formerly led to the belief that gas regeneration was very important, and then point out why its real value is probably much less than was formerly supposed.

That a heat-catching system should work implies two things: first that it has an opportunity to catch heat; second that this heat is thoroughly removed from it. No such system can store an indefinite quantity of heat; should the checkerwork of the Siemens system be as hot as the products of combustion passed through it, it could take no heat from them. Only in virtue of its being cooler than they, can it take heat from them. That it shall continue to take heat from them requires that the heat which it takes shall be in turn removed from it; the heat which it receives it must again give out before it can receive more.

Again, the products of combustion cannot heat any system to a temperature higher than their own.

Now the flame and hence the products of its combustion are made up of from two sources, the producer gas itself, and the air with which that gas is burned. In the recuperative system this air alone is used to recover the heat deposited in the recuperative pipes; while in the Siemens system both gas and air are used habitually for this purpose. Since the weight of the gas and air is equal to that of the products of combustion, and since (if we assume for simplicity that the specific heat of all is the same), their capacity for heat (weight \times specific heat) is the same as that of the products of combustion, they are theoretically capable of absorbing all the heat of those products. That is to say, it is theoretically conceivable that were there no losses of heat by conduction through the walls of the regenerators, *etc.*, these regenerators might cool the products of combustion down to the temperature of the incoming air and gas; and might in the following phase, heat up that air and gas to the temperature at which the products of combustion leave the working chamber; in which case the incoming gas and air would, in this sense, recover the whole heat of the products of combustion.

Of course, this result could never be fully attained; it is, however, the limit towards which the system works. But in the recuperative system, since the weight of the air is only about half that of the products of combustion, and since the air alone is used for absorbing their heat, the system is theoretically capable

of absorbing only about half their heat; for manifestly they cannot heat that air hotter than they themselves are, and consequently can give to it only about half their heat.

To illustrate this, let us take a case in which no steam is used in the gas producer, *i. e.*, in which true producer gas unmixed with water gas is made, and let us assume that 120 parts by weight of air are used to burn 100 parts of producer gas:

Let w' = the weight of air used in the producer to gasify the coal, *i. e.*, the gasifying air, per ton of coal,

w'' = that used in the working chamber to burn that gas, or the gas-burning air,

w''' = the weight of the gas itself,

W = the weight of the products of combustion,

T = the temperature at which the products of combustion escape from the working chamber,

Sh = the specific heat of gas, air, and products of combustion, assumed for simplicity to be of the same specific heat,

H = the quantity of heat in the products of combustion as they escape from the working chamber, per ton of coal,

hS = the quantity of heat theoretically recoverable in the Siemens system, and

hr = that recoverable in the recuperative system.

Then from our assumptions

$$(1) \quad w''' = w' + 1,$$

$$(2) \quad W = w'' + w''',$$

$$(3) \quad H = W \times T \times Sh,$$

$$(4) \quad w' = w''' \times 1.2.$$

To simplify the problem let us assume that the gas and air enter each heat-system at the temperature at which the products of combustion escape.

In the Siemens system both the gas itself and the gas-burning air are available for recovering heat; hence

$$(5) \quad hS = (w'' + w''') \times T \times Sh.$$

In the recuperative system, only the gas-burning air is thus available; hence,

$$(6) \quad hr = w'' \times T \times Sh.$$

From (4)

$$(7) \quad hS = hr (1.2 + 1) \div 1.2 = hr 1.83,$$

or in short, gas regeneration promised to increase the value of the heat-catching system by 83 per cent; it promised to give the

regenerative system 83 per cent greater heat-catching power than the recuperative system.

This defect of the recuperative system, that the incoming gas cannot be used to recover the heat of the products of combustion, or in other words that gas-recuperation is impracticable, appears to be inevitable; for we see no way in which the gas can be passed inside the pipes of such a system. The reason for this is that the hydrocarbons of the producer gas break up and deposit carbon when heated; and if passed through these hot pipes they would thus quickly choke them with deposited carbon. In the Siemens system this difficulty does not arise, because any carbon deposited in one phase on the surface of the regenerator bricks is burnt away by the free oxygen always present in the products of combustion passing over that same surface in the next following phase.

The advantage of gas regeneration, however, on further examination turns out to be much less than we have calculated. In the first place, the losses through radiation from the outside of the regenerative system, and the heat needed to give the chimney draught, represent a large fraction of the heat of the products of combustion, and leave in them just so much less heat capable of being caught by any system whatsoever; this reduces correspondingly the margin of heat to be caught over and above that which air regeneration (or for that matter air recuperation), can catch, and thus diminishes the possible gain to be had through gas regeneration. In the second place, as it is only in virtue of entering the regenerators cold or cool that the gas is capable of absorbing heat, in gas regeneration the sensible heat developed in the gas producer is necessarily wasted, or at least it detracts correspondingly from the heat-catching power of gas regeneration.

But, in spite of this, the calculable advantage of gas regeneration seemed so great that no reasonable allowance for these considerations seemed likely to reduce it to an unimportant quantity. Further Siemens reasoned that, since gas regeneration was thus so important, and since any sensible heat brought by the gas from the producer into the regenerative system simply lessened the efficiency of that system proportionally, there was no advantage in trying to save that sensible heat. He therefore set his producers at a convenient and usually great distance from the furnace. The sensible heat was in part utilized by making water gas in the producer as explained in § 326, p. 429, and in part

wasted by radiation from the walls of the producer and of the often very long gas conduits.

If, now, the gas actually issued from the producer at a temperature as high as that to which it is practicable to preheat it in the gas regenerator, and if we first wasted the sensible heat of the gas producer for the purpose of so cooling that gas that it would be capable of absorbing heat in the regenerator from the products of combustion, and then used for that purpose that gas so cooled, we should gain nothing. To waste a calory in order to be able to save another calory is futile. Now, while we may utilize much of the heat generated in the gas producer by making water gas by means of steam introduced along with the blast, yet we are limited in this direction by the fact that the temperature in the producer must be kept up to the point of ignition, lest combustion there cease, and our blast and steam pass through the bed of coal without generating gas. Therefore the gas must necessarily emerge from the top of the bed of coal at a rather high temperature.

If we call the temperature to which it is practicable to preheat the gas in the regenerator, T^h , and the lowest temperature at which it is practicable to have the gas escape from the top of the fuel in the producer, T^p ; then all the heat that this gas can really save out of the products of combustion is that represented by the expression $w'' \times Sh \times (T^h - T^p)$.

Just what the temperature difference $T^h - T^p$ really is remains to be proved. Apparently it is not very great. Hence it appears that the real economy of gas regeneration is not very great.

There is a second important consideration tending to lessen the value of gas regeneration. Producer gas from bituminous coal may contain much hydrocarbon which, when highly heated, splits up with the separation of lampblack. If the producer gas is taken straight from the producer with its initial sensible heat into the working chamber of the furnace, *i. e.*, if we do not use gas regeneration, the carbon thus separated immediately burns in that chamber and is thus utilized. If, however, we use gas regeneration, then when the gas enters the hot checkerwork of the regenerator the carbon, which as before separates, deposits on the checkerwork, where it remains inert until the next phase of the furnace, when the products of combustion pass out through this same

checkerwork. On meeting this deposited carbon they burn it, and sweep the heat which its combustion generates out to the chimney where it is lost.

It seems to be owing to these two considerations that, in actual large-scale tests lately made, it has proved that gas regeneration saved nothing. That is to say, first the Siemens steel-melting furnaces were worked with gas regeneration, and then in a direct comparative test and with all other conditions constant, the gas was carried direct from the producer to the working chamber. Under these latter conditions no more coal was used per ton of steel ingots made than when gas regeneration was used.

How far this may prove true under other conditions remains to be seen. It may be that in this particular practice the producer had been run needlessly hot, so that the margin $T^h - T^p$ was needlessly small, and that economy might have resulted from introducing more steam into the producer so as to lower T^p and increase the margin.

322. THE PROGRESSIVE RISE IN TEMPERATURE IN REGENERATIVE FURNACES.—In the Siemens system, the combustion in the working chamber is of gas and air preheated to say 1100° . In direct-firing, the combustion close to that working chamber is of coal with initially cold air. Manifestly, starting thus from a higher initial temperature, combustion should generate a much higher temperature in regenerative than in direct-firing. Moreover, each time the direction of the gaseous currents is reversed, the temperature should rise. Thus if we assume that the heat generated by the combustion of a given mixture of gas and air initially at 0° C. evolves enough heat to raise the products of that combustion to 1500° ; that the escaping products in passing through the regenerators heat those regenerators themselves to 1300° ; and that on reversing the current those regenerators in turn heat the now incoming gas and air to 1100° ; and that all other conditions remain constant, so that this new combustion, like the first, generates enough heat to raise its products through 1500° ; then it would generate a temperature of $1500^\circ + 1100^\circ = 2600^\circ$. Supposing this process to continue, there should be like elevation of temperature at each reversal.

Not only would any such sequence destroy any furnace quickly, but for obvious reasons the temperature, while it may

quickly rise especially in furnaces provided with large regenerators to a point at which it would destroy the brickwork, yet rises at a rate much less than that just sketched. As the temperature rises, the loss of heat by conduction through the walls of the furnace increases rapidly; in fact, the outflow of heat is so rapid as to suggest the simile of steam or other gas imprisoned at very high pressure in a furnace the very walls of which are porous, so that the steam escapes rapidly, not only through every crevice but through the walls themselves. Indeed this conception of the rapid outrush of heat from our high temperature furnaces and through their walls is an instructive and useful one.*

What actually happens is that the temperature of the regenerators, and through this the temperature of the incoming gas and air and of the working chamber, continue to rise until the rapidly increasing loss of heat through the walls and up the chimney, plus the heat absorbed by the charge of metal under treatment, just balances the heat evolved by the combustion.

It remains quite true, however, that if we wish to raise the temperature of the working chamber suddenly, we can do this by reversing the direction of the gaseous currents at very short intervals, which in some works are at times reduced to 10 minutes, or even less.

323. THE SIEMENS GAS PRODUCER. — As shown in Figs. 98 and 99, p. 352, this consists of an approximately rectangular fire-brick chamber, with a grate, on the rear end of which the coal is dropped from a hopper.

The grate consists of two parts; first, the nearly horizontal bars under the fuel, and, next, the lower part of the inclined wall at the left, which is here made up of iron plates so arranged as to form a kind of grate.

As the object in making a gas producer was to provide a bed of fuel deeper than that of the old direct-firing grates, it is natural that Siemens in this early producer used a grate much like that of a direct-fire, simply providing a deep chamber above

* Again, as the temperature rises the combustion becomes less complete, because dissociation goes the farther the higher the temperature; or rather because the principle which under other conditions would cause dissociation, here correspondingly restricts combustion. But as the products of this combustion thus made incomplete descend through the regenerators and thus cool down, the combustion thus arrested may continue.

it for holding the deeper bed of fuel, together with suitable hoppers, poke-holes, *etc.*

But a serious difficulty arose in trying to remove the ashes from beneath this deep bed of fuel, without letting the fuel itself fall through the grate along with the ashes. This formation and removal of ash is a more serious thing than might be supposed by those unfamiliar with such matters. If a producer gasifies daily three tons of coal containing 10 per cent of ash, with which is mixed, say, 10 per cent more of unburned coal, there are some 750 pounds of hot ash, clinker and unburnt coal to be cared for daily. To remove this from beneath a mass of fuel, which itself is in small lumps, was a difficult matter.

The method of removing the ashes was as follows: First, they were allowed to accumulate in a thick bed. Then a series of flat bars, called "false bars," was driven across the producer through this bed of accumulated ash, so that their further ends rested on the back (or right hand) wall of the producer. They were thus placed at such a height above the true grate bars that most of the accumulation of ashes was beneath them, while above them was the remainder of these ashes and the thick layer of still unburnt fuel. Then the true grate bars were pulled out, so that all the ashes below the false bars, thus deprived of support, fell down into the ashpit. Then the grate bars were replaced and the false bars withdrawn, letting the fuel down upon the grate bars, whereby the producer was restored to working condition.

This method was laborious, especially because the workmen while cleaning the fire were exposed to great heat; and wasteful of fuel, because with the ash thus removed a great deal of unburnt coal was mixed up. If, in order to hasten the work of the producer, the air was forced in under pressure, the disadvantages of the system were all the greater, for two reasons. First, in this case the fire was cleaned only at rather long intervals, because in order to clean it the blast had to be stopped, and the producer thus thrown temporarily out of use, or its gas output, at the best, very greatly lessened; and during these long intervals the accumulation of clinker became all the more serious. Second, the higher local temperature, to which the more rapid combustion led, heated much of the ash so hot that it melted and ran together into large clinkers, very difficult to remove from beneath the overlying fuel.

The formation of clinkers under these conditions was materially lessened by using a steam jet as a means of forcing the air through the producer, for two reasons. First, the steam itself was decomposed by the strongly endothermic reaction

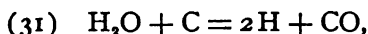

and the local temperature was so much lowered, by the absorption of heat by this reaction, as to lessen the melting of the ash into clinker. Second, an examination of the ash indicated that the moisture which condensed from this steam in the lower layers of ash, below the level at which combustion was active, itself decomposed some of the clinkers which had formed in the hotter level of active combustion above, when they in turn reached this lower and cooler level.

Further, by thus lessening the formation of clinker and breaking up that which forms, the steam passed through the producer probably lessens materially the quantity of coal which, entangled in that clinker, escapes unburnt, and is thus wasted. The use of steam in the producer has another advantage which can be understood more easily after studying § 326, p. 429.

But, even with the use of steam, the Siemens producer is so troublesome to clean, and the inconvenience of having its gas output so greatly diminished during the long cleaning period is so great, that it has been displaced to a great extent by more modern producers. Among these the W. J. Taylor and the Duff have come into such wide and successful use as to call for description. In each of these the ashes are withdrawn from under the fuel without interrupting the working of the producer. And, though in the Taylor producer their eventual removal from the apparatus may interrupt the gas output, this interruption comes at such long intervals, and is so brief, as to be unimportant.

324. **THE TAYLOR GAS PRODUCER.*** — The distinctive feature of this is that the column of fuel and ashes rests on a circular plate, which in revolving discharges the ashes over its edge into a sealed ashpit, and thus withdraws them from beneath the overlying fuel without disturbing it or interrupting the work of the producer.

* U. S. Patent, 399,798, William J. Taylor, R. D. Wood & Co., 400 Chestnut Street, Philadelphia.

The producer, Fig. 117, is a cylindrical shaft, with this revolving circular plate *AA* at its lower end, supporting the deep bed of ashes *BB*, and through these the deep bed of fuel overlying those ashes.

The ashes are removed occasionally by turning, or "grinding," the revolving bottom, *i. e.*, rotating it about the vertical axis of the producer by means of the crank *K*. This grinding both so disturbs them that they slide down the talus *CA*, falling thence into the closed ashpit *D* beneath; and, more particularly, it makes

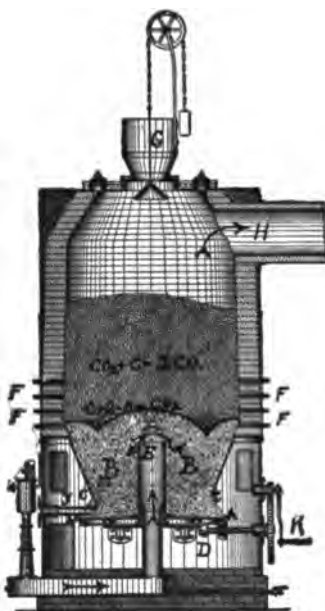

Fig. 117. The Taylor Gas Producer with Revolving Bottom.

the fixed bars *J*, set at four points in the periphery, plough the ashes outwards, and over the edge of *A*. As the ashes which at a given moment have formed this talus are thus discharged, those above them sink down to take their place; and while the ashes vertically above *C* doubtless descend somewhat faster than those to right and left, so that the imaginary surface which separates ashes from fuel probably follows the triple curved line which I have sketched, rather than the horizontal line which the makers of the producer show, yet no harm has been traced to this.

The air for gasifying the fuel is forced by a steam jet through the central pipe *E*, and thence discharged laterally. The fuel is fed through the hopper *G*, and the gas is drawn off through the pipe *H*. At intervals of, say, 6 to 24 hours the ash is "ground" down so as to keep its upper surface at a proper height, as seen through the peepholes *FF*. Should the ash descend too fast on, say, the left-hand side, the bars *J* on that side are withdrawn so as to retard the discharge there.

The lower edge of the cup *C* is high enough above the revolving plate *A* to give room for clinkers of usual size to pass; larger ones can be broken up by means of bars inserted through the holes shown in the iron cup above *C*. *C* is so placed horizontally with regard to *A* that the talus-slope *CA* is flatter than the angle of repose of quiescent ashes, but steeper than the angle of repose of ashes in motion; hence the discharge of ashes occurs only during grinding,—in short, it is under control.

The bed of ashes is made very deep, so as to give ample opportunity for any coal which passes below the region of active combustion to burn; and also so that the ashes shall cool thoroughly in their slow descent from the region of combustion to their discharge, and thus that the moving parts of the mechanism shall remain cool, and that the ashes, when removed at intervals of perhaps 24 hours from the ashpit, shall also be cool, and therefore cheaply handled. To avoid the expense of a blast pressure strong enough to force the blast through this deep bed of ashes, the blast pipe is carried up nearly to where the region of combustion is expected to be.

In a plain cylindrical producer, with a plain grate extending clear across it, the natural tendency would be that the fuel would descend fastest in the axis, and that the blast would travel fastest up the walls; in the Taylor producer both these tendencies are opposed, the former by placing the ash discharge near the periphery of the producer, and the latter by introducing the blast in the axis. These dispositions probably carry matters somewhat towards the opposite extreme, so that the fuel descends fastest along the walls, or rather just above the edge *C* of the iron cup, and that combustion is fastest in the axis; but the makers believe that any irregularity thus induced is much less than that of the plain cylindrical producer which it replaces. And, indeed, the great

depth of the beds, both of ash and of fuel, appears to remedy well any residual irregularity in this respect.

325. THE DUFF GAS PRODUCER.* — The distinctive feature of this producer (Fig. 118) is the water seal at its base, through which the ashes are raked without interrupting the working of the producer itself.

The fuel is charged through the hopper *G*; the blast is introduced beneath the comb-roof-shaped grate; and the gas is drawn off through *H*. The pan below is filled with water. As in the Taylor producer, the ashes form a very deep bed, here resting on the bottom of the pan and extending above the comb of the grate; while above them rests a deep bed of coal. The condition of the fire is learned by looking through the poke-holes *FF*; and is regulated (1) by charging, and (2) distributing fresh coal; (3) by poking from above; and (4) by raking out the lower end of the talus of ashes through the overlying water in the pan. As fast as these are thus raked out, the ashes and coal above descend.

The sensible heat of the ashes is utilized in evaporating water, which, in passing up through the producer, is in turn converted into water gas by the incandescent carbon.

The holes in the grate are in reality narrow slits. So narrow are they that most of the ash slides over them to right and left, instead of falling through them; though that which does fall through is, like the rest, eventually raked out through the water seal. The grate itself runs nearly completely across the producer.

Like the Taylor producer, this one has (1) the deep bed of ashes, favoring the thorough combustion of the fuel; (2) the blast admitted near the upper surface of the ash layer, so as to reduce the frictional resistance to its passage; (3) the combustion probably most rapid in the region where the descent of the fuel is probably the slowest. For combustion is doubtless fastest in the transverse band overlying the grate, and descent of the removal of the ashes is doubtless most rapid at the outside, *i. e.*, in the part nearest to the talus which is actually raked out; and because the ashes here descend the fastest, so should the overlying fuel. Thus the imaginary boundary between the burning fuel and the ash should be somewhat as here sketched in

* U. S. Patent, re-issue, 11,323, Jan. 28, 1896, The Duff Patents Company, 924 Carnegie Building, Pittsburgh, Pa.

Fig. 118. By making the ash-bed very deep this irregularity is kept within harmless limits.

326. THE USE OF STEAM IN THE PRODUCER. — In § 323, p. 425, we saw that the use of steam as a means of forcing the blast into the gas producer lessened the formation of clinker, thus both facilitating the cleaning of the fires and lessening the mechanical loss of fuel. A further and probably very great advantage is that it increases the quantity of combustible gas obtained from each ton of coal.

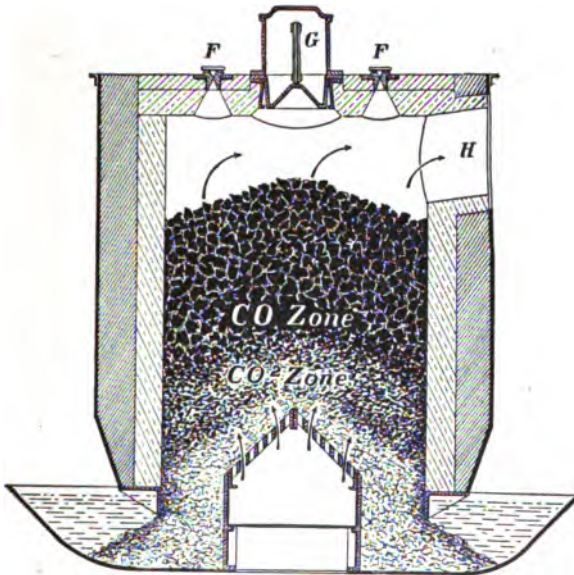

Fig. 118. The Duff Water-sealed Gas Producer.

For, whereas each equivalent of carbon gasified in the producer by atmospheric air gives only one equivalent of carbonic oxide ($C + O = CO$); each equivalent gasified by steam by the reaction $C + H_2O = CO + 2H$ yields in addition to this two equivalents of hydrogen. And whereas the gas made by means of air, the true producer gas, is diluted with the atmospheric nitrogen, that made by means of steam, the water gas of the producer, is not thus diluted. Of course, the total quantity of heat to be obtained from a ton of fuel is not changed; but the use of steam causes an absorption of heat in the producer, to be restored

in the working chamber by the combustion of the additional hydrogen formed in the producer at the expense of the heat thus absorbed. Manifestly, a calory evolved directly in the working chamber is more efficient than had it been evolved in the producer, because if evolved in the producer it would be in considerable part dissipated in bringing it forward into the working chamber.

Of course the gasification of the fuel in the producer requires that the fuel itself be hot, otherwise it will react neither on air nor on steam; the temperature must be kept up to the range in which both the atmospheric oxygen and the steam itself will react on the fuel and gasify it. But in the producer itself any heat over and above that needed to keep up this temperature is not only less efficient than if that same heat was generated in the working chamber of the furnace, because in passing from the producer to the furnace much of it would be wasted, but positively injurious because it tends to melt the ash into unmanageable clinker. Introducing steam along with the air used in gasification then stores energy in the producer by there utilizing part of the locally inefficient and harmful excess of heat, increases the quantity of combustible gas formed, and so restores that energy in the working chamber of the furnace where that excess of gas is in turn burnt. In short, it absorbs heat in the producer where it is harmful, and reproduces that heat in the working chamber of the furnace where it is used most efficiently.

Producers are often run now in such a way that the gas contains 5 or 6 per cent of carbonic acid, and this is not considered a loss of energy provided that much steam is used. The explanation of this is as follows: All the heat required in the producer is enough to keep up the temperature to the point of ignition of the coal. The amount of steam we can use is limited by this: it must not cool the temperature below that point. Manifestly, if we burn part of the carbonic oxide to carbonic acid we get thereby more heat in the producer, and this extra heat enables us to decompose just so much more steam without dragging the temperature below the needed point. Thus, in this sense the increase of carbonic acid does not necessarily represent a loss of energy, but merely that part of the energy, instead of being delivered in the form of carbonic oxide, is delivered in that of hydrogen.

APPENDIX I

327. FURTHER NOTE ON THE CONSTITUTION OF GRAY IRON.—As the conception of matrix and graphite is fundamental to the theory of the constitution of cast iron adopted in this work, it is important that it should be grasped firmly. To this end the following series of suppositious cases is here elaborated.









Case 1. Suppose that, within a strong iron mould, stands a cylinder of quartz, quite as the cylinder of white cast iron in Fig. 119*A* stands within its mould. Suppose, next, that this ingot is shattered by a powerful blow from above, but that its fragments remain in the mould, like those of the white cast iron in Fig. 119*B*. Then suppose that liquid asphalt or Portland cement is run into the crevices so as to fill them completely, as sketched in Fig. 119*C*, and that the whole is allowed to solidify.

Here we have a conglomerate of which the matrix is quartz and the cementing or filling matter is asphalt or Portland cement. Let this illustrate clearly what is meant by a matrix.*

328. *Case 2.* Next, let us suppose that the cylinder of quartz is replaced by a cylinder of white cast iron, Fig. 119*A*; that this in the same way is shattered as at *B*; that, by some means not explained, graphite is closely packed into all the crevices between the particles of iron, as at *C*, and that it cements them firmly together like the asphalt of Case 1.

* Matrix, "that which contains or gives shape or form to anything;—(Geol.)—or the mass in which a fossil or mineral is imbedded." *A Standard Dictionary of the English Language*: Funk and Wagnalls Company, 1898, p. 1090.

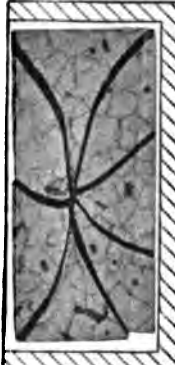
I am not wholly satisfied with this word "matrix" for expressing the conception to which it is applied in this work, especially because in the not wholly dissimilar case of concrete it is the filling of cement or other material which is called the matrix. The filling of a concrete forms a much larger proportion of the whole than the filling in our present series of cases; and the use of the word matrix is, as I understand it, governed rather by homology than by analogy. Hence the apparent discrepancy. The sense in which I use "matrix" in this work is related closely to the sense in which it is used in geology and mineralogy; at the same time, a better word is needed to express this idea. I use matrix simply because I do not think of any better word.

Solid Ingot	<p style="text-align: center;">CASE 2</p>  <p style="text-align: center;">A. White Cast Iron Ingot</p>	<p style="text-align: center;">CASE 3</p>  <p style="text-align: center;">D. White Cast Iron Ingot</p>	<p style="text-align: center;">CASE 4</p>  <p style="text-align: center;">G. White Cast Iron Ingot</p>
Shattered Ingot	 <p style="text-align: center;">B. Shattered Ingot</p>	 <p style="text-align: center;">E. Shattered Ingot</p>	<p style="text-align: center;">$Fe_3C = 3Fe + C$</p>
Graphite Filling or Segregate	 <p style="text-align: center;">C. Shattered Ingot with Extraneous Graphite Filling</p>	 <p style="text-align: center;">F. Shattered Ingot with Indigenous Graphite Segregated</p>	 <p style="text-align: center;">H. Solid Ingot with Indigenous Graphite Segregated</p>
Matrix Filling Segregate	<p>White Cast Iron (C. assumed to be 4%)</p> <p style="text-align: center;">Extraneous Graphite</p>	<p style="text-align: center;">Ferrite, Fe = Soft Steel</p> <p style="text-align: center;">Indigenous Graphite</p>	<p style="text-align: center;">Ferrite, Fe = Soft Steel</p> <p style="text-align: center;">Indigenous Graphite</p>

Here, again, we have a conglomerate, of which the matrix is white cast iron and the filling is graphite. But this conglomerate itself taken as a whole would be gray cast iron. It would, indeed, contain more carbon than any cast iron actually contains; but nevertheless because it contains more than two per cent of carbon such an imaginary substance would be cast iron; and it would be gray, because, if it was broken open, rupture would travel through the crevices filled with graphite, so that graphite alone would be seen in the fracture. The essential point to which attention is directed is that this conglomerate called gray cast iron is composed (1) of a matrix which is white cast iron and (2) a filling which is graphite.

329. *Case 3.* Next suppose that a like cylinder of white cast iron (*D*) is shattered (*E*), and that the crevices are filled and the fragments of iron are cemented together (*F*), not as in *C* with extraneous graphite, but with what we may call indigenous graphite; by which I mean graphite generated out of the fragments of the white cast iron matrix itself.

That such graphite should be thus generated we can readily conceive, in the following way. Let us first assume that the initial blocks of white cast iron contain 4.00 per cent of carbon and 96 per cent of iron, and that the whole of this carbon is united with $4 \times 14 = 56$ per cent of that iron to form $4 \times 15 = 60$ per cent of cementite. As there is nothing left for the remaining $96 - 56 = 40$ per cent of iron to be combined with, it must be present in the free state as ferrite; so that our white cast iron is composed initially of 60 per cent of cementite and 40 per cent of ferrite.

Let us next suppose that this 60 per cent of cementite decomposes, splitting up into 56 per cent of free iron and 4.00 per cent free carbon in the form of graphite, by the reaction

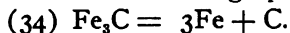

The free iron generated by this reaction is clearly ferrite by definition, since free iron and ferrite are one and the same thing; let us assume that each particle of it remains exactly where it came into existence, so that this 56 per cent of ferrite thus generated remains in the lumps of metal or matrix alongside of the 40 per cent of ferrite initially present. Let us further suppose that, by some unexplained means, the 4.00 per cent of graphite thus generated migrates out of the lumps of matrix inside which it was

born, and works its way out into the crevices between these lumps, filling them completely, and cementing the lumps together into a solid coherent whole or conglomerate. Here, as shown at *F*, the matrix of our conglomerate is ferrite, while the cement or filling is indigenous graphite.

Such a mass is clearly gray cast iron, for the same reasons as in Case 2.

Now, were some one to pick out these particles of ferrite, clean them scrupulously from adhering graphite, send them to a competent metallographist, and ask him whether this substance corresponded in composition to any familiar class of steel, he would have to reply that it was identical in composition with the most extreme type of soft steel, not only low in carbon but actually without carbon: in short, with the most dead soft steel. And, since the composition is that of such dead soft steel, doubtless the properties both chemical and physical are identical with those of such steel. So that, in this sense, the matrix of this conglomerate, the matrix of this gray cast iron, may be said to be equivalent to dead soft steel. This and the parallel constitution of the matrix under other conditions is what the upper line of Fig. 120 attempts to set forth; that the matrix of different cast irons is, in its composition and doubtless in its properties both chemical and physical, identical with some one member of the pearlite series.

330. *Case 4.* Finally let us suppose a somewhat similar course of events, omitting only the shattering. Let us suppose that a like block of white cast iron (*G*, consisting initially of [1] 4.00 per cent of carbon plus 56 per cent of iron, combined as cementite, and [2] 40 of ferrite), is heated up into region VII of Fig. 68, *i.e.*, to within a few degrees of the melting-point, so that it becomes extremely soft.

Let us suppose that the same reaction occurs, $\text{Fe}_3\text{C} = 3\text{Fe} + \text{C}$; that as before the resulting 56 per cent of ferrite unites with the 40 per cent of initial ferrite; and that the little particles of graphite which collectively constitute this 4.00 per cent of graphite are able to assemble themselves into little hexagonal flakes, say $\frac{1}{16}$ of an inch across shown very much magnified at *H*. This they are able to do by pushing aside the pasty mass within which they are born. This they do exactly as when any salt, say cupric sulphate, crystallizes out of an aqueous solution. Its individual molecules in assembling out of the solution into the form of solid crys-

tals, must travel a finite and sometimes a large distance through the water to meet the particles which have already assembled in the growing crystal, and in so traveling and assembling must push aside the water through which they travel and in which they assemble. The force, or the resultant of forces, which compels this traveling and assembling we may call the crystalline force, that which forces the particles to assemble themselves in crystals.

Now, these little flakes of graphite thus formed constitute a sort of skeleton running throughout the mass.

Here exactly as in Case 3, the block as a whole is a conglomerate, of which the matrix is ferrite and the filling is indigenous graphite. This filling is parallel or comparable with the graphite filling in cases 2 and 3; the difference is that in those two cases the graphite assembled in preëxisting crevices, whereas in Case 4 these crevices do not preëxist, but the graphite in assembling under the pressure of the crystalline force, pushes aside the soft metal in which it is born. But in spite of this difference the cases are parallel as far as the structural distinction of matrix and filling is concerned.

331. ACTUAL GENESIS OF WHITE AND GRAY CAST IRON. — §§ 327 to 330 have for their object to make clear this fundamental conception of matrix and filling. They have incidentally pictured conversion of white cast iron into gray (Case 4). Now, while it is true that in the process of making "malleable cast iron" (§ 227, p. 281), just this conversion of white into gray cast iron does occur on a very large scale, constituting the very essence of this process, and while the difference between white and gray cast iron is essentially just such a difference as would exist were gray iron thus habitually made out of white, yet the actual genesis of the common gray cast iron of commerce is quite different. It is not made out of white iron, but is the direct product of the solidification and cooling of the molten cast iron itself.

Thus, when molten, and as it runs from the iron blast-furnace, the cast iron contains much carbon (to fix our ideas let us continue to assume that this is 4.00 per cent) dissolved in the iron, as sugar or salt dissolves in water. The cast iron habitually contains other elements, especially silicon, phosphorus, sulphur and manganese. Ignoring these here for simplicity, let us consider our molten cast iron as consisting of 4.00 per cent of carbon dissolved in 96 of iron.

In the solidification and further cooling of this iron, the carbon may take either of two wholly distinct paths; or, as is habitual, some of it may take one of these paths and some the other (§§ 220 to 224, pp. 276 to 279).

Of these two paths one is that the carbon isolates itself within the pasty solidifying metal in the form of sheetlets of graphite, much as sketched in Case 4. This gives us "ultra-gray" cast iron, corresponding to the left-hand end of Fig. 120, p. 438. (See § 224.) Were all the carbon to do this, then the molecules of iron themselves being wholly free from carbon, would be ferrite; and the result would be the same as in Case 4, a conglomerate of which the matrix is ferrite and therefore identical in composition and properties with ultra low-carbon steel, and the filling is graphite.

The other path is that the carbon in freezing remains dissolved in the iron, as the solid solution austenite, which on cooling past Ar_1 , line PSP' of Fig. 68, is resolved into ferrite and cementite, Fe_3C (§ 223, p. 279). Here, by the same reasoning as in the second paragraph of Case 3, proportions of cementite and ferrite would be 60 per cent of the former and 40 of the latter. The whole mass is white cast iron, and the case is represented by the right-hand end of Fig. 120.

But habitually the case is intermediate between these two. Habitually part of the carbon passes into the state of graphite and part into that of cementite. To fix our ideas let us assume that 3.50 per cent becomes graphite and the remaining 0.50 per cent becomes cementite. The case then is represented by the 0.5 per cent carbon ordinate of Fig. 120. (It is not likely that so much of the carbon would pass into the state of graphite unless, as explained in § 224, the formation of graphite was stimulated by the presence of much silicon.)

Then our conglomerate as a whole is gray cast iron consisting of a filling of graphite, representing 3.50 per cent of the whole mass, and a matrix which by difference must represent $100 - 3.50 = 96.50$ per cent of the whole mass. This matrix contains all the 96 per cent of molecules of iron present, and also the 0.50 per cent of carbon which is in the condition of cementite which just adds up to the required 96.50 per cent.

What, now, is the constitution of this matrix?

With the 0.50 per cent of carbon existing as cementite must be combined $0.50 \times 14 = 7$ per cent of iron (§ 153, p. 182), so

that this matrix contains $0.50 + 7 = 7.50$ parts of cementite (7.50 per cent of the entire mass). The remaining $96 - 7 = 89$ per cent of iron contained in this matrix has nothing to combine with, and is therefore free iron, which by definition is ferrite. Thus the matrix consists of

cementite	$0.50 (1 + 14) =$	7.5	per cent
ferrite	$96 - 7 =$	89.0	“ “
Total matrix	96.5	“ “	

of the entire conglomerate.

Or looking at it in another way, the matrix contains 0.50 per cent of combined carbon. But Table 6, p. 184, shows us that this is the constitution of medium hard steel; and it is familiar to all that this is essentially the composition of rail steel, save that the latter habitually has in addition considerable manganese by intent and some phosphorus, sulphur and silicon in spite of us. We can then say that the cast iron as a whole is a conglomerate consisting of a graphite filling forming 3.50 per cent of the whole, and a matrix forming 96.50 per cent of the whole; and that this matrix is in composition and doubtless in properties the equivalent of rail steel of 0.50 per cent of carbon, a member of the pearlite series. This is indicated in the upper line above Fig. 120, above the 0.5 per cent carbon ordinate, and the fact that the cast iron as a whole is a very open gray one is indicated in the next lower line above that figure.

And so we could go on and indicate the genesis and constitution of other grades of cast iron.

332. GENERAL DIAGRAM OF THE CONSTITUTION AND PROPERTIES OF CAST IRON OF 4.00 PER CENT CARBON. — Following out the general ideas on the constitution of cast iron which have been here set forth, Fig. 120 is an attempt to represent in a condensed form the properties and constitution of a series of cast irons all containing 4.00 per cent of carbon, but with varying distribution of that carbon between the states of cementite and graphite; and also to represent the constitution and properties of the matrix of that iron, together with what we may call the trade name of the class of iron to which the matrix corresponds. First the lines which in Fig. 59, p. 162, show the physical properties of the pearlite series, and those showing the proportion of ferrite and of cementite

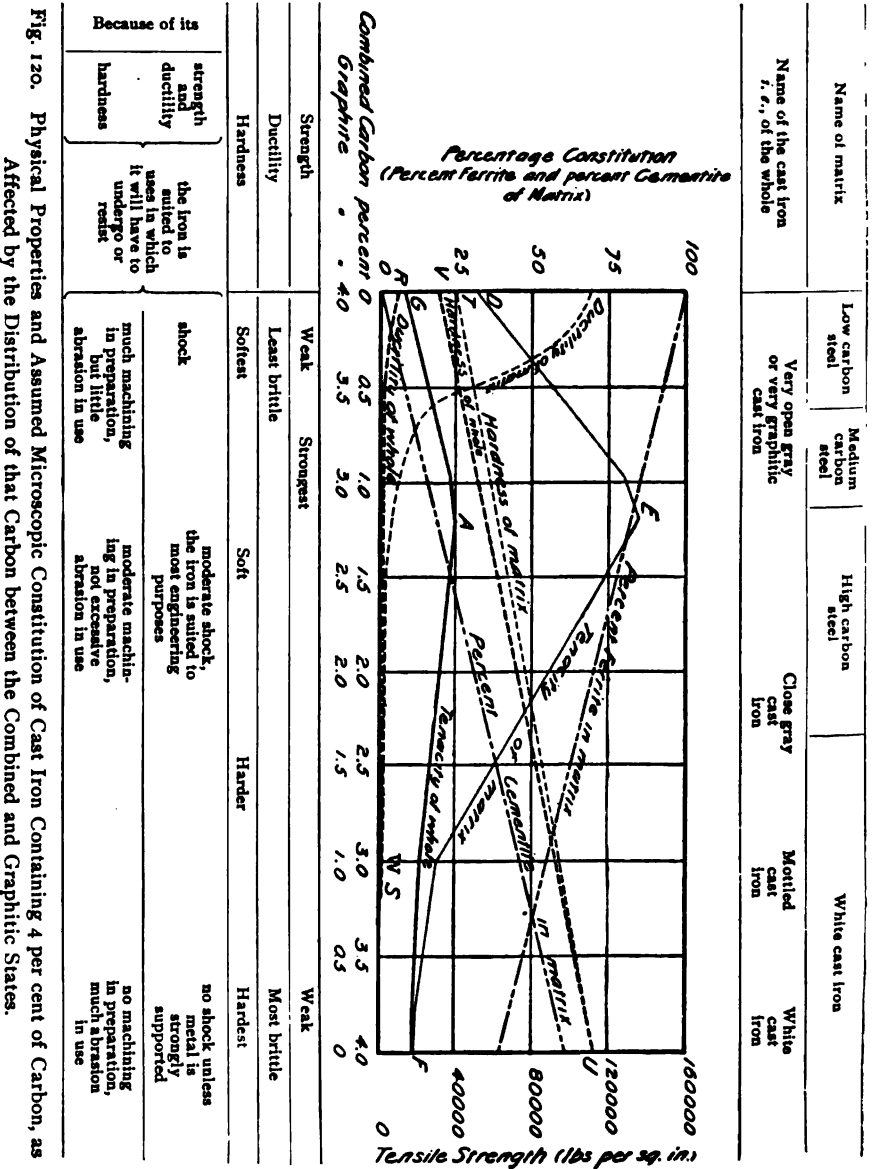

Fig. 120. Physical Properties and Assumed Microscopic Constitution of Cast Iron Containing 4 per cent of Carbon, as Affected by the Distribution of that Carbon between the Combined and Graphitic States.

in that series, are here reproduced, with the same lettering as in Fig. 59. These lines are supposed to show the constitution and properties of the matrix, for varying composition, *i.e.*, for varying carbon-content, of that matrix on the assumption that the properties of the matrix itself, its tensile strength, ductility and hardness, are the same as those of a graphiteless steel or a graphiteless white cast iron which has the same carbon-content and hence the same microscopic constitution as the matrix. For instance, a mottled cast iron containing 3 per cent of carbon combined as cementite, and 1 per cent of graphite, may be represented by ordinate *W* of Fig. 120. Table 6 shows us that the constitution of its matrix is ferrite 55 per cent, cementite 45 per cent, that of a white cast iron of the pearlite series. Accordingly, the lines in Fig. 120 which give the constitution of this matrix ("Per cent Ferrite in matrix" and "Per cent Cementite in matrix") cut this ordinate *W* at 55 per cent and 45 per cent, respectively. Next, Fig. 120 assumes that the properties of this matrix itself, as distinguished from the cast iron which contains it, are the same as the properties of such a white cast iron with 55 per cent ferrite and 45 per cent cementite; hence the line "Tenacity of matrix" cuts ordinate *W* at the same height as that at which it cuts the 3 per cent carbon ordinate in Fig. 59; and so with the lines "Hardness of matrix" and "Ductility of matrix."

These three lines, then, give us the tenacity, ductility and hardness, on the present hypothesis, of the matrix of each cast iron of this series shown in Fig. 120, as a basis for forecasting the properties of the cast irons themselves regarded as a conglomerate of (1) their matrix and (2) graphite; the properties of this conglomerate, *i.e.*, of the several cast irons each taken as a single conglomerate whole, are represented by the lines "Tenacity of whole," "Ductility of whole" and "Hardness of whole." These three lines are the result of a first attempt made by the author.*

Above the diagram is a line showing the trade name or grade of the cast iron as a whole, and above it a second line showing the nature of the matrix by what we may call its trade name. In other words, this line gives the trade names of the different classes of steel or cast iron to which the matrix corresponds in constitution, in different regions of this series. For instance, the words

* *Proc. Am. Soc. Testing Mats.*, II, 1902.

"Medium carbon steel" in this line mean that the matrix of the cast irons beneath these words has the same ultimate chemical composition and therefore, on our hypothesis, the same microscopic constitution, *i. e.*, the same percentage of ferrite and cementite, and also the same physical properties, which medium carbon steel has.

Below the diagram are given the observed properties of the different kinds of cast iron here represented, and the kinds of uses to which they are fitted.

APPENDIX II

Classification of Iron and Steel with Definitions

333. The classification and the definitions which follow are those used by Professor Albert Sauveur and the author, with much valuable advice from Mr. H. H. Campbell, in their work as a committee of the International Association for Testing Materials, to which thanks are due for permission to use this material here.

CLASSIFICATION

NAMES	APPARATUS IN WHICH USUALLY MADE
SPECIES	
Cast iron	Blast furnace.
<i>Varieties</i>	
White cast iron or pig iron . . .	Blast furnace.
Gray cast iron or pig iron . . .	" "
Mottled cast iron or pig iron . . .	" "
Pig iron (white, gray, mottled, etc.)	" "
Hot metal or direct metal . . .	" "
Basic cast iron or pig iron . . .	" "
Hematite cast iron or pig iron . .	" "
Malleable pig iron	" "
Washed metal	Pernot furnace.
Refined cast iron or plate iron . .	Coke refinery.
Charcoal hearth cast iron . . .	Charcoal hearth.
Alloy cast iron	Blast furnace, crucible or electric furnace.
SPECIES	
Malleable castings	{ Air furnace, open-hearth furnace, or cupola furnace, followed by long annealing.

NAMES	APPARATUS IN WHICH USUALLY MADE
<p style="text-align: center;">SPECIES</p> <p>Steel.</p> <p style="text-align: center;"><i>Variety A</i></p> <p>Called steel because cast initially into a malleable mass</p> <p>1, soft or low-carbon steel, or ingot iron</p> <p>2, half-hard and hard, or medium- and high-carbon steel, or ingot steel</p> <p style="text-align: center;">Sub-Varieties</p> <p>Bessemer steel</p> <p>Open-hearth steel</p> <p>Crucible steel or cast steel</p> <p>Steel castings.</p> <p style="text-align: center;"><i>Variety B</i></p> <p>Weld steel, or wrought steel, called steel because it is capable of hardening greatly by sudden cooling.</p> <p style="text-align: center;">Sub-Varieties</p> <p>Blister steel, also called cemented and converted steel</p> <p>Puddled steel</p> <p style="text-align: center;"><i>Variety C</i></p> <p>Alloy steels</p>	<p>Bessemer converter, open-hearth furnace, or crucible furnace.</p> <p>Bessemer converter.</p> <p>Open-hearth furnace.</p> <p>Crucible furnace.</p> <p>Cementation furnace.</p> <p>Puddling furnace.</p> <p>Open-hearth furnace, crucible furnace, or Bessemer converter.</p>
<p style="text-align: center;">SPECIES</p> <p>Wrought iron (or weld iron, or in Great Britain malleable iron).</p> <p style="text-align: center;"><i>Varieties</i></p> <p>Puddled iron</p> <p>Bloomary or knobbed iron</p>	<p>Puddling furnace.</p> <p>Bloomary, called also low hearth, charcoal hearth, Lancashire hearth, knobbling fire, etc.</p>

334. DEFINITIONS. — ALLOY CAST IRONS, those which owe their properties chiefly to the presence of an element (or elements) other than carbon.

ALLOY STEELS, those which owe their properties chiefly to the presence of an element (or elements) other than carbon.

BAR IRON, wrought iron in the form of bars, rods, etc.

BASIC PIG IRON. In America, pig iron containing so little silicon and sulphur that it is suited for easy conversion into steel by the basic open-hearth process. It is restricted to pig iron containing not more than 1.00 per cent of silicon.

BESSEMER PIG IRON, that which contains so little phosphorus and sulphur that it can be used by itself for conversion into steel by the original or acid Bessemer process. In America this term is restricted to pig iron containing not more than 0.10 per cent of phosphorus.

BESSEMER STEEL, steel made by the Bessemer process, whether its carbon content is high, low or intermediate.

BILLET, a small bar drawn from a pile, bloom, or ingot for further manufacture. The Committee recommends that the line between blooms and billets be drawn at the size of 5 inches square, as representing common custom.

BLISTER STEEL, steel made by carburizing wrought iron by heating it in contact with carbonaceous matter. It might also be made by so carburizing a low-carbon steel.

BLOOM. 1. A large bar, drawn from an ingot or like mass, for further manufacture. 2. A rough bar of wrought iron drawn from a Catalan or bloomary ball for further manufacture.

CAST IRON. Generically, iron containing so much carbon or its equivalent that it is not malleable at any temperature. Specifically, cast iron in the form of castings other than pigs, or remelted cast iron suitable for casting into such castings, as distinguished from pig iron, *i. e.*, cast iron in pigs, etc. (See Pig Iron.) For instance, cast iron pigs, *i. e.*, pig iron, like lead in pigs, *i. e.*, pig lead, is remelted and cast into castings, such as columns, locks, gears, etc., of special shape suited to their special purpose; these are specifically called "cast iron," and this is the usual restricted meaning of "cast iron" in trade language.

When we say "the fracture and density are those of cast iron," "the right-hand side of Roberts-Austen's diagram represents cast iron," or "Production of Steel by the Partial Decar-

burization of Cast Iron" (Percy, *Iron and Steel*, XV), we use "cast iron" in its generic sense, including both pig iron in pigs and cast iron in other and shaped castings, whether these are made direct from the molten pig iron running from the blast furnace, or by remelting that cast iron. On the other hand, when we say "cast iron locks, posts, and other hardware," we use "cast iron" in its specific sense of "shaped castings of cast iron," and we exclude pig iron. Exactly in the same way when we say "all men must die" or "the cavalry lacks horses," we use "man" and "horse" generically to include women and mares; when we say "the men are at the war" or "the horses beget colts," we use "man" and "horse" specifically, and exclude women and mares. The meaning of "pig iron," "woman" and "mare" is never in doubt; in which of its two meanings a word like "cast iron," "man" or "horse" is to be taken should be and generally is indicated clearly by the context. Dual meanings might conceivably lead to confusion, but in fact they do not; probably no reader of these present lines has ever been confused, unless intentionally, as to the meaning of "horse" or "man," nor need he be as to the meaning of "cast iron." Were your committee inventing language, it would avoid dual meanings; as our function is not to invent but to record existing language, we have no jurisdiction over the meanings of these words. We only assert our knowledge that the generic sense of "cast iron" is so firmly established in English literature that it cannot and should not be changed. That the trade itself rarely has occasion to make use of the generic meaning of cast iron would not warrant a vain attempt to root that established meaning out of scientific and literary usage. The trade need never use the generic meaning of "cast iron." The truth is that science and letters often need generic terms which trade does not need; "mollusc" is needless to the fish trade, "mammal" is needless to the circus trade, "conifer" is needless to the lumber trade; nevertheless those words and that sense will remain, because they are needed elsewhere.

The committee recommends drawing the line between cast iron and steel at 2.20 per cent carbon for the reason that this appears from the results of Carpenter and Keeling to be the critical percentage of carbon corresponding to the point "a" in the diagrams of Roberts-Austen and Roozeboom. As to the

signification of this critical point the committee is not prepared to express an opinion.

CAST STEEL, the same as crucible steel. Obsolescent, and to be avoided because confusing and because a temptation to fraud.

CEMENTED STEEL, the same as blister steel.

CHARCOAL HEARTH CAST IRON, cast iron which has had its silicon and usually its phosphorus removed in the charcoal hearth, but still contains so much carbon as to be distinctly cast iron.

CONVERTED STEEL, the same as blister steel.

CRUCIBLE STEEL, steel made by the crucible process, whether its carbon content is high, low or intermediate.

GRAY PIG IRON and **GRAY CAST IRON**, pig iron and cast iron in the fracture of which the iron itself is nearly or quite concealed by graphite, so that the fracture has the gray color of graphite.

HEMATITE PIG IRON, originally pig iron made from the hematite ores of England, which happen to be so free from phosphorus and sulphur that the pig iron made from them can be used by itself for the acid Bessemer process. By association it has come to mean any pig iron thus relatively free from phosphorus and sulphur. The term is not used in America, and is undesirable.

HOT METAL or **DIRECT METAL**, the molten cast iron from the blast furnace before it has been allowed to solidify.

INGOT IRON, steel cast into an initially malleable mass and containing so little carbon or its equivalent that it does not harden greatly on sudden cooling. The word is rarely used in English, "mild steel" or "low carbon steel" or "soft steel" being generally used in its place. In America the line between soft steel and half-hard steel is usually drawn at a carbon content of about 0.20 per cent.

INGOT STEEL, steel cast into an initially malleable mass and containing so much carbon or its equivalent that it hardens greatly on sudden cooling. The word is rarely used in English, but "hard steel," "high-carbon steel" or "half-hard steel" are used in its place.

MALLEABLE CASTINGS, castings of malleable cast iron, which see.

MALLEABLE CAST IRON, iron which when first made is cast in the condition of cast iron, and is made malleable by subsequent treatment without fusion.

Although the English name of this variety suggests that it

is cast iron, it is not truly a variety of cast iron, but rather forms an independent species of iron, because it lacks the essential property of cast iron, *viz.*, its extreme brittleness. Though the term "malleable castings" is very common, the term "malleable cast iron" is very rarely used. The common but inexcusable term we regret to say is "malleable," pronounced "mallable," used as a substantive. Those with some respect for their mother tongue, if asked of what material a malleable casting was composed, would generally use a circumlocution.

MALLEABLE IRON, the same as wrought iron. Used in Great Britain, but not in the United States, except carelessly as meaning "malleable cast iron" (vulgar "malleable").

MALLEABLE PIG IRON, an American trade name for the pig iron suitable for converting into malleable castings through the process of melting, treating when molten, casting in a brittle state, and then making malleable without remelting. The term should be used with care to avoid confusion. This material is also called in trade in America "malleable iron," but this use should be avoided, because "malleable iron" has the older and (in Great Britain) firmly established meaning of "wrought iron."

MOTTLED PIG IRON and **MOTTLED CAST IRON**, pig iron and cast iron the structure of which is mottled, with white parts in which no graphite is seen, and gray parts in which graphite is seen.

MUCK BAR, the rough bars, usually 1 inch thick and about 4 inches wide, made by the first rolling of a ball of puddled iron.

OPEN-HEARTH STEEL, steel made by the open-hearth process, whether its carbon content is high, low or intermediate.

PIG IRON, cast iron which has been cast into pigs direct from the blast furnace. This name is also applied to molten cast iron which is about to be so cast into pigs or is in a condition in which it could readily be cast into pigs.

PLATE IRON, a name applied in Great Britain to refined cast iron.

PUDDLED IRON, wrought iron made by the puddling process.

PUDDLED STEEL, steel made by the puddling process, and necessarily slag-bearing. (See Weld Steel.)

REFINED CAST IRON, cast iron which has had most of its silicon removed in the refinery furnace, but still contains so much carbon as to be distinctly cast iron.

STEEL, iron which is malleable at least in some one range of temperature, and in addition is either (a) cast into an initially malleable mass; or (b) is capable of hardening greatly by sudden cooling; or (c) is both so cast and so capable of hardening. Variety A includes also molten iron which if cast would be malleable, as do its two sub-varieties, "ingot iron" and "ingot steel." (Tungsten steel is malleable only when red-hot.)

STEEL CAST (adjective), consisting of solid Bessemer, open hearth, crucible or other slagless steel, and neither forged nor rolled: applied to steel castings. For instance, a "steel cast" gun is a gun which is a steel casting, *i. e.*, which has been neither forged nor rolled. To call it a "cast steel" gun would imply that it was made of crucible steel, to which the term "cast steel" is restricted.

STEEL CASTINGS, unforged and unrolled castings made of Bessemer, open hearth, crucible or any other steel. Ingots and pigs are in a sense castings; the term "steel castings" is used in a more restricted sense, excluding ingots and pigs and including only specially shaped castings, such as are generally used without forging or rolling. They may, however, later be forged, *e. g.*, under the drop press, when they cease to be "castings" and become "drop forgings," or if only part is forged then they are partly forgings and partly castings.

SLAB, a flat piece or plate, with its largest surfaces plane, drawn or sheared from an ingot or like mass for further treatment.

WASHED METAL, cast iron from which most of the silicon and phosphorus have been removed by the Bell-Krupp process without removing much of the carbon, so that it still contains enough carbon to be classed as cast iron. The name "washed metal" is extended to cover this product even if its carbon is somewhat below the proper limit for cast iron.

WELD IRON, the same as wrought iron. Obsolescent and needless.

WELD STEEL, iron containing sufficient carbon to be capable of hardening greatly by sudden cooling, and in addition slag-bearing because made by welding together pasty particles of metal in a bath of slag, as in puddling, and not later freed from that slag by melting. The term is rarely used.

WHITE PIG IRON, and **WHITE CAST IRON**, pig iron and cast

iron in the fracture of which little or no graphite is visible, so that their fracture is silvery and white.

WROUGHT IRON, slag-bearing, malleable iron, which does not harden materially when suddenly cooled.

WROUGHT STEEL, the same as weld steel. Rarely used.

335. THE BOUNDARY BETWEEN STEEL AND IRON. — It would be well to decide on a definite carbon-content to serve as a boundary line between ingot iron and ingot steel, between puddled iron and puddled steel, and between any other varieties of wrought iron and weld steel. Two plans have been considered. One is to draw this line at 0.32 per cent carbon or its equivalent in other elements, for the reason that this carbon-content appears to correspond to the critical point *H* in the diagrams of Roberts-Austen and Roozeboom. This has the merit of corresponding to a definite physical boundary.

The other plan is to draw the boundary at 0.20 per cent of carbon, because this is a convenient place to separate the important classes "soft steel" and "half-hard steel"; so that if this point was adopted, "ingot iron" would be synonymous with "soft steel," and "ingot steel" would be the equivalent of the two classes "half-hard steel" and "hard steel."

APPENDIX III

336. THE MAGNETIC PROPERTIES.* — As pointed out in § 193, p. 215, alpha iron, characteristic of slowly cooled iron and steel and normal below A_2 of Fig. 68, p. 192, is strongly magnetic, but the allotropic beta and gamma iron, the former stable between A_2 and A_3 and the latter above A_3 , are only feebly magnetic. And of alpha iron, it is probably the alpha ferrite which is the most strongly magnetic form.

The fact that as the carbon diminishes the temporary magnetism increases but the permanent magnetism or retentivity decreases, until in very low carbon steel and wrought iron the temporary magnetism is very great and the permanent magnetism is very low, may conveniently be explained by supposing that

* See Osmond, *Philosophical Magazine*, 5th series, vol. XXIX, p. 511, June, 1890. Also the author, *Trans. American Inst. Mining Engineers*, XXVII, 1897, p. 914.

temporary magnetism is due to the polarizing or rotating of the particles of alpha iron, especially of alpha ferrite, by the magnetizing force, and permanent magnetism to the locking of those polarized particles in their rotated position. In very low carbon steel there is little except alpha ferrite, little to restrain the particles of alpha iron from rotating under the influence of the magnetic field; hence the great temporary magnetism. But then there is nothing to hold the rotated particles in place after the magnetizing force has been removed, so that their elasticity quickly returns them to their initial position, and the magnetism temporarily induced quickly ceases; hence the small retentivity.

When such steel is quenched even from the austenite region, IV of Fig. 68, thanks to its being nearly free from carbon, which in higher carbon steels acts as a brake to retard the transformation, it changes into ferrite and cementite nearly as fully as if it were cooled slowly; and the completeness of this transformation which prevents such steel from hardening, in like manner prevents it from acquiring retentivity or greatly losing its capacity for temporary magnetism.

But high-carbon steel, even when slowly cooled, has comparatively little temporary magnetism, first because it has much less alpha ferrite, and next and chiefly because the rotation of that alpha ferrite by the magnetizing force is impeded perhaps in part by the cementite, but probably chiefly by the beta or gamma iron which the presence of carbon has prevented from changing into alpha iron, even in the ample time which the slow cooling has offered.

On the other hand, such steel when cooled suddenly has very great retentivity, or permanent magnetism, because, once the particles of its alpha iron have been rotated, the beta or gamma iron, present because restrained by the suddenness of cooling from transforming into alpha iron, acts as a brake to hold those particles in this rotated position after the magnetizing force has ceased to exist.

APPENDIX IV

Some Metallurgical Novelties

336 A. ROE'S ROCKING PUDDLING FURNACE,* Fig 121, consists of a puddling chamber which, with its converging quadrant-

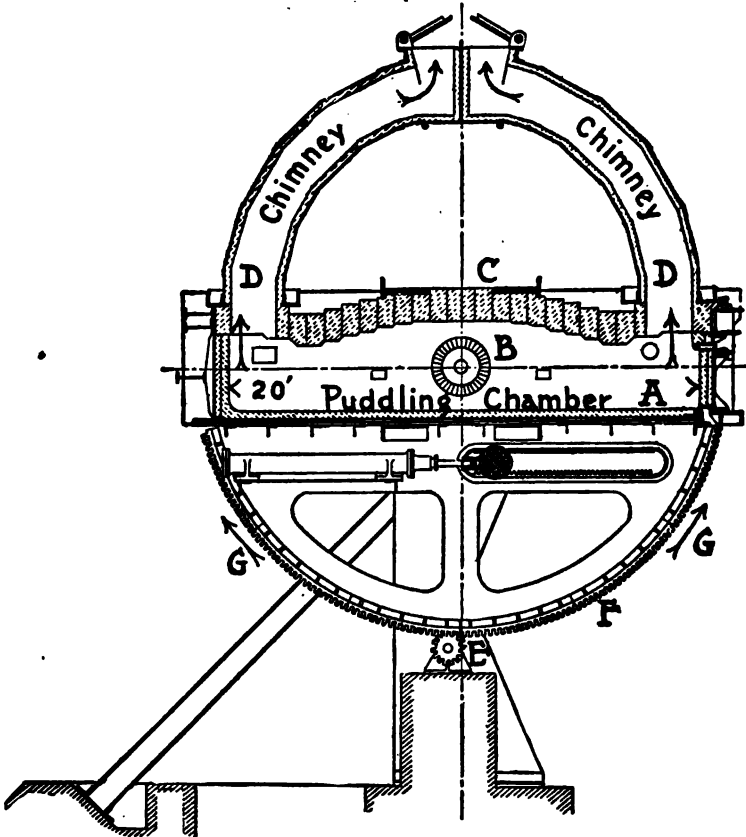

Fig. 121. Longitudinal Vertical Section of Roe's Rocking Puddling Furnace.

A, the magnesia brick lining of the puddling chamber, which is about 20 feet long and 8 feet wide. B, hollow trunnion, about which the whole machine, chamber, chimneys and all, rocks. There is of course a second trunnion on the opposite side of the furnace, with its axis in line with the axis of the one here shown. Through these trunnions the oil flame, the only source of heat, is brought. C, fire brick roof of the puddling chamber. D, D, converging chimneys rocking with the furnace. E, pinion which rocks the furnace by means of the semicircular rack F. G, G, arrows to show the direction of rocking.

* *Trans. Am. Inst. Mining Engineers*, XXXIII, pp. 551-561, 1903;

shaped chimneys, rocks about 65 degrees back and forth in the direction shown by the arrows *GG*, around the hollow trunnions *B*, through which an oil flame to heat the whole is brought. This rocking, varied to suit the different stages of the puddling process, hastens the oxidation and removal of carbon, silicon, etc., the essence of puddling, by repeatedly mixing the very oxidizing slag or "cinder" with the metal, making them run down hill, first to the right and then to the left; and it later rolls or coaxes the resultant pasty wrought iron into one large 4,000-pound ball. This is next shot directly into a special squeezer, in which under a pressure of some 1,800 tons its cinder is squeezed out, and it is then immediately rolled out into billets or slabs, or even, we are told, into finished bars. The puddling chamber is lined with magnesia bricks *A* resting on a water-cooled iron bottom, and wears away but slowly. Molten cast iron, preferably direct from the blast furnace, is treated, and roll scale, the very rich iron oxide which falls from the surface of iron or steel while rolling, is used as the active oxidizing agent, reinforced of course by the atmospheric oxygen, and mixed with puddling "tap cinder," a very basic iron silicate.

Mr. Roe claims a great saving in cost (1) through avoiding the extremely trying and therefore expensive labor of hand puddling; (2) through treating much larger charges, 4,000 pounds against the common 1,100-pound charge of the double hand-puddling furnace; (3) through treating much larger balls, 4,000 pounds against the common 180-pound hand-puddled ball; and (4) through lessening the loss of iron through oxidation, because the great size of the ball implies a correspondingly small proportion of surface exposed to the oxidizing action of the air in squeezing, reheating and rolling. The most evident disadvantage is the cost of installing this costly mechanism.

Why, we may well ask, should this puddler be expected to succeed, when the many mechanical puddlers of the past, including those of Danks and of Pernot which gave such great promise, have failed?

Two fields were open to these older puddlers; first that of turning phosphoric pig iron, which before the invention of the

Idem, XXXVI, to appear; *The Iron Age*, June 15, 1905, pp. 1896-1899; U. S. Patent, No. 659,698.

basic Bessemer and open-hearth processes could not be used for steel making, into dephosphorized puddled iron, a product well suited for turning into steel by the acid open-hearth process. Second, of making wrought iron to be used as such, after rolling out into plates or bars.

The first of these fields is no longer open, because since those days the basic open-hearth process has grown to be a much cheaper way of turning phosphoric pig iron straight into steel.

In the second of these fields the older mechanical puddlers failed because their product was too heterogeneous, in that the different parts of a single bar or plate differed too greatly in composition and properties. This in turn was due to three faults, first that the action of the furnace was such as to give a raw centre to each ball; second that the lining of the furnace was of a kind which broke off and became inextricably mixed up with the puddled product; and third that the cinder or slag in which the puddled ball was formed could not be sufficiently squeezed out. These three troubles Mr. Roe promises to overcome, as I will now try to explain.

To study the defects of the many dead puddlers would take us too far; but we may well glance at those of the Danks and Pernot puddlers, in order to see how it is that Roe may hope to win where they lost.

The Danks puddler was like a barrel lying on its side and turning about its own axis; the Pernot like a saucer a few degrees out of level, and spinning slowly around what we may call its axis, the axis about which a juggler spins his saucers and plates. The turning of the furnace exposed fresh surfaces of the initially molten pig iron to the oxidizing cinder, rich in iron oxide, mixed up cinder and iron, and so brought about the oxidation of carbon, silicon, and phosphorus, by means of the oxygen of the iron oxide. All went well as long as the pig iron remained molten; but as soon as any part of it had lost so much carbon that it was no longer quite liquid but had begun to be pasty, these pasty particles stuck together, and now the trouble began.

If the furnace stood still, only the upper surface of the iron would be acted on by the cinder, and this would surely make the product very uneven; therefore the furnace had to be kept turning, in order that the purification through oxidation should go on. But this turning carried things from bad to worse, because it

necessarily made the pasty particles glue together into a crude ball, and the material in the inner part of the ball was well shut off from all further oxidation by the layers outside it. When the iron first begins to glue itself together it is still far from thoroughly purified; it is still relatively raw; so that the middle of the incipient ball was necessarily raw; and this local rawness could not well be cured by any further treatment, but persisted in the bars and plates made by rolling out that ball.

This first trouble Mr. Roe meets by the flatness of his hearth, on which the iron, as it begins to grow pasty, may spread out in a thin layer, exposed with some approach to evenness to the action of the cinder. The iron, as it grows progressively more and more pasty, slides rather than rolls. At least the motion is more of a slide and less of a roll than in the Danks barrel and the Pernot saucer; and in as far as we replace a roll with a slide, in so far do we lessen the tendency to wrap raw parts up and seal them under blankets of impenetrable iron, and thus to cut them off from further cure, from further purification by the oxidizing molten cinder.

The next trouble, that pieces of the lining of the furnace broke off and were mixed up with the puddled iron, out of which they could not be got, Mr. Roe cures easily by substituting for the rough and brittle iron ore lining of the older puddlers a newer material, the magnesite bricks which the progress of steel making has developed into a most valuable material. They are strong, smooth, and coherent. Instead of breaking off they wear away, but only slowly as we are credibly told. This second betterment, then, he owes to the progress of steel making.

The third trouble, that the cinder cannot be well squeezed out of a large single ball, and such a ball the rolling, rocking, or turning puddling furnace almost necessarily makes, Mr. Roe meets first by the bold step of shooting the ball straight from the furnace into the jaws of a traveling squeezer, without chance to cool in going from distant furnace to central squeezer and while waiting its turn there; and second by making this squeezer a real bear, in the strength of its grip. It moves about from puddler to puddler, to swallow the great 4,000-pound ball at the instant when the furnace shoots it forth.

Each ball is so uniform throughout, thanks to the outspreading of the mass on the flat floor of the puddler, and is so free

from cinder, thanks to the high temperature at which the squeeze begins and to the intensity of that squeeze, that Mr. Roe thinks that the squeezed ball ought to be rolled straight into bars or plates, instead of being rolled into muck bar, cut up, piled, re-heated, and re-rolled, like the product of the common hand puddler.

To recapitulate, the chief advantages which the Roe has over the older mechanical puddlers are

(1) that it seeks to avoid having a raw centre in each ball, by spreading out the mass thin and somewhat even on the flat hearth until thoroughly ready for balling and squeezing, and by replacing a roll with a slide;

(2) that the lining is smooth and coherent, so that it does not break off and contaminate the product;

(3) that, thanks to the intensity of the squeeze and to shooting the ball at full heat straight from furnace into squeezer, the cinder is so thoroughly squeezed out that the ball may be rolled at once with its initial heat into bars or plates.

337. THE MOND GAS PRODUCER, Fig. 122, is a modification and elaboration of the common water-sealed air- and steam-blown gas producer,* yielding a mixture of hydrocarbons from the distillation of the freshly charged coal at the top, and carbonic oxide, hydrogen and nitrogen resulting from final combustion of the coal at the bottom of the producer by a mixed stream of air and steam. The modification consists essentially in keeping the temperature low and the proportion of hydrogen in the gas high by raising to its highest practicable limit the proportion of steam which is mixed with the air blown into the bottom of the producer, and by other means, all with the purpose of having in the gas the largest practicable quantity of ammonia NH_3 . The steam both lowers the temperature through its endothermic decomposition by the glowing coal,†

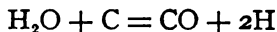

and by this same reaction leads to the presence of much hydrogen in the gas; and both the low temperature and this hydrogen favor the formation of ammonia, or at least restrain its decomposition.

The quantity of steam which may be mixed with the air blast

* See §§ 323-326, pp. 423-430, and especially Fig. 118, p. 429.

† § 326, p. 429.

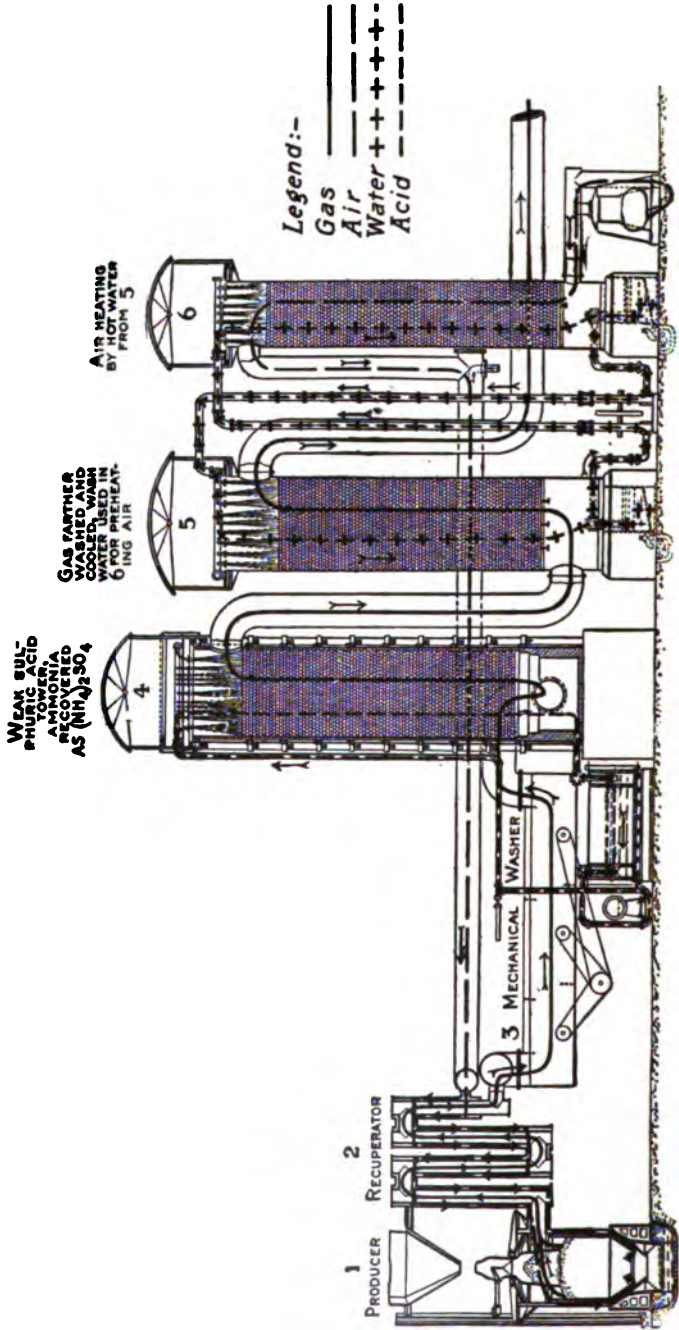

Fig. 122. Diagram of Mond Gas Plant with By-Product Recovery.

is limited only by the consideration that it must not put the fire out by cooling the coal below its ignition temperature. Hence preheating the mixture of steam and air, in that it tends to raise the temperature of the combustion zone at *B*, Fig. 123, enables us to increase the quantity of steam proportionally.

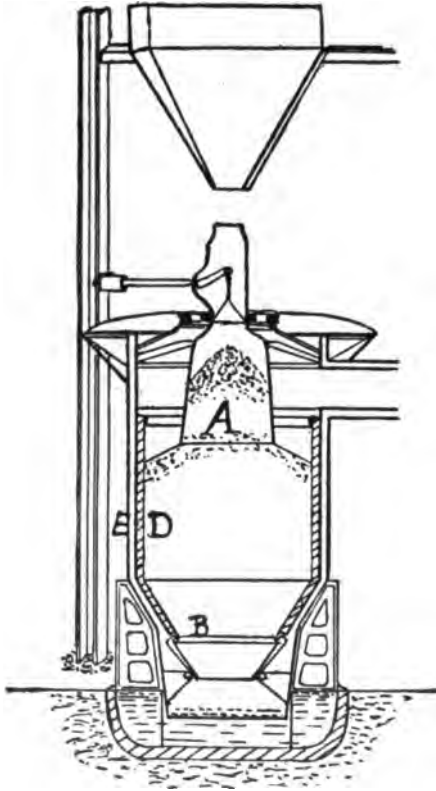

Fig. 123. The Mond Gas Producer.

In order to see how the air is mixed with steam, and how this mixture is preheated, we will first follow the passage of the air from right to left in Fig. 122; and to see how the ammonia is recovered from the gas we will then follow the path of that gas from its formation in the producer at the left, to its delivery at the right for burning in metallurgical furnaces.

The air, blown in at the bottom of tower 6, is saturated with steam and receives its initial heating by passing up through this

tower, in which it meets a shower of hot water which has just been preheated by showering down through the rising stream of hot gas in tower 5. The air thus preheated, and the steam with which it has thus been mixed, are further heated, first by passing them through the annular space between the outer and inner concentric pipes of the iron pipe-recuperator 2, while through the inner pipes passes the hot gas direct from the upper part of the producer; and second, by passing them through the annular space between the iron outer wall *E*, Fig. 123, and the cylindrical fire brick inner wall *D* of the producer itself, which they next enter at *B*.

Turning now to the gas, let us first note the deep-reaching central cylinder *A*, Fig. 123, which, with the annular outer space, constitute the chief distinctive features of the producer. In this cylinder the coal lies when first charged, and here its volatile matter is gradually distilled at a very low temperature, thanks to its distance from the combustion region, to its being shielded from the stream of gas rising hot from that region, and to the cooling of the upper part of the producer by the steam and air which circulate through the annular space between *D* and *E*. This low-temperature distillation, as already pointed out, favors the formation and preservation of ammonia.

The gas thus distilled, mixed with the carbonic oxide and hydrogen rising from the region of combustion, sweeps forward from the upper part of the producer through the recuperator 2 already noted; through the mechanical spray washer 3, in which soot and some tar are deposited and the ammonia is converted into ammonium hydroxide, NH_4HO , and mixed with much water vapor; into the tower 4, in which a stream of weak sulphuric acid converts the ammonium hydroxide into ammonium sulphate, which it condenses,

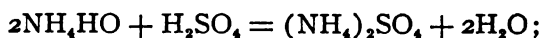

then up through tower 5, in which the stream of gas gives up the rest of its heat, and also of its tar, to the shower of water already described. The water thus heated next passes, after its tar has been removed, to give up to the incoming air in tower 6 the heat which it has just recovered from the producer gas in tower 5, and it continues in this circle, alternately storing heat from the gas in 5 and restoring it to the air in 6.

The ammonium sulphate liquor from tower 4 is passed repeatedly through this same tower until it contains about 36 per cent of this sulphate, which is then recovered in the form of crystals by evaporation and crystallization.

Because the demand for the ammonium sulphate for agricultural purposes ought to be practically unlimited, this by-product should be of great value. But against the great advantage of its easy and nearly complete recovery must be weighed the serious cost of installation and the apparently bad quality of the producer gas, if we may judge from the published analyses.

338. THE GAYLEY DRY-BLAST PROCESS.* — In order to condense the moisture out of the air or blast used in the iron blast-furnace, and thus to dry it, Mr. James Gayley passes it around large coils of iron pipes through which a freezing mixture circulates, and then heats it in the usual way by blowing it through hot-blast stoves. In order to remove the snow which gradually encrusts the outside of the pipes, he passes hot brine through a few of them at a time, when their snow quickly melts and is drained away. This simple drying of the blast saves about 19 per cent of the fuel, a quantity altogether disproportionate to the apparent reduction of the calorific demands which it brings about; and it also makes the action of the furnace much more regular. It lowers the temperature of the gases which escape from the top of the furnace, and raises their percentage of carbonic acid, natural results and indeed symptoms of the great increase in fuel efficiency.

It has long been recognized that the atmospheric moisture in the blast, because it has to be decomposed by the well-known endothermic reaction (31), $H_2O + C = CO + 2H$, has a very appreciable cooling effect on the lower part of the furnace, just where the most intense temperature is needed in order to melt the iron and slag, remove the sulphur, and deoxidize the silicon; and it has long been known that the blast-furnace needs more fuel in warm and especially in damp weather than in cold and dry weather, much more in summer than in winter, and that a weather change from cold and dry to warm and damp, unless met immediately by increasing the heat available in the hearth of the furnace, quickly lowers the temperature there and so makes

* *Jour. Iron and Steel Inst.*, 1904, II, pp. 274-300; 1905, I, p. 256; *Trans. Am. Inst. Mining Engineers*, XXXV, 1905, p. 746.

the iron richer in sulphur and poorer in silicon, by impeding the removal of sulphur and the deoxidation of silicon, both of which need a high temperature. But that the gain to be had by drying the blast could be as great as Mr. Gayley has shown not only was unforeseen but, when reported with every detail and warrant of veracity, was promptly rejected by many learned metallurgists as absurd.

339. REASONS FOR THE FUEL SAVING. — That removing the variations in the cooling effect of the moisture in the blast by removing the moisture itself should remove a grave cause of irregularity in the working of the furnace, needs no explanation. And that removing a refrigerating substance like moisture from the blast should bring about a fuel-saving far greater than that immediately due to saving the heat needed for its decomposition and heating, becomes clear enough on careful study. The several causes which combine to bring about this at first sight surprising effect can be understood best by looking backwards, taking first the condition of the furnace when using dried blast, and then seeing how this condition is affected by changing from dried to common moist blast. Looking at the subject in this way, it seems to me that the chief reasons why the presence of moisture in the blast increases the fuel consumption so very greatly are these:

First, that, by lowering the temperature developed by combustion in the hearth, it cuts out a large fraction of the relatively narrow margin between the combustion temperature and the "critical" temperature at and above which much of the "critical" work of the furnace (a term to be explained shortly) must be done, and thus lessens proportionately the heat available for that critical work.

Second, this combustion temperature is further lowered, the margin between it and the critical temperature is further narrowed, and the heat available for the critical work thereby further lessened, by the lowering of the temperature of blast which the use of moist blast itself brings about. In Mr. Gayley's case this lowering of the temperature appears to be due to the greater quantity of blast to be heated in stoves of a given size, and not to any increase in the ratio of the weight of blast to be heated to the weight of gas which is to heat it, because there appears to be no material change in the percentage of nitrogen in the waste gases. Indeed the facts seem to indicate that, with moist blast,

his hot blast stoves are overloaded, because, although the ratio of heating gas to blast to be heated seems almost the same with dried as with moist blast,* and although the heating gas is much richer in carbon monoxide, yet the blast was not heated so hot in case of moist as in that of dried blast. This seems to show that an important part of the saving brought about by drying the blast could have been effected by increasing the size of the hot blast stoves.

Third, that, to supply the extra heat which is needed, not only for making good the loss just noted in the heat available for the critical work of the furnace, but also to make good the heat abstracted by the dissociation of the moisture, calls for an altogether disproportionate increase in the fuel consumption, because only a small proportion of the heat developed by this extra fuel can be utilized, with the consequence that so much of this heat as is not utilized must still be present in the waste gases when they escape from the top of the furnace and thus be lost: hence the lowering of the temperature of these gases which Mr. Gayley causes by drying the blast.

Fourth, that this increase, due to moisture in the blast, in the temperature of the gases escaping from the furnace top necessarily causes them more vigorously to attack, dissolve, and carry away the incoming coke by the reaction

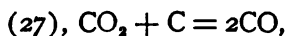

to meet which robbery of coke additional fuel must be charged.

* This is easily shown. The composition of the waste gases escaping from the top of the furnace was as follows:

	WITH DRIED BLAST	WITH MOIST BLAST
Carbon monoxide	19.9 per cent	22.3 per cent
Carbon dioxide	16.0 "	13.0 "
Nitrogen and hydrogen, by difference .	64.1 "	64.7 "
	<hr/>	<hr/>
Total	100.0 per cent	100.0 per cent
Gas temperature	376° F.	538° F.

Thus the quantity of nitrogen per 100, or per unit, of gas was not changed by changing from moist to dried blast, which is the same as saying that the quantity of gas per unit of nitrogen was not changed. But as the nitrogen comes wholly from the blast, and as the quantity of nitrogen per unit of blast is constant, this is the same as saying that the quantity of gas per unit of blast to be heated by that gas was not changed.

340. DISCUSSION. IMPORTANCE OF INITIAL GAS TEMPERATURE IN HEATING PROCESSES WITH A CRITICAL TEMPERATURE.— Let us now study these reasons, and first let me explain the meaning of "critical" as here used, by the case of the boiling of water.

Here the heating work naturally falls into two distinct parts, that of heating the water from its initial temperature, say 0°C. , to its boiling point, which requires relatively little heat; and second that of boiling it at atmospheric pressure, by making good the heat made latent by the boiling, which calls for 5.36 times as much heat. The boiling point may here be called a critical point, and the work of boiling the water critical work; it is work which has to be done by heat supplied from above this critical temperature.

The importance of the idea may be seen by comparing this operation of boiling water with one which has no critical temperature, such as heating a column of copper balls enclosed in a vertical shaft with adiabatic walls (i. e., walls through which absolutely no heat escapes), to $1,000^{\circ}$ by means of a stream of heated gas passing up through that column. Let us assume that each ball is withdrawn as soon as it reaches $1,000^{\circ}$, but not before. Ignoring here and throughout this discussion the variations of specific heat due to variations in temperature, the same quantity of heat is required to raise a gramme of copper through one degree at a low temperature as at a high temperature; the same quantity is needed for each and every degree rise of temperature.

Here recognize clearly that efficient heating, i. e., thorough utilizing of the heat contained in the heating gases, means that the conditions are such that the heat initially in the heating gases is transferred nearly fully to the copper balls, so that those gases, before leaving the balls, have their heat thoroughly removed by those balls, i. e., become thoroughly cooled. Note carefully these last three words. The heat in the escaping gases proves as clearly that it has not been utilized as the cake in my hand proves that it has not been eaten. What I still hold I have not parted with.

Now, in order that this transfer of heat from gas to balls under these conditions shall be nearly complete, the only requirement as far as the initial temperature of the gas is concerned is that it shall be above $1,000^{\circ}$. If it is but little above $1,000^{\circ}$, much gas and much opportunity for heat transference, i. e., very prolonged contact, are needed; if it is very far above $1,000^{\circ}$, pro-

portionally less are needed. Here quantity of heat can make up for what temperature lacks, provided only that there is some margin between the initial temperature of the gas and the final temperature which the balls must reach.

A large margin is indeed somewhat better than a small one, but a small one will suffice. Lot 1 of 50 grammes of gas at $1,100^{\circ}$ contains as much heat as lot 2 of 25 grammes at $2,200^{\circ}$, and theoretically and roughly speaking, the heat contained in lot 1 should be nearly as well utilized as that in lot 2, in passing through the column of copper balls, i. e., nearly as great a proportion of that heat should pass into the copper balls in the upward journey between them, in case of lot 1 as in that of lot 2. Quantities of heat are here of chief importance, and initial gas temperature is of secondary moment, provided only that it is above the temperature to which the copper must be heated.

Of course, to recover the heat of lot 1 needs a longer column of balls than would suffice to recover the heat of lot 2 with equal thoroughness, because if the same quantity of balls is to be heated per hour, the quantity per hour of gas of lot 1, and therefore the rate of travel, must be twice as great as those of lot 2. Further, cooling these two lots of gas to the same temperature, say 110° , would still leave unrecovered, and therefore unused, twice as large a percentage of the initial heat in lot 1 as in lot 2. In short, the recovery of the heat from lot 1 cannot readily be made quite as thorough as from lot 2; and in order to make it even approximately as thorough, there must be much greater opportunity for heat transference.

But the influence of initial temperature may be of a wholly different order of magnitude in operations with a critical temperature; in these, initial temperature may be as important as quantity of heat. Thus, not even an infinite quantity of gas at 99° can boil one single gramme of water at atmospheric pressure. If the work of heating and boiling is to be done by the heat contained in a stream of gas, for instance in the gaseous products of the combustion of a boiler fire, it is only by as much as that gas is above 100° that it can boil water.

If gas is initially at 101° , it can give up only about 1 per cent of its heat to the work of boiling water as distinguished from heating that water towards the boiling point; because as soon as it has given out that one per cent and has thereby cooled to 100° ,

it ceases to be able to transfer its heat to water already at 100° . If the initial gas temperature is 105° , approximately five per cent of the heat developed can thus be utilized theoretically in boiling water; if at $1,000^{\circ}$, 90 per cent can thus be utilized theoretically. Thus raising the initial temperature from 101° to 105° , or by only about four per cent, increases by about 400 per cent the proportion of the heat useful for boiling water.

Now, going one step farther, if the heat in a stream of gas is to be utilized thoroughly, i. e., recovered by transferring it to water, first in heating and second in boiling that water, then the initial temperature of the gas should be such that the quantity of heat which the gas gives up in cooling to 100° should bear to that which it gives up in cooling from 100° down, at least as large a proportion as that which the work of boiling bears to the work to be done in raising the water to the boiling point, in short, a proportion at least as great as 5.36:1. And, because (always neglecting variations in specific heat) the heat given out in cooling is proportional to the range of temperature which that cooling covers, it follows that the margin between the initial temperature and 100° should be to 100° , at least in this ratio of 5.36 to 1; or in short that the initial temperature should be at least $100^{\circ} + 536^{\circ} = 636^{\circ}$. If it is lower than this, then in order to contain enough heat in excess of the boiling temperature, the quantity of gas must be so great that its residual heat, when it has cooled to 100° , is more than the water can utilize and recover, in being heated up to 100° ; and this excess of heat must therefore remain in the gas and be lost.

To state it more generally, if we let

t_c = the critical temperature;

t_1 = the initial temperature of the gas, usually its combustion temperature;

h_c = the heat which must be supplied at and above the critical temperature; and

h_b = the heat needed in bringing the body to be heated up to that temperature; then for economy the initial or combustion temperature should be as high or higher than that which the following formula calls for, $(t_1 - t_c) : t_c = h_c : h_b$, whence

$$(35) t_1 = t_c \left(1 + \frac{h_c}{h_b} \right)$$

To sum up, continuous heating operations which derive their

heat from passing gaseous products of combustion or other hot gases, may be divided into those which have and those which lack a critical temperature, at and above which more heat is needed because of some heat-absorbing reaction, change of state, or the like, than at the average of the temperatures below it; and these two classes differ in the following important respect as regards the initial or combustion temperature which those heating gases must have in order that their heat may be well utilized. If there is no critical temperature, then it suffices that there shall be some margin between that initial temperature and the temperature to which the objects are to be heated, and the breadth of that margin is of secondary importance; if there is a critical temperature, then that margin must be at least as great as (35) requires.

Most of our metallurgical operations have a critical temperature, or more than one. In our fusion processes it is in general the melting point of the metal treated; in the iron foundry it is the melting point of cast iron, and the critical work is supplying the latent heat of fusion of that cast iron; in the calcination of limestone it is the dissociation point of calcium carbonate, and the critical work consists in supplying the heat absorbed by that dissociation.

Simple heating processes, on the other hand, in general have no critical point. In heating copper bars in a continuous furnace like Morgan's, Fig. 113. p. 377, there is no critical temperature. In heating steel billets in such a furnace, or steel ingots in a regenerative gas furnace, there is none, unless we choose to go to the extreme refinement of considering the slight excess of heat which heating the steel through its critical range A_{cr} to A_{c3} requires.

341 A. EQUATION 35 TESTED. — Let us test our law by applying it to three cases, of which the first has the initial gas temperature for which the law calls, while the second has a lower, and the third a higher initial gas temperature.

<i>Case 1st. Distribution of heat supplied by gas initially at 636°, in heating and boiling water.</i>	
To heat 1 gramme of water from 0° to the boiling point 100°, needs $1 \times 1 \times 100 = \dots\dots\dots$	100 calories
The latent heat of evaporation of 1 gramme of water already at the boiling point is $\dots\dots\dots$	536 calories
Total heat of evaporation $\dots\dots\dots$	<u>636 calories</u>

Applying these numbers to equation (35), the combustion temperature t_1 , which the boiler fire should give to the gases resulting from that combustion, should be at least

$$t_1 = 100 \left(1 + \frac{536}{100} \right) = 636^\circ.$$

Now let us see how this heat may be used in the work of heating and boiling water.

In cooling from 636° to 100° , 50 grammes of gases, with a specific heat assumed for simplicity at 0.25, give out

$$(636 - 100) \times 50 \times 0.25 = 6,700 \text{ calories.}$$

If all this heat is taken up by the work of boiling the water already in the boiler and at 100° , it can boil

$$6,700 \div 536 = 12.5 \text{ grammes of water.}$$

There will remain in the gas, now at 100° ,

$$100 \times 50 \times 0.25 = 1,250 \text{ calories,}$$

and if, on its way from the boiler towards the chimney, this passes through a series of feed water heaters which offer no frictional resistance to the transfer of heat from gas to feed water, the whole of this 1,250 calories might theoretically thus be transferred and so utilized in heating that feed water up to 100° . How many grammes could it thus heat? Clearly 1,250 divided by the heat needed to raise 1 gramme from 0° to 100° , or

$$1,250 \div (1 \times 100) = 12.5 \text{ grammes,}$$

or at the rate of 4 grammes of gas per gramme of water.

In short, the heat left in the gas after it has done its critical work of boiling 12.5 grammes of water can theoretically be fully consumed and therefore utilized in preheating up to the critical temperature a corresponding 12.5 grammes; so that the operation can go on continuously with perfect utilizing of the heat, and the escaping gases, in giving up all their heat, would be cooled to 0° .

Case 2nd. *Distribution of heat supplied by gas initially at 318° , in heating and boiling water.* Total heat in 50 grammes of gas,

$$50 \times 318 \times 0.25 = 3,975 \text{ calories.}$$

In cooling from 318° to 100° , 50 grammes of gas give out

$$(318 - 100) \times 50 \times 0.25 = 2,725 \text{ calories.}$$

This can evaporate

$$2,725 \div 536 = 5.1 \text{ grammes of water,}$$

or at the rate of 9.8 grammes of gas per gramme of water.

There will still be left in the gas

$$100 \times 50 \times 0.25 = 1,250 \text{ calories.}$$

Of this none can be used in boiling any more water, because gas at 100° can give no heat to water already at 100° ; therefore the only use to which this heat can be put is to heat up towards the boiling point another lot of 5.1 grammes of water, to replace those which have just been boiled away. But this water, in thus heating, can absorb from the gases only

$$100 \times 5.1 \times 0.25 = 127.5 \text{ calories,}$$

or only about 10 per cent of the 1,250 calories left after the gas has done all the work of which it is capable in the boiling of water. The remaining, $1,250 - 127.5 = 1,122.5$ calories, because they cannot be removed from the escaping gases by the operation of heating water, must remain in them and be lost, unless perchance they can be utilized for some other purpose.

On comparing this result with that of case 1st, we see that lowering the initial temperature of the heating gases by 50 per cent, from 636° to 318° , has forced us to waste $1,122.5 \times 100 \div 3,975 = 28$ per cent of the heat initially present in the gas, instead of recovering the whole of it.

Applying the temperature equation,

$$(36) t = \frac{H}{W \times S.H.}$$

in which H is the number of calories in the gases, W their weight in grammes, and S.H. their specific heat, the final temperature of the gases as they escape from the feed water heaters would theoretically be

$$t = \frac{1,122.5}{50 \times 0.25} = 89.8^\circ.$$

Case 3rd. *Distribution of heat supplied by gas initially at 1272° , in heating and boiling water.* Here it is even easier than in case 1st to utilize the whole of the heat, because here, of the

total heat present, the proportion available for boiling, instead of being barely enough to do the heating work which must be done above 100° , is much greater, and this surplus can be applied either to boiling or to heating towards 100° .

In cooling from $1,272^{\circ}$ to 0° , 50 grammes of gas give out

$$1,272 \times 50 \times 0.25 = 15,900 \text{ calories.}$$

This heat is capable of heating and boiling

$$15,900 \div 636 = 25 \text{ grammes of water.}$$

The heat absorbed in boiling this water, as distinguished from heating it towards 100° , is

$$25 \times 536 = 13,400 \text{ calories,}$$

in supplying which our 50 grammes of gas would cool through

$$13,400 \div (50 \times 0.25) = 1,072^{\circ},$$

so that their temperature would sink from $1,272^{\circ}$ to 200° .

In order now, to recover the heat still remaining in these gases it suffices that the work remaining for them to do, *viz.*, heating to the boiling point a new lot of 25 grammes of water to replace that which they have just boiled away, should be capable of absorbing the heat which they still retain, or

$$200 \times 50 \times 0.25 = 2,500 \text{ calories.}$$

And this is just what the work remaining for them implies: for to heat this 25 grammes from 0° to 100° requires just

$$25 \times 100 \times 1 = 2,500 \text{ calories,}$$

or at the rate of 2 grammes of gas per gramme of water.

Thus, if matters are so arranged that, as soon as the gases have cooled to 200° , they sweep away from the boiler proper to the series of feed-water heaters with walls made of some substance which conducts heat perfectly, the heat left in them after they have done their work above the boiling or critical temperature can just be absorbed and utilized in heating up to that critical temperature another lot of water, just replacing that which they have boiled away, and the utilizing of the heat is perfect.

The student need hardly be told that such adjustment is impossible in practice, and that perfect conductors of heat, like

perfectly adiabatic materials, and indeed like the philosopher's stone, exist only in our imagination. Yet these ideas help to explain the limits which we work towards but can never reach.

Recapitulating these three cases,

If the combustion temperature is	the percentage of heat utilized is	the final temperature of the gases is	and for each gramme of water we need
636°	100	0°	4
318°	72	89.8°	9.8
1272°	100	0°	2

} grammes of gas

To sum up, the law satisfies these tests, for when (Case 1st) the initial temperature is that which the law calls for, and when (Case 3d) it is still higher, the recovery of the heat of the heating gases is complete; but when (Case 2d) it is only half what the law calls for, only 72 per cent of that heat can be recovered even theoretically.

341 B. IMPORTANCE OF THE CRITICAL TEMPERATURE IN THE BLAST-FURNACE PROCESS. — In this process there are at least two important critical temperatures, and probably more; and the critical heat, *i. e.*, the quantity of heat which must be supplied above those temperatures, is probably very large. The melting points of iron and slag, respectively, are two critical temperatures as to the existence of which there can be no question; and the quantity of heat absorbed in melting the iron and slag, respectively, their latent heat of fusion, may well be very large. Further, the de-oxidation of silicon by reaction (15) $\text{SiO}_2 + 2\text{C} = \text{Si} + 2\text{CO}$ (p. 394) and the removal of sulphur, whether by reaction (30) $\text{FeS} + \text{CaO} + \text{C} = \text{Fe} + \text{CaS} + \text{CO}$ (p. 395) or by other means, very probably call for still higher temperatures and for much heat.

Let us now go on to consider the first of the reasons given in § 339 for the fuel economy of the Gayley process, *viz.*, that drying the blast greatly widens the margin between the combustion temperature and the critical temperature, and thus increases by a correspondingly large fraction the proportion of the heat developed which is available for the critical work, quite as raising from 101° to 105°, or by only four per cent, the initial temperature of the gases which are to boil water, increases the heat theoretically available for the critical work of boiling by some 400 per cent.

A complete analysis of these critical temperatures and of the heat required for each would carry us beyond the limits of

the present work; but it may be instructive to assume for purposes of illustration a critical temperature of $1,300^{\circ}$,* between the melting point of the iron and that of the slag, and adopting Professor J. W. Richards† estimates of the combustion temperature (*i. e.*, the initial temperature of the gases after their combustion in the hearth, before any of their heat has been given up to the surrounding solid and molten materials), as $1,965^{\circ}$ for dried blast and $1,861^{\circ}$ for moist blast, to see what effect ought to be caused by changing from dried to moist blast.

When the combustion temperature is $1,965^{\circ}$, the margin between it and the critical temperature is 665° ; but this margin is only 84 per cent as great, or 561° , when the combustion temperature is $1,861^{\circ}$. But with this lower combustion temperature and this narrower margin, just as much heat must be supplied above the critical temperature to do the critical work as when the combustion temperature was higher. But how can this be brought about? Either by restoring the combustion temperature to its old level and thus getting the old greater margin between combustion temperature and critical temperature, or by burning more fuel.

The combustion temperature could be restored to its old level by any one of several expedients, such as raising the temperature of the blast, and so directly raising the temperature

* The critical work of melting the slag must indeed be carried out at the melting point of that slag, which is much above $1,300^{\circ}$; but if we were to confine our attention to this higher temperature we should seem unfair, because we should neglect the fact that, of the heat left in the gases after supplying the heat absorbed by the melting of the slag, much could still be used, not only in the uncritical work of heating the solid materials up to this temperature, but in the critical work of melting the iron at its lower melting point of, say, $1,200^{\circ}$. If on the other hand, we confined our attention to this lower critical point, we should manifestly understate the case, by making no provision for the critical work of melting the slag. The critical temperature of $1,300^{\circ}$ to which we shall confine our attention, then, is to a certain degree *pro forma*. My aim is, not to show accurately just how great the saving due to drying the blast should be, but rather to show that, on any reasonable assumption, this saving ought to be very great, far out of proportion to the heat directly needed for heating and dissociating the moisture.

† "The Application of Dry-Air Blast to the Manufacture of Iron," to appear probably in Vol. XXXVI, *Trans. American Inst. of Mining Engineers*.

level from which combustion starts; or by lessening the quantity of nitrogen in the blast, and so diminishing the denominator of the right-hand side of the temperature equation,

$$(36) t = \frac{H}{W \times S.H.} :$$

or by using a fuel of greater pyrometric intensity, which may either increase the numerator or lessen the denominator of that side. Of course the combustion temperature is not affected by increasing the quantity of fuel, which simply increases in like proportion the numerator and denominator of this side of the equation.

But to get by means of extra fuel as much heat available above the critical temperature with moist blast, when the margin is only 561° , as when it is 665° , means burning $665 \div 561$ or 1.19 times as much fuel per ton of iron, or 19 per cent more fuel, than with dried blast. That this number happens to agree with the actual saving, which Mr. Gayley effects, is of course no indication that my estimates are accurate. The agreement is wholly accidental; indeed, I could easily have framed those estimates so as to bring about such an apparent agreement.

But is as much as 19 per cent of extra fuel really needed? To simplify our discussion, let us divide the heat generated, whether by the extra fuel or what we may call the regular fuel (that is to say, the quantity of fuel which would be needed even with dried blast), into the heat represented by the margin between the combustion temperature and $1,300^{\circ}$, and that represented by the margin between $1,300^{\circ}$ and 0° ; or, in short, into the heat above $1,300^{\circ}$ and the heat below $1,300^{\circ}$. The gases from our extra fuel, which supplies the extra heat needed above $1,300^{\circ}$, must, when they have cooled from $1,861^{\circ}$ to $1,300^{\circ}$, a distance of 561° , still contain $1,300 \div 561 = 2.3$ times as much heat as they have given out above $1,300^{\circ}$.

Now, will not some of this extra heat below $1,300^{\circ}$ be recovered by the descending solids in the upper part of the furnace as the rising gases sweep past them? And will not the extra carbon monoxide generated by burning the extra fuel at the tuyères be in part oxidized to carbon dioxide in the upper part of the furnace, there doing useful work and generating usable heat?

Apparently not. Three aspects of the case may be considered. First, is any of the extra carbon monoxide later oxidized to carbon dioxide, and if so, is any useful work thus done? Second, of the heat above $1,300^{\circ}$, from the extra fuel, is a larger proportion available for the critical work above $1,300^{\circ}$? Third, of the extra heat below $1,300^{\circ}$, can any part be recovered and put to useful work?

To the first question the answer is probably "No." It is true that, as the gases pass upwards through the furnace, a great quantity of their carbon monoxide is oxidized to carbon dioxide by the oxygen of the ore; but this quantity is fixed per ton of iron. A ton of ore contains only just so much oxygen, with which it can oxidize only just so much carbon monoxide; and increasing the quantity of carbon burnt and carbon monoxide generated in the hearth per ton of iron made, which is the same as saying per ton of ore charged, does not add one atom to the oxygen in that ore, or to the quantity of carbon monoxide which that oxygen can oxidize to carbon dioxide. Thus nothing more is to be got out of the descending column of solids in the way of further oxidation of carbon monoxide to carbon dioxide.

Passing now to the second question, of the heat above $1,300^{\circ}$ only a part will actually be used for the critical work above $1,300^{\circ}$, because that work has to be done in a very limited part of the furnace, just in the region of highest temperature. Through this region the very expanded gases rush at very great speed, so that they leave it before giving up all of their heat which is above $1,300^{\circ}$, just as the gases of a boiler fire must necessarily sweep past the boiler to the feed-water heaters, before they have given up to the boiler all of their heat above the boiling point. Now, the present question is this: of the heat above $1,300^{\circ}$, is a larger or a smaller proportion actually used for the critical work above $1,300^{\circ}$, in case of moist blast, than in case of dried blast? If a larger proportion, then this would make for lessening the extra fuel really needed to something below the 19 per cent apparently needed; if a smaller proportion, this would make for increasing the extra fuel needed.

The proportion must be smaller in case of moist blast for two evident reasons. First, the transfer of heat from the gases to the solid and molten bodies which they are heating (the temperature of which is assumed to be the same in both cases) is

slower, because the combustion temperature in case of moist blast is much lower than in case of dried blast, and because, the less the difference in temperature between any two bodies, the more slowly will heat pass from one to the other. Second, the time available for this heat transfer is much shorter in case of moist blast, because of the greater quantity of gases resulting from the greater weight of fuel which must be burnt, and their consequent more rapid passage through the hearth. This greater weight of gases outweighs, in its influence on their volume, their initial lower temperature.

Passing now to the third question, we at once meet the fact that, even with dried blast, the gases escape hot from the top of the furnace, which means that the descending solids are unable to absorb and recover even the smaller quantity of heat in the smaller volume of more slowly moving gases formed with dried blast. If they cannot absorb and recover the whole of this smaller quantity of heat, how are they to absorb any of the extra heat in the larger volume of gases generated with moist blast, especially in view of their traveling faster because there is so much more of them, and thus having less opportunity for heat transference? The only extra heat-absorbing capacity which the descending solids now have is that caused by their containing the extra 19 per cent of coke, which will have to be burnt at the hearth to compensate for the narrowed margin between combustion temperature and critical temperature. It is only in virtue of their containing this extra 19 per cent of coke that the descending solids have any extra heat-absorbing power; and they can absorb extra heat solely for heating up the extra coke which is the source of the extra quantity of gas, and is in weight only a small fraction of the weight of those extra gases the heat of which this coke is to absorb. But this cannot be regarded as contributing to the useful work of the furnace, which consists in deoxidizing iron ore, silica, and lime, dissociating limestone, and melting and superheating the iron and slag. All that can be said is that part of the heat developed by the extra fuel can be utilized in heating that fuel itself. But of the extra heat present in the products of its combustion after they have cooled to the critical temperature, none appears to be available for the useful work of the process.

In short, the fact that, even with dried blast, the gases still

escape hot from the top of the furnace, leaves us without strong reason to think that with moist blast the descending solids can recover for any of the useful work of the furnace any of the extra heat below $1,300^{\circ}$ due to the extra fuel.

Thus we find no escape from the conclusion that the large excess of coke apparently needed in the hearth, in case of moist blast, is actually needed; that of all the heat which its combustion develops, only that represented by the narrowed margin between combustion temperature and critical temperature can be utilized, with the exception of that used in heating the coke itself to the critical temperature, so that the rest of this heat is wasted.

How great is the contrast between the small usefulness of this extra fuel and the very great usefulness of the fuel used with dried blast! Most of the heat which this latter fuel develops is well utilized in the useful work of deoxidizing, pre-heating, dissociating, melting, and superheating.

What has been said of the extra heat developed by the extra fuel needed to make good the narrowing of the temperature margin, is equally true of the extra heat needed to make good the heat absorption in the dissociation of the moisture.

This reasoning, then, seems to make good the first three reasons given in the beginning of § 339.

If our judgment, which looks always to find some great cause for a great effect, revolts at the idea that taking a little moisture out of the blast should save 19 per cent of the fuel in the blast-furnace, consider again the cases given in § 340; consider especially that raising the combustion temperature from 101° to 105° , or by only four per cent, theoretically increases the proportion of heat available above the critical temperature of the boiling of water by 400 per cent. Consider a stream of water four feet deep, the upper surface of which is one inch above the level of the waste weir; raise the upper surface of the stream by ten per cent, or 4.8 inches, and the flow over the waste weir increases 480 per cent. Consider the swimmer whose entangled feet let him stretch his mouth to within an inch of the surface; he might as well be a mile below. His last inch, if he can gain it, is worth infinitely more than the ten fathoms he has already risen.

The reason why the relation of the initial or combustion temperature to the critical temperature has not hitherto received

due attention, is probably that in most of our familiar operations the margin between the two is so great that the usual variations in that margin are not of very great importance. So far as I have noticed, Mr. J. E. Johnson, Jr.,* was the first to point out clearly the importance of the critical temperature in the blast-furnace process.

The reasons which have now been given to explain why drying the blast causes a saving of fuel greatly out of proportion to the quantity of heat which the heating and dissociation of the moisture directly need, and why it lowers the temperature of the escaping gases, apply with equal force to explain why the saving which Neilson's invention of the hot blast effected, and every saving later made by further heating the blast, were so greatly out of proportion to the quantity of heat thus given to the blast, and why heating the blast was immediately followed by a drop in the temperature of the escaping gases and a rise in the ratio of carbon dioxide to carbon monoxide.

These reasons may be recapitulated as follows:

Adding moisture to the blast not only calls for extra fuel to supply the extra heat needed for heating and dissociating this moisture, but (like cooling the blast or diluting it with additional nitrogen) by lowering the temperature which combustion develops, narrows the already narrow margin between that temperature and the critical temperature, above which a very much larger quantity of heat is needed, to make good the absorption

*"Notes on the Physical Action of the Blast-Furnace," *Trans. American Inst. Mining Engineers*, to appear probably in Vol. XXXVI.

Mr. Johnson called my attention to the importance of this subject some years before the disclosure, but not before the invention, of the Gayley process. In this present discussion I have tried to give some needed additional precision to Mr. Johnson's definition of the critical temperature. He defined it simply as one above which certain necessary operations must be carried out. Thus defined this term applies equally to what I have called non-critical processes. His reasoning about the importance of the critical temperature is not valid, unless this is further defined as, in addition, one at or above which the heat requirement is greater, because of some special heat absorption, than at the average of the temperatures below it, a condition which he probably had in mind.

Further, I have carried the reasoning a step farther, by showing why it is that, of the heat developed by the extra fuel, probably only that which is represented by the narrowed margin between the combustion and the critical temperature can be utilized.

due to the latent heat of fusion of iron and slag, and probably of deoxidizing silica and lime, than is needed at the average of lower temperatures. The combustion temperature was in this special case further lowered and this margin thereby further narrowed, by a decided lowering of the blast temperature due to the fact that, with the hot blast stoves used, the larger quantity of blast needed could not be heated so hot, although the gas used for heating it seems to have increased in quantity proportionally, and to have improved in quality. (This part of the narrowing of the temperature margin might perhaps be made good by enlarging the hot blast stoves.)

If the narrowing of this margin is to be made good by burning more fuel, then of the heat generated by that fuel only that corresponding to the narrowed margin between the combustion and the critical temperatures can be utilized. Of that represented by the range of temperature below this we see no strong reason to expect that any important part can be recovered from the products of the combustion of this extra fuel by the descending solids, nor can the carbon monoxide generated by this extra fuel be converted into carbon dioxide by those solids, because, even with hot and dried blast, the power of those solids to absorb heat and to oxidize carbon monoxide appears to be already fully utilized, so that we have no strong reason to think that they can do more in either respect. This extra quantity of carbon monoxide and this extra heat may therefore be expected to be present in the gases when they escape from the top of the furnace, and these gases should therefore both be hotter and have a lower ratio of CO_2 :CO. Indeed, the quantity of carbon monoxide in the escaping gases should be even greater than this would imply, because, being hotter, their carbon dioxide should react the more energetically upon the entering coke, and thereby be reduced to carbon monoxide, and further increase the fuel consumption by thus dissolving away part of the entering coke, which must be replaced by more extra fuel.

Indeed, the matter is still worse. Narrowing the margin between the combustion and the critical temperatures lessens the thoroughness with which even the heat represented by the narrowed margin can be utilized even for the critical work, first, because the cooler gases transfer their heat to the solid and molten matter which they have to heat less rapidly because of the nar-

rowed temperature margin between them, and next because, thanks to their greater weight and hence volume, they pass more rapidly by that matter. The heat transfer is slower, and the time allowed for the transfer is shorter.

Like advantages are to be expected from any further step which will widen the margin between the combustion and the critical temperatures, such as heating the blast still hotter or removing part of its nitrogen.

342. NOTE ON SORBITE AND THE OTHER STAGES OF TRANSITION BETWEEN AUSTENITE AND PEARLITE.

The greater hardness of martensite than of austenite in hyper-eutectoid steel, though it may well be due to the presence of beta iron in the martensite, can also be explained mechanically, because a first step in this transformation is that, within the austenite, cementite, which is much harder than austenite, forms. The facts (1) that martensite habitually forms along the cleavage planes of the austenite, and apparently preserves the latter's acicular structure, (2) that troostite habitually is sharply divided from martensite, and (3) that troostite, sorbite, and pearlite shade off without break into each other, are explicable by either theory, though the second suggests an essential difference, and the third a quantitative one.

Sorbite can be generated in many ways which permit the transformation to go far but not to complete itself, for instance, by quenching in oil, which cools the steel so slowly that the transformation can go beyond the martensite stage of water-quenched steel, but not slowly enough to enable it to reach the pearlite stage of slowly cooled steel; or by quenching in water after allowing the transformation to complete itself in part by cooling slowly through a part of the critical range, region V and VII; or by carrying the reheating or "tempering" of water-hardened steel nearly to A_1 .



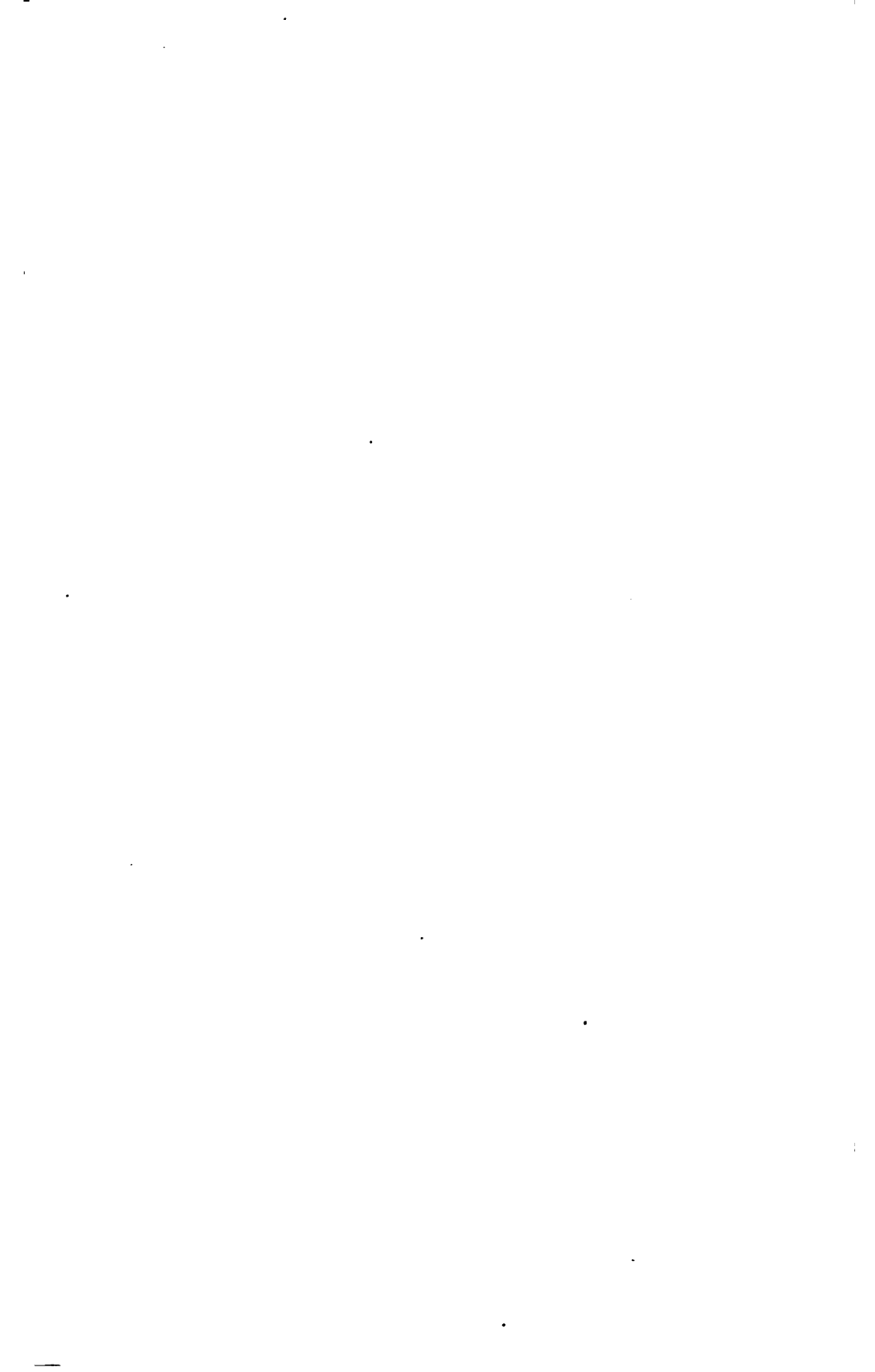

INDEX

A

	PAGE
Adjusting processes of iron manufacture	330
Allotropic changes of state in solids	225 to 228
modifications are phases: the phase rule	297
states in the iron-carbon compounds	214 to 216
of sulphur	225 to 227
Alloy, microstructure of a bismuth-tin	32
copper-aluminium	48, 88
silver-copper	46 to 49
tin-antimony	46, 89
steels	165, 316 to 325
Alloys, constitution of non-eutectiferous	64 to 71
containing definite chemical compounds, series of	148 to 152
, cooling curves of	17 to 52
, electric conductivity of lead-tin	156
silver-copper	157
silver-gold	155
, electromotive force of lead-tin	159
, eutectic of copper-antimony	33
, eutectiferous range of binary	62 to 64
, freezing-point curve of copper-antimony	150
gold-aluminium	150
lead-tin	54, 55, 60, 61
, lead-tin	43, 52 to 57
, methods of study of the constitution of	13
, microscopic examination of	14
of limited reciprocal solubility type	68 to 75
the solid solution type	64 to 68
, on the eutectic structure of copper-silver	41
, possible components of	2 -
, series of copper-antimony	148
gold-aluminium	149
, their resemblance to the crystalline rocks	3
Alpha iron	215
, influence on magnetic properties	447, 448
Aluminium-copper alloy, microstructure of an	48, 88

	PAGE
Aluminium-gold alloys, the series of	149
Ammonium sulphate, its recovery in the Mond gas process	453 to 457
Annealing of chilled castings, the	280
steel	231
Antimony-copper alloys, eutectic of	33
, series of	148
-tin alloys, microstructure of	46, 89
Attack-polishing method of preparing metallic sections	17
Austenite	177 to 179, 475
: hardened steel	164
, laws concerning the structure of	246 to 248
, purity of	193
series of iron-carbon compounds	191, 192
Autographic arrangement for recording thermal curves	153
Automorphic crystal, definition of	51

B

Basic Bessemer iron, composition of	327, 363
process	362 to 364
slag, composition of	364
steel, composition of	327
open-hearth process	349, 356
Bedson continuous rolling mill	378
Belgian continuous rolling mill	379
Bertrand-Thiel process, the	355
Bessemer process, the	356 to 364
Beta iron	216, 475
, influence on magnetic properties	447, 448
Bismuth-tin alloy, microstructure of a	32
alloy, freezing-point curve of	75
Blast-furnace, the	384 to 407
arrangement at Duquesne, the	333
, chief functions of the	388
, conditions within the	384 to 386
, control of the hearth temperature in the	398 to 401
, deoxidation in the	392 to 396
, functions of the fuel in the	391
gas-engines	337
, Gayley dry-blast process in the	457 to 475
, hearth temperature of the	406
, increase in the rate of production in the	342
, metallurgical management of the	392
process, the	330 to 343
, importance of the critical temperature in	467 to 475
, reactions in the	387, 391 to 395, 405
, section of a Duquesne	334

Index

479

PAGE

Blast-furnace slag, effect of deoxidation on the lime-content of	405
, regulation of the melting-point of	402
slags, composition of certain	403
stoves, hot	338 to 342
Blowholes	368 to 372
Boundary between steel and iron	447
Boynton on troostite	180
Brinell on blowholes	369 to 372
Brittleness caused by overheating and its cure	259
, Stead's	255
Burning	257 to 262
Burnt steel, microstructure of	258

C

Calculations, stoichiometric	182, 183
Campbell, H. H., on classification and definitions of iron and steel	440
Campbell's tilting furnace	352, 353
Carbide-carbon	176
Carbon condition, influence of quenching temperature on	224
in iron, conditions of	172
monoxide, its oxidation in the blast-furnace process	470
Carburizing processes, the Harvey and Krupp	325
Car-casting system, the	358 to 361
Castings, the annealing of chilled	280
, the manufacture of malleable	281
Cast iron, definition of	442, 443
, genesis of white and gray	435 to 437
, gray, constitution of	163, 168, 431 to 435
, microstructure of	48, 92, 432
, mottled	168
of 4% carbon, its constitution and properties	437 to 440
, the chilling of	279
, the handling of molten	332
, the heat-treatment of	276 to 282
, white, constitution of	163, 184
, white, physical properties of	162
irons, reactions in freezing and cooling of typical	277 to 279
Cement-carbon	176
Cementite	160, 175
Charging system, the Wellman	354
Chemical compounds among metals	8
Chilled castings, the annealing of	280
Chilling of cast iron, the	279
Chrome steel	323

	PAGE
Classification of iron and steel by carbon-content	186, 187
, general	166, 167
; names and apparatus in which generally made	440, 441
processes of iron manufacture	329
Comparison of gas-firing and direct-firing furnaces	411 to 416
regenerative and recuperative furnaces	416, 417
steel processes	365
the acid and basic Bessemer processes	363, 365
the acid and basic open-hearth processes	349, 365
Components and phases: the phase rule	294 to 297
Composition of basic Bessemer iron	327, 363
slag	364
steel	327
iron blast-furnace slags	403
self-hardening steels, limits of	324
Taylor-White steel	324
typical kinds of steel	172
-temperature curves	135 to 147
Compounds, chemical, among metals	8
Compression, fluid, of steel ingots	373
Conditions of equilibrium	75 to 83, 285 to 288
Conductivity, electric	152, 153
Continuous heating furnace, Morgan's	377, 378
rolling-mill	378
Constitution of alloys, methods of study of the	13
binary alloys forming no chemical compound	59 to 148
cast iron of 4% carbon	437 to 440
gray cast iron	163, 168, 431 to 435
hardened steel	164
iron and steel, microscopic	186, 187
the eutectic	84
iron-carbon compounds	184, 185
non-eutectiferous alloys	64 to 71
pearlite series, theoretical	184, 185
white cast iron	163
wrought iron	164, 168 to 170
Consumption of iron, per capita	382
Conversion or purifying processes of iron manufacture	330
Converter linings, life of	364
Converters, maximum production by a pair of American	361
, range in size of	361
Cooling curve, its correspondence with the temperature-composition curve	145
of a solid solution alloy	68, 71
alloys of limited reciprocal solubility	70, 71
high-carbon steel	220

	PAGE
Cooling curve of tin	35
curves	17 to 52
, distortions of	20
, inflections in	19
: jog	28
, malobservation in recording	20
of lead-tin alloys	60
salt-water	18, 29, 30
the iron-carbon compounds: deformations by lag	218
, their relation to freezing-point curves	52 to 61
, thermo-electric method of recording	22
Copper-aluminium alloy, microstructure of a	48, 88
-antimony alloys, eutectic of	33
, the series of	148
-silver alloys, electric conductivity of	157
, microstructure of	46 to 49
, on the structure of the eutectic of	41
-tin alloy, microstructure of a	72
Cost of iron and steel manufacture	380, 381
Cowper hot-blast stove	341, 342
Critical curves (see saturation-point curves)	
temperature in heating processes, its importance	460 to 475
the blast-furnace process, its import- ance	467 to 475
of a heating process defined	460
temperatures of iron and steel	20, 194, 214 to 217
Cryohydrate	31
Curves, cooling	17 to 52
, freezing-point	52 to 61

D

Darby's recarburizing process	364
Definition of "critical" temperature in a heating process	460
Definitions of the iron-carbon compounds, scheme of	170, 171, 442 to 447
Degree of liberty: the phase rule	299
Density, stratification according to	44, 45
Deoxidation in the blast-furnace	392 to 396
Diffusion	100 to 102, 113
Direct-firing, advantages of gas-firing over	411 to 416
furnaces	407
metal, the use of	357
Distortions of cooling curves	26
"Draft" fluid compression of steel ingots	373
Dry-blast process, Gayley	457 to 475
Ductility of manganese steels	320, 322

	PAGE
Ductility of nickel steels	319
steel, influence of T^{\max} on the	272 to 274
Duff gas producer, the	428, 429
Duquesne blast-furnace arrangement	333
, section of a	334

E

Elastic limit of steel, influence of T^{\max} on the	269 to 272
manganese steels	323
Electric conductivity	152 to 159
Electromotive force	159
of the lead-tin alloys	159
Elongation of manganese steels	321, 322
nickel steels	319
steel, influence of T^{\max} on the	272 to 274
Engines, blast-furnace gas	337
Equilibrium, meaning and conditions of	75 to 83, 285 to 288
Eutectic	28, 31
, constitution of the	84
-freezing period	40, 41
, Guthrie on	31
, influence of the structure of the	43
of alloys of limited reciprocal solubility	72 to 75
copper-antimony alloys	33
copper-silver alloys	41
phosphoric iron	33
solid solution alloys	66, 67
the iron-carbon compounds	182, 204
, properties of the	31 to 35
, reasons for the properties of the	33 to 35, 38 to 43
salt solution, freezing of	30
, structure of the	32, 41 to 43
Eutectiferous range	113
of binary alloys	62 to 64
Eutectoid, the	176, 177
steel, heat-refining of	251
Examples testing the phase rule	300 to 311
Excess-freezing period, the	40, 41
"Excess-substance," meaning of the term	40
Extraction of iron from its ores	330 to 343

F

Ferrite	160, 175
Finishing temperature, its influence on the grain-size	263 to 267
microstructure of steel	265
Forging hammers, steam	379

	PAGE
Forging presses, hydraulic	379
Fracture and temperature, general laws concerning	245 to 252, 264
, its relation to structure	244
of barked wrought iron	243
iron and steel, the	243 to 267
Freezing, its effect on segregation	102 to 113
of eutectic salt solution	30
hyper-eutectic salt solution	30
hypo-eutectic salt solution	29
the iron-carbon compounds, reactions in	197 to 203
range	26
, selective	24, 26, 28, 65, 66, 135, 139 to 147
, the landlocking type of	93 to 99
, the onion type of	85, 88
, types of	28, 85 to 99
, unselective	28
Freezing-point curve, its relation to the saturation-point curve	119 to 133
of alloys of limited reciprocal solubility	74, 75
bismuth-tin alloys	75
copper-antimony alloys	150
gold-aluminium alloys	150
lead-tin alloys	54, 55, 60, 61
mercuric bromide and iodide	118
salt-water	58
silver-gold alloys	67
the iron-carbon compounds	193 to 208
curves	52 to 61
, effect of surfusion on	36
Fuel, its functions in the blast-furnace	391
, reasons for economy in the Gayley dry-blast process	458, 459
Furnace, direct-fired reverberatory puddling	140
, the Roe puddling	449 to 453
, the Siemens	350 to 353
, tilting	352 to 354
walls, preservation of the	336
Furnaces, advantages of gas-firing over direct-firing	411 to 416
, comparison of regenerative and recuperative	416, 417
, direct-firing	407
, gas	407 to 430
, gas-firing	408
, heating	375 to 378
, regenerative, the rise of temperature in	422

G

Gamma iron	216
in austenite	178
, influence on magnetic properties	447, 448

	PAGE
Gas engines, blast-furnace	337
-firing, its advantages over direct-firing	411 to 416
-furnaces	407 to 430
producer, the Duff	428, 429
, the Mond	453 to 457
, the Siemens	423 to 425
, the Taylor	425 to 428
, the use of steam in the	429
regeneration, the value of	418 to 422
used in metallurgy, kinds of	408
Gasification for gas-firing, the purpose of	409
Gayley dry-blast process	457 to 475
; reasons for the fuel saving	458, 459
Gayley's water-cooling blocks	336, 337
Gjers soaking pit	375, 376
Gold-aluminium alloys, freezing-point curve of	150
, the series of	149
Gold-silver alloys, electric conductivity of	155
, freezing-point curve of	67
Grain-size and temperature, relation between	246 to 257, 262 to 267
, influence of the finishing temperature on the	263 to 267
of eutectoid steel, the	246, 247
steel, influence of T_{max} on the	248 to 251
, laws concerning the	246 to 252, 264
Graphite as a component of gray cast iron	181
: gray cast iron	163
in cast iron	208 to 211, 397
in cast iron, effect of conditions in the blast-furnace	397
on the quantity of	282
, temper	188, 189
Graphite-pearlite series of the iron-carbon compounds	163, 168, 431 to 435
Gray cast iron, constitution of	435 to 437
, genesis of	164
, microstructure of	188, 189
series of the iron-carbon compounds	31
Guthrie on eutectic	

H

Hammers, steam	164
Hardened steel, constitution of	221 to 230
Hardening of steel, the	225
, influence of rapidity of quenching on the	235
power, its loss at the recalescence	178
Hardenite defined	325
Harvey carburizing process, the	398 to 402, 406
Hearth temperature in the blast-furnace, control of	

	PAGE
Heat, economic law (equation 35) of initial gas temperature in heating processes with a critical temperature	462
Heating furnaces	375 to 378
Heat, its utilization influenced by initial temperature	460 to 475
of solidification of lime-alumina silicates	403
-refining, brittleness from overheating cured by	259
of eutectoid steel	251
hypo-eutectoid steel	252 to 255
steel	242, 251 to 262
temperature	255
-tinting method of preparing sections for microscopic ex- amination	17
-treatment, its influence on the physical properties of carbon steel	267 to 276
its influence on the physical properties of nickel steel	318, 319
of cast iron, the	276 to 282
steel and cast iron	165, 217 to 282
utilization in the blast-furnace process	457 to 475
measured by temperature of escaping gases	460
Heterogeneous of solid solutions	13, 66, 88
Homogeneous of phases: the phase rule	297
Hot-blast, reason for its economy	473
stoves	338 to 342
Hydraulic presses	379
Hyper-eutectic salt solution, freezing of	30
Hypo-eutectic salt solution, freezing of	29
Hyper-eutectoid steel	176
Hypo-eutectoid steel	176
, heat-refining of	252 to 255

I

Idiomorphic crystal, definition of	51
Inflections in cooling curves	19
Ingots, defects in steel	366 to 373
, "draft" fluid compression of steel	373
, mechanical treatment of	366 to 380
, segregation in steel	372
Initial gas temperature, its importance in heating processes with a critical temperature	460 to 475
International Association for Testing Materials, classification and definitions of iron and steel prepared for it	440, 441
Iron, alpha	215
and steel, boundary between	447
, classification by carbon-content	186, 187

	PAGE
Iron and steel classification; names and apparatus in which	
generally made	440, 441
, definitions of the different varieties	442 to 447
, general classification of	166, 167
, heat-treatment of	165
, increase in production of	380 to 383
, magnetic properties of	447, 448
, manufacture, cost of	380, 381
, metallography of	160 to 217, 475
, microscopic constituents of	174 to 182, 475
, progress in the manufacture of	313 to 383
statistics . 313 to 315, 342 to 345, 347, 349, 361, 363, 366,	380 to 383
, structure of	242 to 267
, their prominent uses	186, 187
, basic Bessemer, composition of	327
, beta	216
Iron-carbon compounds, allotropic states in the	214 to 216
, constitution of the	184, 185
, freezing-point curves of	193 to 208
, graphito-pearlite series of	188, 189
, reactions in freezing and transforma-	
tion of the	197 to 203
, Roberts-Austen's diagram of the	192, 194
, scheme of definitions for the	170, 171, 442 to 447
, the austenite series of	191
, the pearlite series of	184, 188, 189
, transformation curves of the	193 to 214
, eutectic of phosphoric	33
, gamma	216
, its extraction from its ores	330 to 343
manufacture, the general scheme of	325 to 329
, wrought, manufacture of	343 to 347
Irreversibility	290, 291
Isomorphous mixtures (see solid solutions)	11

J

"Jog" of cooling curves, the	28
Johnson, J. E., Jr., on conditions within the blast-furnace	385
on critical temperature in the blast-furnace	
process	473
Jones's mixer	357

K

Kennedy hot-blast stove	340, 341
-Morrison rail-rolling process, the	266

Kourbatoff on the hardness of austenite and martensite	180
Krupp carburizing process, the	325

L

Lag	195, 289 to 292
, deformations of the cooling curves by	218
Laws concerning fracture and temperature, general	245 to 252, 264
Lead-tin alloys	43
, cooling curves of	60
, electric conductivity of	156
, electromotive force of	159
, freezing-point curve of	54, 55, 60, 61
Ledebur on carbide-carbon	176
temper-carbon	181
Lime-alumina silicates, heat of solidification of	403
Linings of converters, life of	364

M

Macroscopic segregation	101, 106
Magnetic properties of iron and steel	447, 448
Malleable castings, the manufacture of	281
Malobservation in recording cooling curves	20
Management of the blast-furnace, the metallurgical	392
Manganese, its influence on blowholes and pipes	370
retards the transformation of austenite	178
steel	317, 320 to 323
Manufacture of iron and steel, progress in the	313 to 383
, the cost of	380, 381
malleable castings, the	281
steel, the	347 to 366
wrought iron	343 to 347
Martensite	179, 180, 475
Materials, for the blast-furnace, the handling of raw	331
"Matrix," definition of the term	431, 432
Mechanical refining of steel	262 to 267
treatment of ingots	366 to 380
Metallography of iron and steel, the	160 to 217, 475
Metals, chemical compounds among	8
, microscopic examination of	14
, their resemblance to the crystalline rocks	3
Methods of treating sections for microscopic examination	16
study of the constitution of alloys	13
Microscopic constituents of iron and steel, the	174 to 182, 475
constitution of irons and steels	186, 187
the pearlite series	162
various steels	161, 162

	PAGE
Microscopic examination of alloys	14
segregation	101
Microstructure of a bismuth-tin alloy	32
austenite	180
a copper-aluminium alloy	48, 88
copper-tin alloy	72
alloys of limited reciprocal solubility	70
burnt steel	258
cast iron	92
copper-silver alloys	46 to 49
gray cast iron	164, 432
hypo-eutectoid steel	50
martensite	180
steel, effect of T_{\max} on the	250
(high-carbon)	180
, influence of finishing temperature on	265
quenching temperature on	224
the pearlite series	opp. 188
tin-antimony alloys	46, 89
white cast iron	48, 432
wrought iron	169
Mixed crystals (see solid solutions)	11
Mixer, the	357
Mixtures, Isomorphous (see solid solutions)	11
Molybdenum steel	325
Mond gas producer	453 to 457
Monell process, the	356
Morgan's continuous heating furnace	377, 378
Mother-liquor and mother-metal, definition of	19
Mottled cast iron	168
Mould car for the car-casting system	359

N

Neilson, his invention of the hot-blast	473
Nickel retards the transformation of austenite	178
steel	316 to 319
Nomenclature of the iron-carbon compounds	170, 171, 173, 442 to 447

O

Open-hearth process	347 to 356
, modification of the	354 to 356
Osmond on austenite	177, 178
the hardness of austenite and martensite	180
magnetic properties of iron	447

	PAGE
Process, pig and scrap	354
, puddling	344 to 347
, Siemens-Martin	347 to 356
, Talbot	355
Processes, comparison of steel	365
for compressing ingots for the prevention of pipes	373, 374
, Harvey and Krupp carburizing	325
of iron manufacture, classification of	329
Producer, the Duff gas	428, 429
, the Mond gas	453 to 457
, the Siemens gas	423 to 425
, the Taylor gas	425 to 428
, the use of steam in the gas	429
Production in the blast-furnace, increase in the rate of	342
open-hearth process, increase in the rate of	347
, maximum, by a pair of American converters	361
of iron and steel, increase in	380 to 383
wrought iron, decline in the	344
Progress in the manufacture of iron and steel	313 to 383
Properties of cast iron of 4% carbon	437 to 440
the allotropic states in the iron-carbon com- pounds	215
eutectic	31 to 35, 38 to 43
pearlite series, physical	162
Pseudomorphic crystal, definition of	51
Puddling furnace, comparison of the Roe with the Danks and the Pernot	451, 452
, direct-fired reverberatory	410
, the Pietzka	345
, the Roe	449 to 453
process, the	344 to 347
Purifying processes of iron manufacture	330

Q

Quenching, its influence on the hardening of steel	223 to 230
temperature, its influence on the properties of steel	224

R

Rail-rolling process, the Kennedy-Morrison	266
Rapidity of cooling on segregation, effect of	102 to 112
Rate of production in the blast-furnace, increase in the	342
, in the open-hearth process, increase in the	347
Raw materials for the blast-furnace, the handling of	331
Reactions in freezing and cooling of typical cast irons	277 to 279

	PAGE
Reactions in freezing and transformation of the iron-carbon compounds	197 to 203
the blast-furnace	387, 391 to 395, 405
Recalescence	219
, loss of the hardening power at the	235
Recarburizing process, Darby's	364
Recuperative and regenerative furnaces, comparison of	416, 417
Regeneration, the value of gas	418 to 422
Regenerative and recuperative furnaces, comparison of	416, 417
furnaces, the rise of temperature in	422
Relief-polishing method for preparing metallic sections	17
Removal of phosphorus in the open-hearth process	349
Reversibility	289 to 292
Richards, Professor J. W., his study of the dry-blast process	468
Roberts-Austen's diagram of the iron-carbon compounds	192, 194, 197 to 214
Roe's puddling furnace	449 to 453
Rolling-mill, continuous	378

S

Salt-water, cooling curves of	18, 29, 30
freezing-point curve	58
Saniter develops the structure of austenite	179
Saturation-point curve, its position under various conditions	119 to 133
, its relation to the freezing-point curve	119 to 133
of mercuric bromide and iodide	118
molten binary alloys	117
curves	116 to 147
, determination of	133 to 135
Sauveur, Albert, on classification and definitions of iron and steel	440
on the constitution of the iron-carbon compounds	184, 185
Sauveur's process for the prevention of pipes	368
Scheme of iron manufacture, the general	325 to 329
Segregation	86 to 88, 99 to 116
, effect of diffusion on	100
, effect of freezing on	102 to 112
in steel ingots	372
, microscopic	97
Selective freezing	24, 26, 28, 65, 135, 139 to 147
Self-hardening steels, composition of	324
Series, austenite, of iron-carbon compounds	191
, gray cast iron, of iron-carbon compounds	188, 189
, pearlite, of iron-carbon compounds	184, 188, 189
, uses of the austenite	192
Shaping processes: iron manufacture	330
Siemens furnace, the	350 to 353

	PAGE
Siemens gas producer, the	423 to 425
Siemens-Martin process, the	347 to 356
Silicates, lime-alumina, heat of solidification of	403
Silicon-content of cast iron, effect of reduction in the blast-furnace on the	397
, its influence on blowholes and pipes	370
the formation of graphite	208, 209
Silver-copper alloys, electric conductivity of	157
microstructure of	46 to 49
on the structure of eutectic of	41
-gold alloys, electric conductivity of	155
, freezing-point curve of	67
Size of converters, range in	361
Slag, composition of basic Bessemer	364
, effect of deoxidation on the lime-content of blast-furnace melting-point, its influence on hearth temperature	399 to 401
, regulation of the melting-point of blast-furnace	402
: wrought iron	164, 181
Slags, composition of iron blast-furnace	403
Soaking pit, Gjers	375 to 376
Solid solution alloys, eutectic of	66, 67
type of alloys	64 to 68
solutions	9, 10
, electric conductivity of	154
, heterogeneousness of	13, 66, 88
Solubility, effect of temperature on	115
Sorbite	181, 475
Sorby's method of etching: simple attack	16
Spherulitic structure of eutectics, reasons for	41 to 43
St. Etienne process of compressing ingots, the	374
Statistics, iron and steel . 313 to 315, 342 to 345, 347, 349, 361, 363, 366, 380 to 383	
Stead's brittleness	255
Steam in the gas producer, the use of	429, 453 to 456
, its use in the Mond gas process	453 to 456
Steel and iron, boundary between	447
classification; names and apparatus in which generally made	440, 441
, definitions of the different varieties	442 to 447
, general classification of	166, 167
, heat-treatment of	165
, increase in production of	380 to 383
, magnetic properties of	447, 448
manufacture, cost of	380, 381
, progress in	313 to 383
, metallography of	160 to 217, 475

	PAGE
Steel and iron statistics	313 to 315, 342 to 345, 347, 349, 361, 363, 366, 380 to 383
, structure of	242 to 267
, annealing of hardened	231
, chrome	323
, composition of basic Bessemer	327
Taylor-White	324
typical kinds of	172
, constitution of hardened	164
slowly cooled	184
, conversion into	347 to 366
, cooling curve of high-carbon	220
, effect of the rate of cooling on the hardening of	234, 235
, explanation of the tempering and annealing of	231 to 234
, hardening and tempering of	221 to 240
, heat-refining of	242, 251 to 262
, heat-treatment of	217 to 282
, influence of quenching on the hardening of	224, 225
ingots, defects in	366 to 373
, "draft" fluid compression of	373
, pipes and blowholes in	366 to 373
, segregation in	372
, manganese	317, 320 to 323
, manufacture of	347 to 366
, microstructure of	50, 177, 180, opp. 188, 258
burnt	258
hypo-eutectoid	50
, molybdenum	325
, nickel	316 to 319
, processes, comparison of	365
, physical properties of	162
, stress in	236 to 240.
, tempering of hardened	230
, transformations of	227 to 230
, tungsten	324
Steels, alloy	165, 316 to 325
and irons, their prominent uses	186, 187
, composition of self-hardening	324
Stoichiometric calculations	182, 183
Stoves, hot-blast	338 to 342
Stress in steel	236 to 240
Stratification according to density	44, 45
Structure, its relation to the fracture	244
of austenite, laws concerning the	246 to 248
iron and steel, the	242 to 267
the eutectic	32, 38, 39, 41 to 43

	PAGE
Sulphur-content of cast iron, effect of deoxidation in the blast-furnace on the	397
, the transformations of	225 to 227
Surfusion	20, 35 to 38, 54 to 57
T	
Talbot process, the	355
Taylor gas producer, the	425 to 428
-White steel, composition of	324
Temper-carbon	181
-graphite	181, 282
Temperature and fracture, general laws concerning	245 to 252, 264
grain-size, relation between	246 to 257, 262 to 267
-composition curves	135 to 147
, hearth, of the blast-furnace	398 to 401, 406
, heat-refining	255
, initial, its influence on utilization of heat	460 to 475
in regenerative furnaces	422
, its effect upon brittleness	259
, maximum, its influence on the physical properties of steel	267 to 276
of escaping gases a measure of heat utilization	460
, quenching; its relation to the hardening of steel	223
Temperatures, critical, of steel	20, 194, 214 to 217
Tempering of steel, the	221, 230, 231
Tensile strength of manganese steels	320
nickel steels	318
steel, influence of T^{\max} on the	274 to 276
Terminology of the phase rule	293 to 297
Thermo-electric method of recording cooling curves	22
power	154
Tilting furnace	352 to 354
Tin-antimony alloys, microstructure of	46, 89
-bismuth alloy, microstructure of a	32
alloys, freezing-point curve of	75
, cooling curve of	35
-copper alloy, cooling curve of	37
, microstructure of	72
-lead alloys	43
, electric conductivity of	156
, electromotive force of the	159
, freezing-point curve of	54, 55, 60, 61
Transformation-curves of the iron-carbon compounds	193 to 214
, reactions in, of the iron-carbon compounds	197 to 203
Transformations of steel, the	227 to 230
sulphur, the	225 to 227

Index

495

	PAGE
Transition stages between austenite and pearlite, note on	475
Troostite	180, 475
Tungsten steel	324

U

Uehling's pig-casting machine	335, 336
Unselective freezing	28
Uses of the austenite series of the iron-carbon compounds	192
, prominent, of the various irons and steels	186, 187

W

Walrand-Legenisel modification of the Bessemer process	362
Water-cooling blocks, Gayley's	336, 337
Wellman charging system, the	354
Wellman's tilting furnace	354
Weyl's method of attack for metallic sections	16
White cast iron, constitution of	163
White cast iron, genesis of	435 to 437
Whitwell hot-blast stove	339, 340
Whitworth process of compressing ingots, the	373
Wright, C. R. A., method for determining saturation-point curves	134
Wrought iron, constitution of	164
, decline in the production of	344
, definition of	447
, fracture of barked	243
, its distinctive properties	168 to 170
, manufacture of	343 to 347
, microstructure of	169
Wood's car-casting system	358 to 361



METALLOGRAPHY

Taught by Correspondence in Seventeen Lessons

UNSOLICITED COMMENTS. "Will you allow me to say how much I am enjoying and profiting by the lessons which you are sending from time to time. I shall be very sorry when they are finished. I think your course fills a great need; before taking it up I had done a great deal of reading on the subject, and had derived very little benefit from it. It is the working of the experiments you suggest and the fact that any points not understood, or questions arising may be referred to you, that make the lessons so valuable. I understand the practical part of the manufacture of iron and steel more or less thoroughly, but this was a fresh field for me, which I realized at the time was being taken up by all progressive people. Your course, supplemented by general reading — and there is a great deal of literature easily available — enables a man who is busy all day to get a thorough knowledge of the subject, and I know of no other way by which he could obtain it."

ARTHUR SIMONSON,

TROPENAS STEEL PROCESS CO.,

PHILADELPHIA, PA.

JANUARY 25, 1905.

"As I am about to complete the work of your 'Course in Metallography,' I desire to thank you for the courtesy with which you have conducted my instruction.

"The course has enabled me to read understandingly, work that before was entirely beyond me, and from almost the beginning I have used the knowledge obtained to decided advantage in our laboratory.

"I feel that the advantages to be derived from the 'Course in Metallography' and 'The Metallographist' cannot be overestimated."

R. R. WARFEL, Chemist,

BABCOCK & WILCOX Co.,

BAYONNE, N. J.

MAY 15, 1905.

"I wish also to express high appreciation of the value of the Course. It has satisfactorily explained many points in metallurgy which were not clear to me, and has afforded information for which I have vainly sought in other works on metallurgy of iron and steel."

J. E. ISENBERG,

Chemist and Metallurgist, STANLEY G. FLAGG CO.,

POTTSTOWN, PA.

DECEMBER 5, 1905.

STUDENTS IN MANY COUNTRIES. Students in the following countries are taking our Correspondence Course in Metallography: United States, Canada, England, France, Germany, Belgium, Italy, Sweden, Austria and Russia.

CLUB RATES. We offer liberal club rates to classes formed in the same locality.

For further particulars address

ALBERT SAUVEUR

ROTCH BUILDING

CAMBRIDGE, MASS.

The Iron and Steel Magazine

Special Offers to Subscribers		Regular Price	Special Offer
1	The Iron and Steel Magazine for one year . . . Metallurgical Laboratory Notes, by Prof. H. M. Howe	\$5.00 2.50 <hr/> 7.50	\$6.1
2	The Iron and Steel Magazine for one year . . . Iron, Steel and Other Alloys, by Prof. H. M. Howe	5.00 5.00 <hr/> 10.00	8.0
3	The Iron and Steel Magazine for one year . . . The Iron and Steel Magazine for 1905. Two bound volumes (1,265 pages)	5.00 7.00 <hr/> 12.00	9.5
4	The Iron and Steel Magazine for one year . . . The Iron and Steel Magazine for 1904 and 1905. Four bound volumes (over 600 pages each) . . .	5.00 14.00 <hr/> 19.00	14.0
5	The Iron and Steel Magazine for one year . . . Complete set of six bound volumes of The Metalligraphist	5.00 21.00 <hr/> 26.00	20.0
6	The Iron and Steel Magazine for one year . . . Complete set of six bound volumes of The Metalligraphist The Iron and Steel Magazine for 1904 and 1905. Four bound volumes	5.00 21.00 14.00 <hr/> 40.00	30.0

THE IRON AND STEEL MAGAZINE

Rotch Building, Cambridge, Mass.

Enclosed please find \$..... for which send the IRON AND STEEL MAGAZINE for one year, and..... as per Offer No.....

Name.....

Address.....



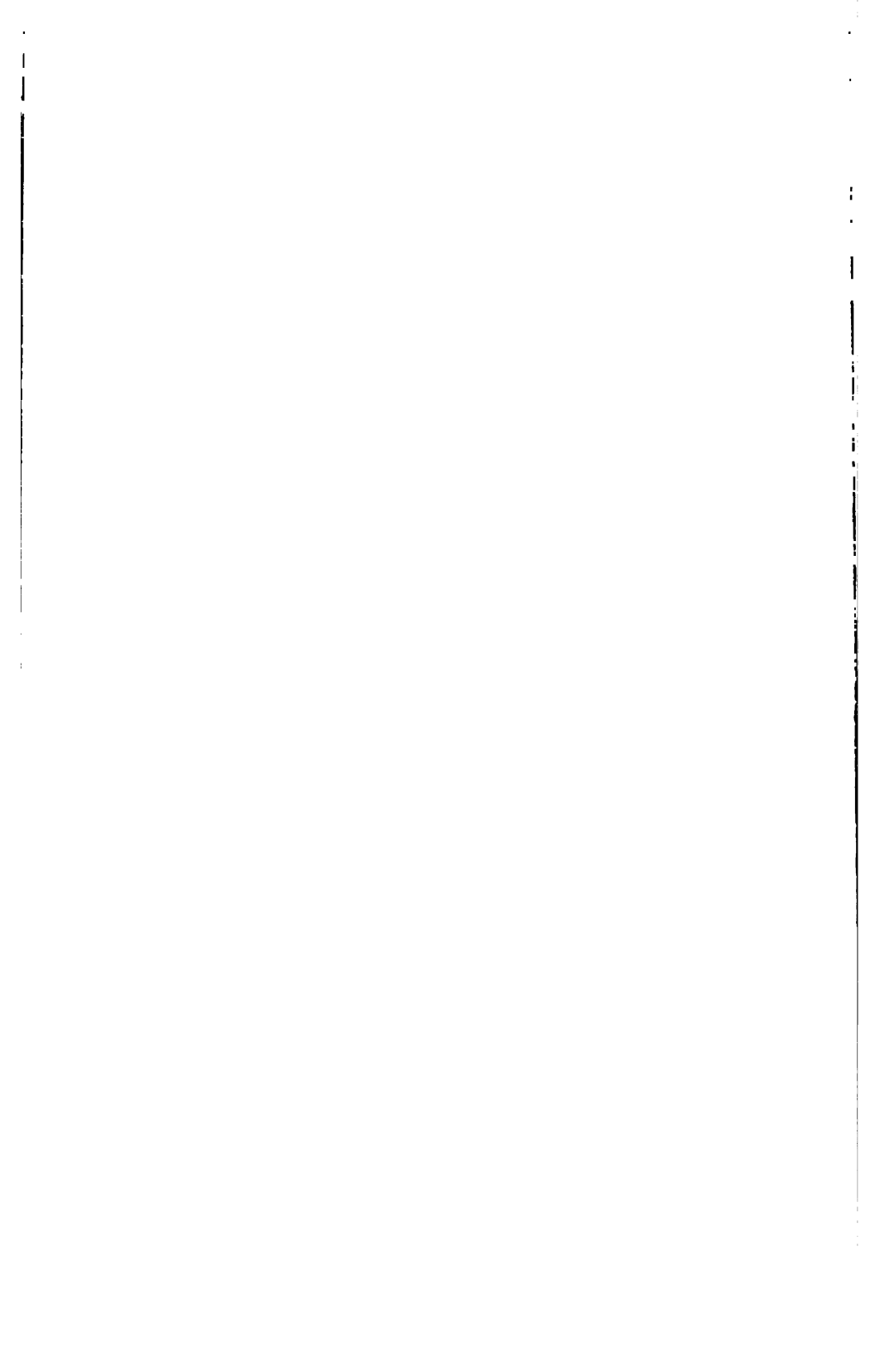



THIS BOOK IS DUE ON THE LAST DATE
STAMPED BELOW

AN INITIAL FINE OF 25 CENTS
WILL BE ASSESSED FOR FAILURE TO RETURN
THIS BOOK ON THE DATE DUE. THE PENALTY
WILL INCREASE TO 50 CENTS ON THE FOURTH
DAY AND TO \$1.00 ON THE SEVENTH DAY
OVERDUE.

NOV 22 1941

MAY 27 1947

22 NOV 1945

REC'D LD

OCT 20 1967

2 Aug '65 VBX

REC'D LD

JUL 27 '65 - 9 AM

YC 68476

154953

TN
690
H8
1900

THE UNIVERSITY OF CALIFORNIA LIBRARY

